

XtendLan[®]

XL-VT1101

**1-Channel Video Digital Optical
Converter (mini-type)**

User's Manual



TABLE OF CONTENTS

TABLE OF CONTENTS	1
MANUAL FOR SAFELY-USING	2
PRODUCT OVERVIEW	3
PRODUCT CHARACTERISTICS	3
TECHNOLOGY CHARACTERISTICS	4
OPTICAL CHARACTERISTICS	4
VIDEO CHARACTERISTICS	4
DATA CHARACTERISTICS	4
OTHER NORMAL CHARACTERISTICS	4
APPLICATIONS	5
PANEL OF OPTICAL TRANSMITER	5
TABLE OF FRONT PANEL	5
TABLE OF BACK PANEL	6
PANEL OF OPTICAL RECEIVER	6
TABLE OF FRONT PANEL	6
TABLE OF BACK PANEL	7
SPECIFICATIONS FOR POWER SUPPLY	7
INSTALLATION	8
NOTE BEFORE INSTALLATION	8
INSTALLATION STEPS	8
EXTERNAL DIMENSIONS	9
NETWORKING SCHEME	9
RESPONSIBILITY NOTE	10

MANUAL FOR SAFELY USING



BE CAREFUL !

WARNING THIS LABEL REMINDS YOU THIS EQUIPMENT MAY DO HARM TO YOU .



TAKE CARE OF ELECTRIC SHOCK !

WARNING THIS LABEL REMINDS YOU THIS EQUIPMENT MAY DO HARM TO YOU OR YOUR PROPERTY .

Ⓞ MANUAL FOR SAFELY-USING

In order to prevent any damages to the property of you or others ,do please follow the manual for safely using . Although this equipment is designed reliably and safely , please try your best to prevent any damages to it .

1. Please read this manual carefully and keep it well for your further information .
2. Please place the equipment where it will not be subjected to extreme temperatures or humidity as this equipment is electric device .
3. Do not try to knot the cables of power supply or put anything on them . Please place them where it will not be touched easily .
4. Please make sure the connections between power plug and other devices are fully valid .
5. Please follow the marks on the equipment when connect the power supply , and the power supply should meet the following rules :
 - (1.) Input AC :220V (165V-260V) ,50Hz
Input DC :-48V , -24V , -12V
 - (2.) Output DC :5V ,2A
(Remark:This equipment can be used with standard power adaptor only.)
6. Please shut down the power supply immediately and get in touch with us or your authorized reseller when the following things happen :
 - (1.)The equipment is drowned in water or another liquid.
 - (2.)The equipment or the coat is broken down .
 - (3.)The equipment works abnormally .
 - (4.)The equipment is smelled or noisy or smoky .
7. Do not try to maintain the equipment by yourself , unless there are clear instructions in this manual.
8. Please install special device to prevent damages caused by lightning when use the equipment in open outdoor .

PRODUCT OVERVIEW

Our 1-channel video digital optical converter adopt the advanced international digital video and optical fiber transmission technology, and implement the transmission of real-time & synchronization, no-distortion and high quality to 1-channel video signal on the single-core optical fiber. 1-channel video digital optical converter adopt the full digital video non-compression transmission technology and high quality video effect, which can meet the user's requirement; the plug-and-play design makes the installation more convenient and easier, the LED design helps the user to know

the working status easily, and it is unnecessary to implement the spot adjustment; its optical module and core circuit adopt the imported components that have high stability, and all optical & electrical interfaces conform to the international standards, which is applied to the different working Environment.



PRODUCT CHARACTERISTICS

- ◎ 10-bit digital code and non-compression type video transmission
- ◎ Support any high-resolution video signal
- ◎ Automatic compatible PAL, NTSC and SECAM video system
- ◎ Power supply and other parameter state indication, which can monitor the operation condition of system
- ◎ Support no-damage regenerative trunk of video
- ◎ Constant input optical power, and large dynamic range, and it is unnecessary to implement the adjustment of spot electrics or optics when using
- ◎ Special ASIC design .
- ◎ Industry-grade of operating temperature from -40°C to 85°C, which is applied to the different working environment
- ◎ Hot-swap function
- ◎ Can be installed in 19 inches rack-mounted chassis (4U)

TECHNOLOGY CHARACTERISTICS

OPTICAL CHARACTERISTICS

Fiber connector	FC/SC/ST
Transmission distance	550M-80Km
Wavelength	1310/1550nm

VIDEO CHARACTERISTICS

Video interface form:	BNC
Video input / output impedance:	75 Ω(imbalance)
Video input/output voltage :	1V pp (typical value) 1.5 V pp(max value)
Bandwidth of video :	5MHz-7.5 MHz
Automatic compatible video system :	PAL SECAM NTSC
Differential gain:	(10%-90%APL) DG <1% (typical value)
Differential phase:	(10%-90%APL) DP <0.7 ° (typical value)
Weighted signal-to-noise ratio:	S/N ≥ 70dB

DATA CHARACTERISTICS

Interface Port:	RJ-45 industrial standard port
Interface Signal Type:	RS-232 /RS-422 /RS-485 /Manchester
Code rate:	0~400Kbps
BER:	≤ 10 ⁻⁹

OTHER NORMAL CHARACTERISTICS

Operating Temperature	-40°C~+85°C
Humidity	0~95% non-condensing
Operating Voltage	DC 5V/2A
MTBF:	≥ 10 ⁵ hours

APPLICATIONS

- ⊙ Intelligent Transportation System
- ⊙ Connection of Sub-network for Surveillance Center
- ⊙ Public Security Surveillance
- ⊙ High Way & Toll Station Surveillance
- ⊙ High Quality Video Conference
- ⊙ Industrial Closed Circuit Television Surveillance
- ⊙ Coliseum using for TV-live ,audio transmission

PANEL OF OPTICAL TRANSMITER

TABLE OF FRONT PANEL

Please see the Video interface port BNC , fiber port ,LED lamps and data port as the following table showing:

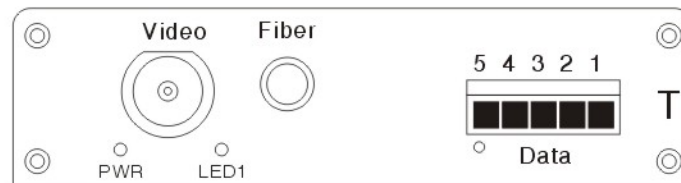

Video interface :

BNC ,Video signals input

Fiber port :

Interface for optical fiber **(Warning :Do not see directly the fiber interfact when using !)**

LED lamps :

PWR : LED lamp for power supply (when turn the power on ,this lamp will be on and red ,when shut down the power ,this lamp will be off .)

LED 1 : LED lamp for video (when get video signals,this lamp will be on,when no video signals ,this lamp will be off or blink .)

TABLE OF BACK PANEL

Pease see the power interface as the following table showing:



Video digital optical converter on this type use external power supply of DC 5V .

PANEL OF OPTICAL RECEIVER

TABLE OF FRONT PANEL

Please see the Video interface port BNC , fiber port ,LED lamps and data port as the following table showing:

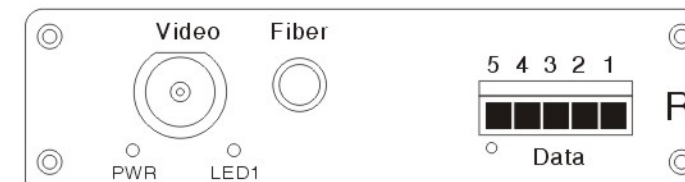

Video interface :

BNC ,Video signals input

Fiber port :

Interface for optical fiber **(Warning :Do not see directly the fiber interfact when using !)**

LED lamps :

PWR : LED lamp for power supply (when turn the power on ,this lamp will be on and red ,when shut down the power ,this lamp will be off .)

LED 1 : LED lamp for video (when get video signals,this lamp will be on,when no video signals ,this lamp will be off or blink .)

TABLE OF BACK PANEL

The optical receiver has the same back panel as the optical transmitter , please kindly see this on TABLE OF BACK PANEL for optical transmitter .

SPECIFICATIONS FOR POWER SUPPLY

If you want to prepare power supply by youeself ,please make sure the power supply you select meet the following requirements :

1. AC power supply ,power upto 5W , output 5V/2A .
2. Electric Ripple \leq 100 mV
3. The power supply you select should be applied to the working environment.

INSTALLATION

1. NOTE BEFORE INSTALLATION

- (1.) When you unpack this product package ,you will find the items listed below : 1pc optical transmitter ; 1pc optical receiver ; 2pcs power adaptors (no this item when user prepare power supply by theirselves.) ;1pc user's manual copy . Please inspect the contents ,and report anyapparent damage or missing items immediately to your authorized reseller .
- (2.)Please read this manual carefully before installation .
- (3.)Please read the manual for safely-using carefully .
- (4.)Do not try to dismantle the equipment without authorization form us .
- (5.)Please check the lables of item number on the equipment carefully .(By "T" it means optical transmitter , by "R" it means optical receiver .)
- (6.)The optical transmitter is the device to change video signals ,audio signals or data signals into optical signals and then transmit with optical fiber . So this equipment should be connected to camera with rotate-operation device or other video options .
- (7.)The optical receiver is the device to receive optical signals and then change them into video signals ,audio signals or data signals . So this equipment should be connected to monitor or monitor-matrix .
- (8.)The video interface of optical transmitter has corresponding vide interface of the optical receiver .

2. INSTALLATION STEPS

- (1.) Connect the video interface of optical transmitter to camera with rotate-operation device or other video options . Then connect the optical fiber to the fiber port , and connect the power supply .
- (2.) Connect the video interface of optical receiver to monitor or monitor-matrix . Then connect the optical fiber to the fiber port , and connect the power supply .

EXTERNAL DIMENSIONS

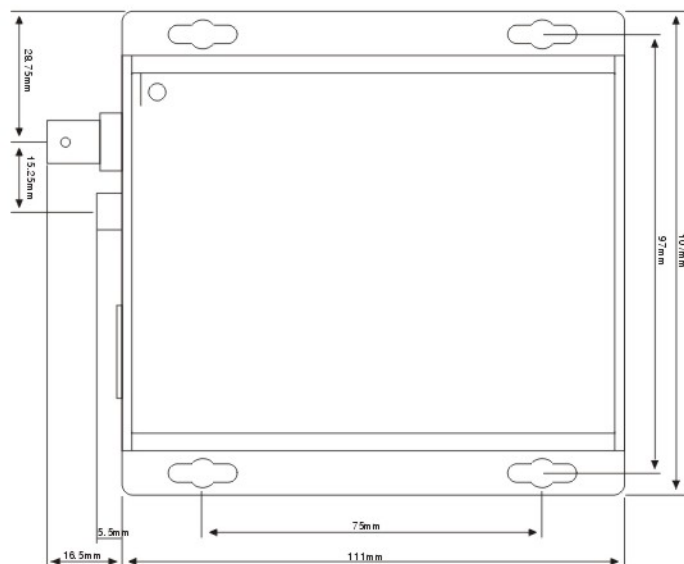

NETWORKING SCHEME

Point to point link

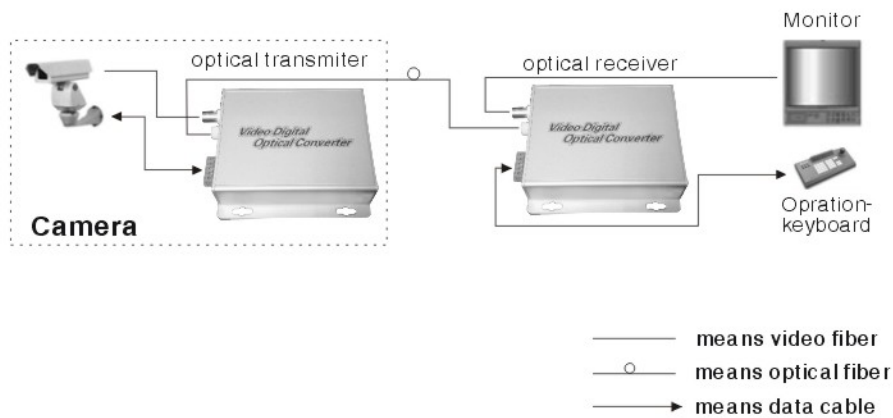

RESPONSIBILITY NOTE

- (1.) The user should cover the damage during transport to equipment resend for maintained at the user's own expense .
- (2.) Please contact your authorized reseller immediately , if there is any damage to the equipment during transport .
- (3.) If you want to prepare power supply by youeself ,please make sure the power supply you select meet the requirements given by this manual .We will not cover the damage caused by your using unqualified power supply .
- (4.) Do please follow this manual when using the power supply .
- (5.) All rights reserved. No part of this manual can be reproduced , or transmitted in any form or by any means, without authorization form us .
- (6.) We will not cover the damage to the equipment or any person casued by your changing the equipment or this manual in any form without authorization from us .
- (7.) We will change the equipment for new ones if it can not work normally because of the quility itself within the warranty time . We will keep the old ones .
- (8.) The packages of the equipment meet the requests of environmental protection ,should be recycled .

Attention : If there are any printing mistakes in this manual ,the right to explain is reserved.And the pictures of equipment appearance in this manual are just for user's information,the final equipment appearance depends on reality products,if there are any improvements on techonlogy ,we will be sorry for won't inform you again .

Introduction chart for production

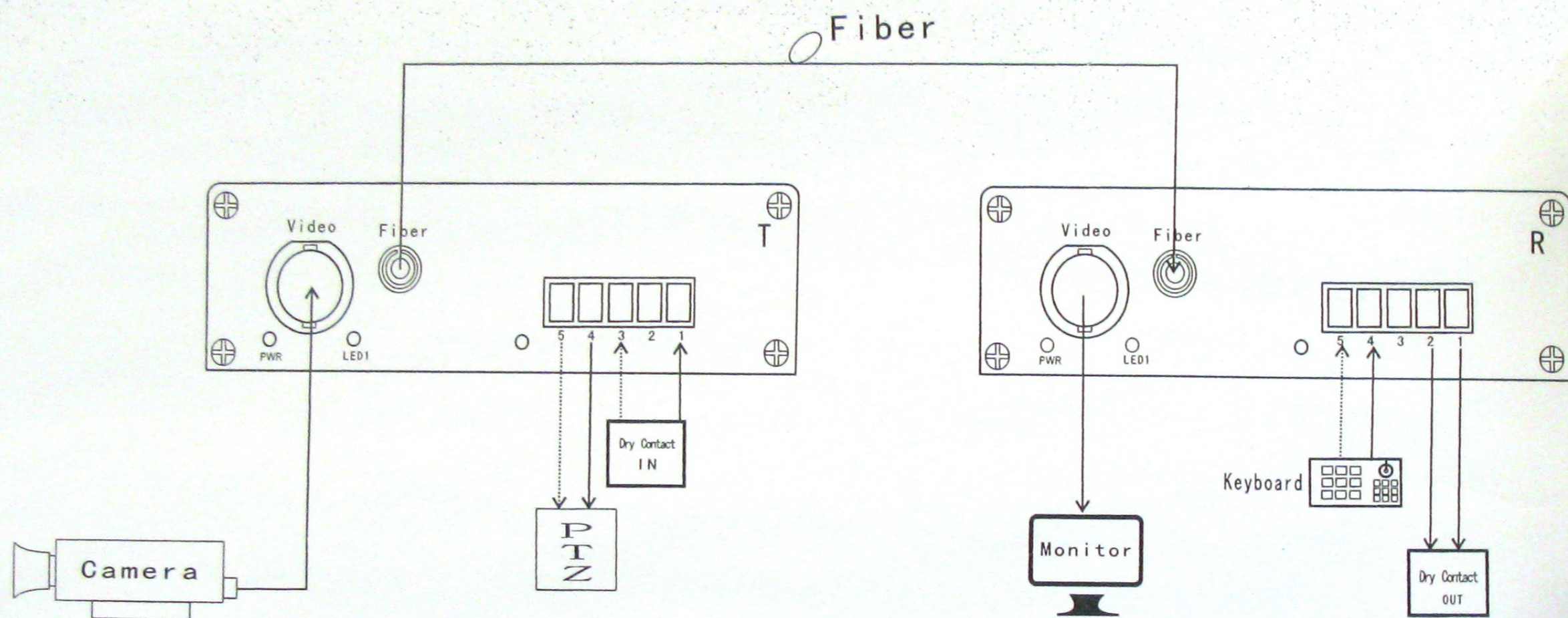



Video Optical Multiplexer 116#V1.3

Part Number: XL-VT1101T1
 Distance: 0~20KM
 Video port: 1 Channel Transmitter
 Data Control: 1 Channel Return Data RS485
 Dry Contact: 1 Channel Positive Dry Contact
 Wavelength: 1310nm/1550nm
 Adapter: AC 100V~240V DC 5V1.2A
 Dimension: 11*8.5*2.7cm

S/N: 
 CS150303XW0015
 RoHS 
 VT1101T1 opto konvert 1x Video, 1x COM, 1x I/O, TX 
 XL-VT1101T1 10 3 2015
 FN 24944.24929
 SN 24929.2 XtendLan 

Attention:

In order to prevent the induced electricity to enter into the video converter's interior through the video coaxial cable's shielding layer copper screen which should as far as possible when the camera and video converter's distance is far away from each others, please adopt the back to back connection mode, reduce the video coaxial cable's length as far as possible, avoid the electric cable because of having the induction opportunity with the earth contact.

Statement: Label with  and without  of the optical video can't be use in pairs.

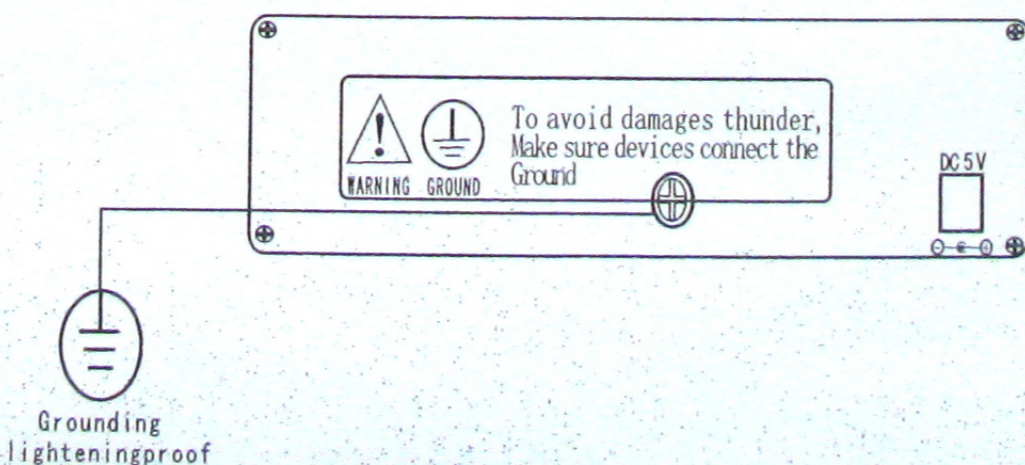

Linkable

Dry Contact/Audio/Data
 Linetype -
 Linetype ——— +