

# DPM-IP71R

## 7 inch Guard Station

COLOR TFT TOUCH SCREEN WITH HANDSET

### OPERATION MANUAL

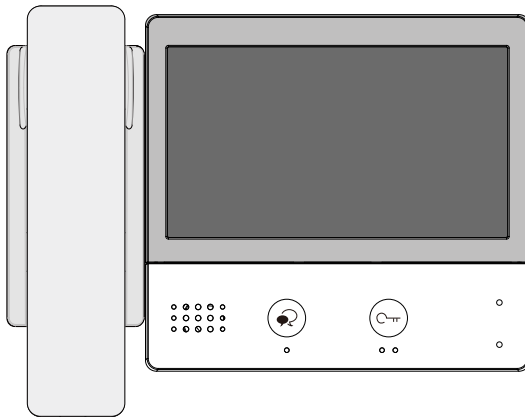

**XtendLan**

- Please read this manual carefully before using the product you purchase, and keep it well for future use.
- Please note that images and sketch maps in this manual may be different from the actual product.

## PRECAUTIONS

- Slots or openings in the back of the monitor, are provided for ventilation and to ensure reliable operation of the video monitor or equipment and to protect it from overheating. These openings must not be blocked or covered. The monitor should never be placed near or over a radiator or heat register and should not be placed in a built-in installation such as a bookcase unless proper ventilation is provided.
- All parts should be protected from violence vibration. And not allow be impacting, knocking and dropping.
- For clean the LCD screen, using hands or wet cloth is forbidden.
- Please do the cleanness with soft cotton cloth, please do not use the organic or chemical clean impregnate. If necessary, please use pure water or dilute soap water to clean the dust.
- Image distortion may occur if the video door phone is mounted too close to magnetic field e. g. Microwaves, TV, computer etc.
- Please keep away the video door monitor from wet, high temperature, dust, and caustic and oxidation gas in order to avoid any unpredictable damage.
- Do NOT open the device in any condition, call the administrator for help if there is any problem or malfunction happens.

# CONTENTS

<b>PARTS AND FUNCTIONS</b> .....	<b>4</b>
Part Names.....	4
Mounting.....	5
Screen.....	6
<b>BASIC OPERATIONS</b> .....	<b>7</b>
Answering a call.....	7
Basic operation based on Namelist.....	8
Namelist configured.....	8
Select a user or a Guard Station to be called.....	8
Select a video door station to be monitored.....	9
Select a door station to be released the lock.....	9
Basic operation by Input code.....	10
Call a user or a Guard Station.....	10
Monitor a video door station.....	10
Release a door lock.....	11
No Disturb Mode.....	11
Divert Calls.....	12
View Call Record.....	12
Viewing Videos.....	13
Playback.....	14
<b>SETUP INSTRUCTIONS</b> .....	<b>15</b>
Setting date and time.....	15
Setting monitor time.....	15
Setting ring tone & ring volume.....	16
Add IP Camera.....	16
Delete IP Camera.....	17
Specification.....	17

# PARTS AND FUNCTIONS

## Part Names

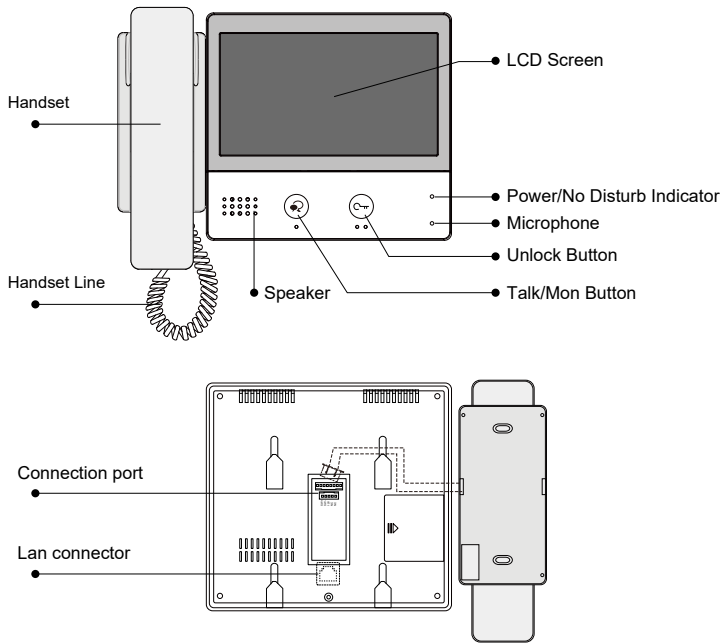

## Key functions

Item	Description
LCD screen	<ul style="list-style-type: none"> <li>• See the menu details</li> <li>• Display videos and images</li> </ul>
Handset	<ul style="list-style-type: none"> <li>• Pick up to answer the call</li> </ul>
Power/No Disturb indicator	<ul style="list-style-type: none"> <li>• Show the power status of the system.</li> <li>• Show the no disturb status.</li> </ul>
Microphone	<ul style="list-style-type: none"> <li>• Transmit audio from one station to other stations.</li> </ul>
Unlock button	<ul style="list-style-type: none"> <li>• Press to release the door.</li> </ul>
Talk/Mon button	<ul style="list-style-type: none"> <li>• Press to communicate hands free with visitor;</li> <li>• Press to view the outdoor condition in standby mode.</li> </ul>
Speaker	<ul style="list-style-type: none"> <li>• Send out voice from the visitor.</li> </ul>
Connection port	<ul style="list-style-type: none"> <li>• Use to connect external devices to the indoor station.</li> </ul>
Lan connector	<ul style="list-style-type: none"> <li>• Use to connect the indoor station to the network.</li> </ul>

\* Monitor/Home/Call/Manual record/Unlock button will be light up when power on for the unit.

# PARTS AND FUNCTIONS

---

## Mounting

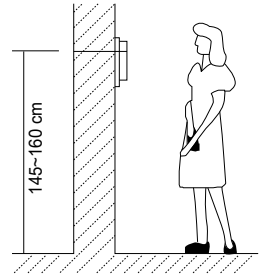
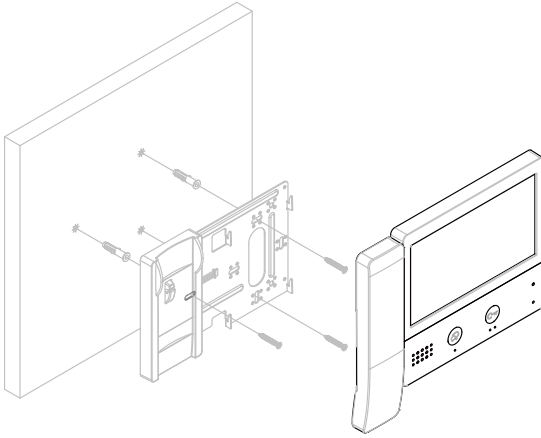

The installation height is suggested to 145~160cm.

1. Use screws to fasten the mounting bracket to the wall with mounting box.
2. Connect the 2 wire cables to the unit.
3. Mount the unit to the mounting bracket, make sure the unit is absolutely attached to the mounting bracket.

# PARTS AND FUNCTIONS

## Screen

### Main screen

The Main menu is your starting point for using all the applications on your monitor.

Touch anywhere of the screen on monitor in standby mode, the Main menu will appear as follows:

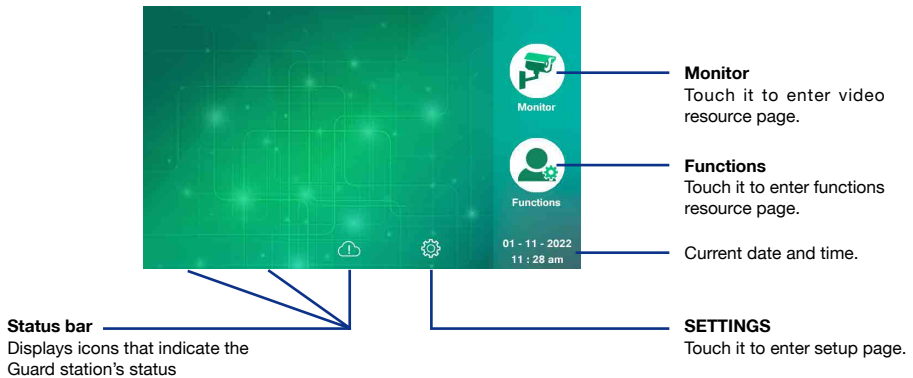

### Functions screen

On Main menu page, touch  **[Functions]** icon to display the Functions screen.

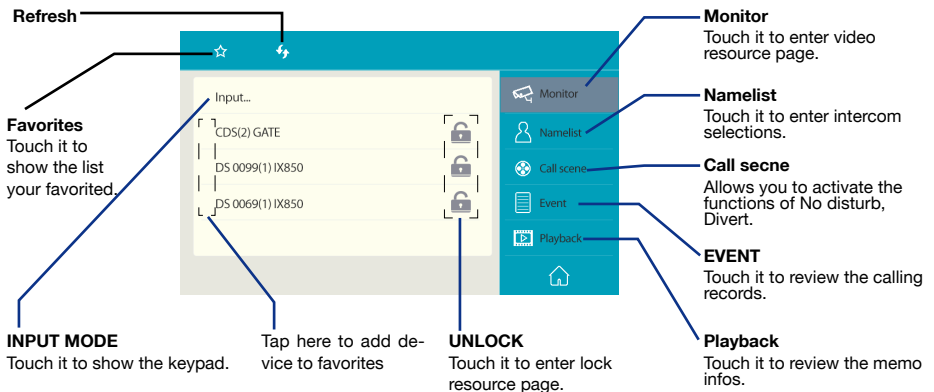

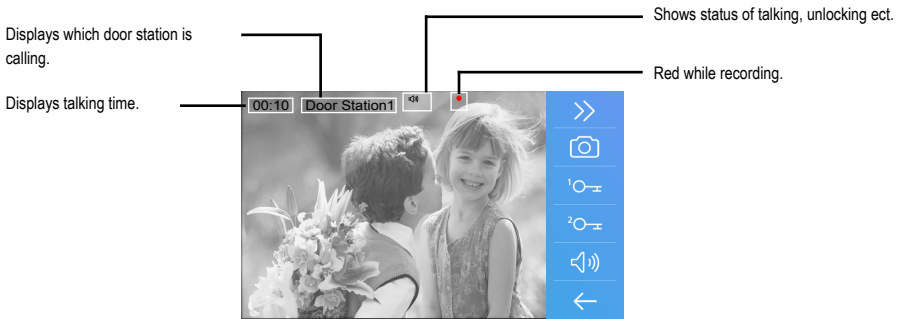

# BASIC OPERATIONS

## Communication screen



## Answering a call

- When receiving a call, the call tone sounds, video will be displayed on the screen if the source is a Video Door Station, and one video will be recorded for 10 seconds automatically if there is video (Note: If without SD card, picture will be recorded; If with SD card, video will be recorded) .
- Pick up handset to communicate with the caller for 90 seconds.
- While communication, press  /  **[Unlock]** button to release the corresponding door lock.
- When the communication ends, hang up handset.

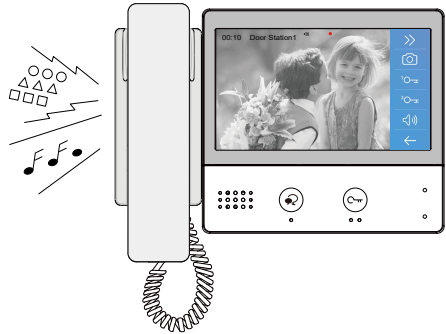

- 1.If nobody answers the call, the screen will be turned off automatically after 30 seconds.
- 2.The image will not be displayed when receiving a call from User or Other Guard Station.
- 3.Manual recording is forbidden during auto recording.
- 4.While receiving a call,other calling is forbidden.
- 5.Communication also ends automatically after 90 seconds.

# BASIC OPERATIONS

## Basic operation based on Namelist

### 1.Namelist configured

In default, the Namelist is not included.It should be configured by Building/Guard unit number .The following instructions are available in the condition of the namelist is created.

1.On Main menu, touch  **[Setting]** icon ->**Installer->Call\_Nbr**. And it will appear as follow: .

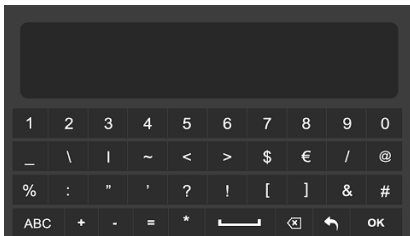

2.Input the installer password (default:66666666), press 'OK' to confirm.

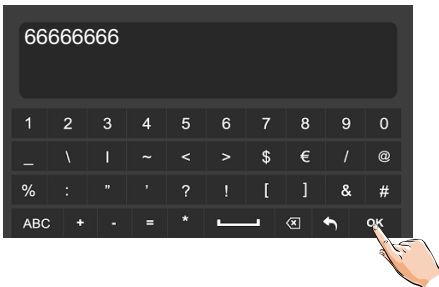

3.Select **BD\_Nbr/GL\_Nbr**.

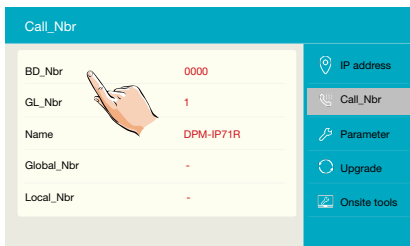

4.Input the building number(ex:0000),and press 'OK' to confirm.

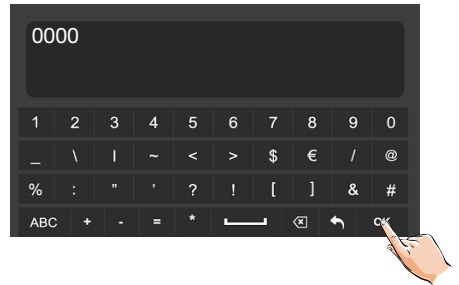

### 2.Select a User or a Guard Station to be called

1.On Functions menu, touch **[Namelist]** item to display **Namelist**.

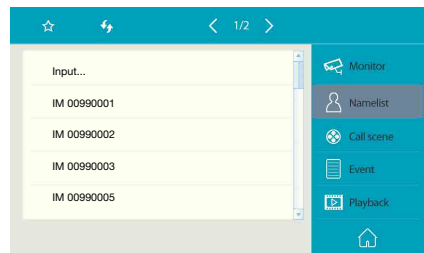

2.Select a Name by touching it,calling is activated immediately.No image will be displayed on screen.

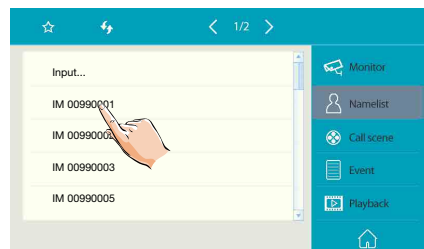



# BASIC OPERATIONS

3.If nobody answers the call within 30 seconds,it will stop calling automatically and shut off the screen.Or touch  icon to stop calling directly.



4.If the call is answered,communication is starting.

5.When the communication, hang up handset or press  [Close] button.

## 3.Select a Video Door Station to be monitored

1.On Functions menu, select **[Monitor]** to display **Door station** list.

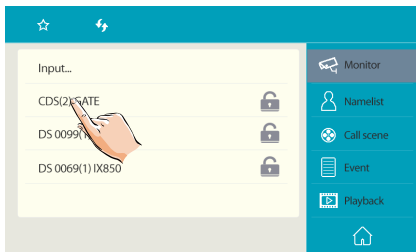



2.Select a Video Door Station by touching it,monitoring is activated immediately.The monitor time is 30 seconds.

3.The image of outdoor condition will be displayed on screen,see as follow:



4.During monitoring, these operations are available:

-Pick up handset to talk with visitor;

-Press  /  **[Unlock]** button to release the door lock;

-Press  [Close] button to end monitoring.

## 4.Select a door station to be released the lock

1.On Functions menu, select **[Monitor]** to display **Door Station** list.

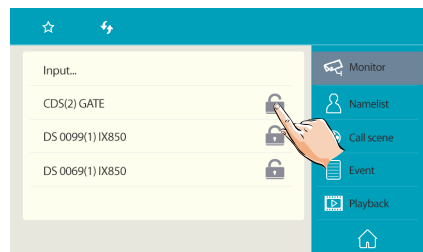

2.Select a Door Station by touching  **[Unlock]** icon to release the corresponding lock.

# BASIC OPERATIONS

## Basic operation by Input code

The another way to activate the functions of calling, monitoring, unlocking is by inputting code via the keypad on screen.

### 1.Call a User or a Guard Station

On Functions menu, select **[Namelis]**, touch **[Input]** to display **Search screen**.

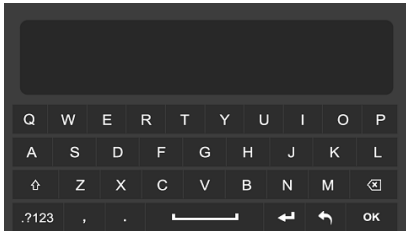

#### Search by digital numbers:

For example,maybe you just remember the room code including the numbers of 32,input the code 32 on input box,then touch the key “**OK**”, all Namelist which is including the code of 32 will be displayed.

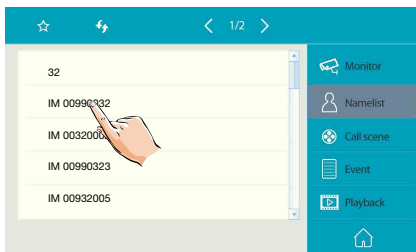

Select the target you want to activate calling.

#### Search by name:

Maybe you just know the name of User or Guard Station. For example,input the name “jim” on input box,then touch the key “**OK**”, all Users or Guard Stations called “jim” will be displayed.

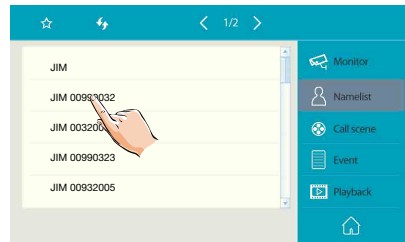

Select the target you want to activate calling.

### 2.Monitor a Video Door Station

1.On Functions menu, select **[Monitor]**, touch **[Input]** icon to display **Search screen**.

2.The inputting method is the same as the section of **Calling User or Guard Station**.

3.Select the Video Door Station you want to activate monitoring.

# BASIC OPERATIONS

---

## 3.Release a door lock

- 1.On Functions menu, select **[Monitor]**, touch **[Input]** icon to display **Search screen**.
- 2.The inputting method is the same as the section of **Calling User or Guard Station**.
- 3.Select the Door Station you want, then press  **[Unlock]** button to open the corresponding door.

## No Disturb Mode

During a certain period, if you don't want to be disturbed, you can go to set DND mode.

1. From the Functions menu, select "Call scene" item.
2. Select the desired tap.
  - No disturb 8H: Set to no disturb mode 8 hours.
  - No disturb always: Set to no disturb mode always.

Note:

\* The no disturb indicator turns from green to red, to indicate that the no disturb function has been activated.

\* This function will perform immediately if selected, and the status bar on main menu interface will show "" icon.

# BASIC OPERATIONS

---

## Divert Calls

The calling from door station can be diverted to your smart phone. please note that this function should be supported by SIP network.



1. From the Functions menu, select "**Call scene**" item.
2. Select the desired tap.
  - Divert call if no answer: If nobody answers the call in 30s when receives call from door station, diverts the call to the smart phone. At this mode, the monitor will always open the screen and show image from door station during diverted, if the monitor answers the call at this time, diverted will conclude at once.
  - Divert call always: When receives call from door station, diverts the call to smart phone directly. At this mode, the monitor will shut off the screen after diverting successfully, but you can still use it in normal.

Note:

- \* If divert the call to smart phone via Sip sever, need to choose one.
- \* This function will perform immediately if selected, and the status bar on main menu interface will show "📞" icon.

## View Call Record

The Guard Station records information about calls you have answered, missed, and made, and saves it in the call record. See the following steps to view the call record.





1. From the Functions menu, select "**Event**" item.
2. Select the desired tap.
  -  Miss called: Displays calls you received but did not answer.
  -  Incoming called: Displays calls you answered.
  -  Outgoing called: Displays calls you made.
3. Browse the call record as needed.
4. When finished, tap ← , return to previous menu.

# BASIC OPERATIONS

---

## Controlling Records

The following controls are available by tapping the screen while playing a record.

-  • Plays the record.
-  • Plays the next record.
-  • Plays the previous record.
-  • Delete record.
-  • Delete confirm.

## View Videos

Videos are possible to be recorded, and both automatic recording and manual recording are available. To record videos,SD card is needed.

### Automatic recording

Recording starts immediately when receiving a call.

- While recording, “ ● ” displays on the screen.
- Capture one video automatically for each calling.

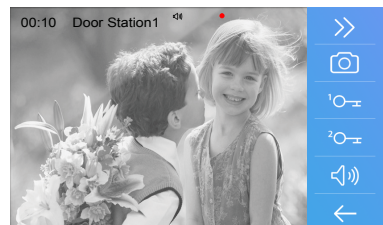

# BASIC OPERATIONS

---

The recorded videos are stored in SD card directly.

\* Max. 32G Micro SD card is supported.

## Note:

\* Automatic recording function cannot be cancelled.

\* Automatic recording does not available while monitoring a door station. To save videos while monitoring, see manual recording below.

## Manual recording

While be called,talking or monitoring,Touch  button when an image is displayed.

## Note:

\* Manual recording is available at any time.

\* Manual recording cannot be performed during automatic recording.

- 1.The auto recording time limited is 10s. The videos will be saved on micro SD card directly.
- 2.The manual recording time is the time for ending manual recording,max.10s for each manual recording.
3. A brand new SD card needs to be formatted by the monitor, then it can be used for video recording.

## Playback

The recorded videos can be playback on Guard Station. Follow the steps:

- On Functions menu page, select [**Playback**], most recent recordings are displayed.
- Touch "<" or ">" to scroll through recordings,touch "🗑️" to delete current video.

## To stop



Touch  icon on the screen during play to return to last page.

Press  [**Home**] button to return to main menu page.

# SETUP INSTRUCTIONS

## Setting date and time

You can correct the current date and time any time by following the procedure below.



1. On main menu page, touch  **[Setting]** icon -> **[General]** -> **[Date&Time]**, to enter **Clock setting** page (or Click on the lower right corner of the screen).
2. Touch the setting target of Date mode, Time mode, Date, Time to adjust.
3. When the setting has finished, touch  to save the settings.





## Setting monitor time

The monitor time can be changed at any time. The setting range is 30s,60s,90s,120s,150,180s ,210s,240s,270s,300s.

\* 30s is the default monitor time.

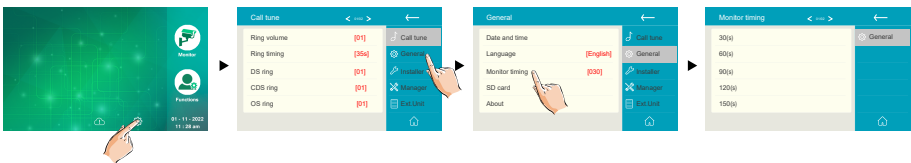
1. On main menu page, touch  **[Setting]** icon -> **[General]** -> **[Monitor timing]**, to enter **Monitor timing** page.
2. Select the times you want.
3. When the setting has finished, touch  to save the settings.



\* Press  **[Home]** button to return to main menu page or touch " **Return**" key to return to last page.

# SETUP INSTRUCTIONS

## Setting ring tone&ring volume

The ring call tone can be set individually to distinguish different calling source. Total 22 tones can be selected.

1.On main menu page, touch  **[Setting]** icon ->**[Ring volume]/[DS ring]/[CDS ring]/[OS ring]/[Message ring]/[Doorbell ring]/[Intercom ring]/[Innercall ring]/[Alarm ring]**.

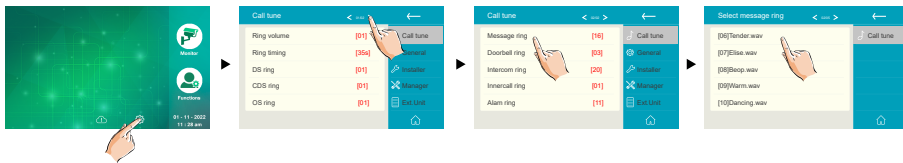

\* After selected the value,touch ← to save and perform the settings.

## Add IP Camera

On main menu page, touch  **[Setting]** icon ->**[Ext.Unit]->[IPC camera]->[Add]->[Add by search]/[Add by manual]**.

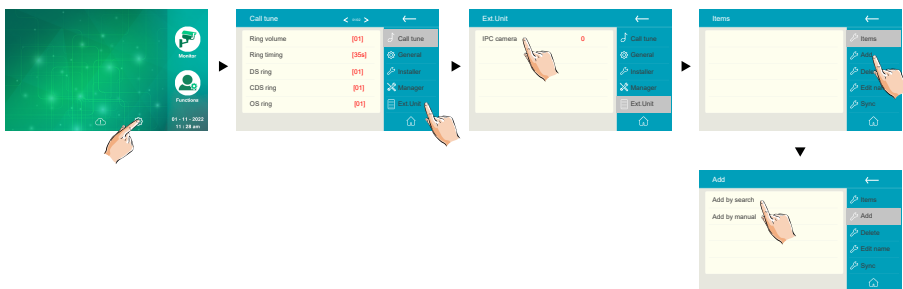



# SETUP INSTRUCTIONS

## Delete IP Camera

On main menu page, touch  [Setting] icon -> [Ext.Unit]-> [IPC camera]-> [Delete].

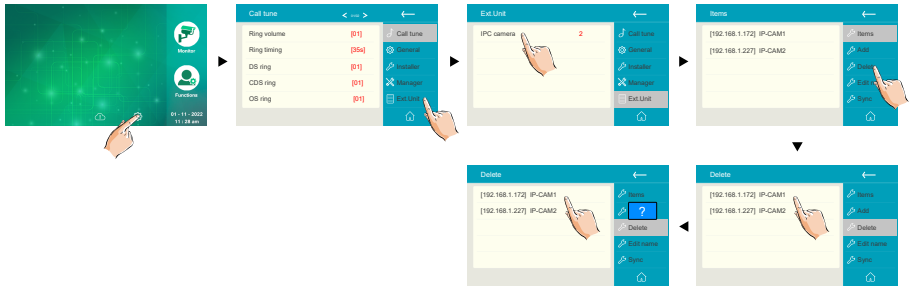

## Specification

- Power Source: Power-over-Ethernet (IEEE 802.3af Class 0)
- LAN Interface: 10 BASE-T / 100 BASE-TX Ethernet (RJ-45)
- Monitor screen: 7 Inch digital color TFT
- Display Resolutions: 800\*480 resolution
- Wire Type: Cat-5e or Cat-6
- Wiring Distance: 100m (Approx. 330')
- Operating temperature: -10 to +50 (oC)
- Dimension: 193(H)×235(W)×55(D)mm

