

2-wire Intercom System

CONTENTS

INTRODUCTION..... 2

 Installation Guide.....2

CONFIGURATIONS..... 4

 Debug State.4

 Work Mode..... 8

 Software Update.....10

 Tone Update.10

 UI Update.11

 Namelist Update. 12

 by SD Card..... 12

 by DT-Config..... 13



INTRODUCTIONS

Installation Guide

DESCRIPTION

As an upgrade of DPC-D218ID, DPC-D218ID-S has more stable and stronger ability of communication. It achieves call model of 128 families, expands capacity of the system. It also adds many special functions such as select by touching keypad, namelist, voice prompt, etc., which brings clients fresh and modernized experience. And for convenience, users can upgrade UI and Voice through SD card by themselves.

PARTS AND FUNCTIONS

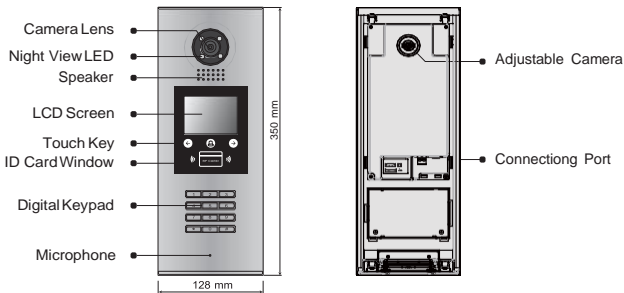

TERMINAL DESCRIPTION

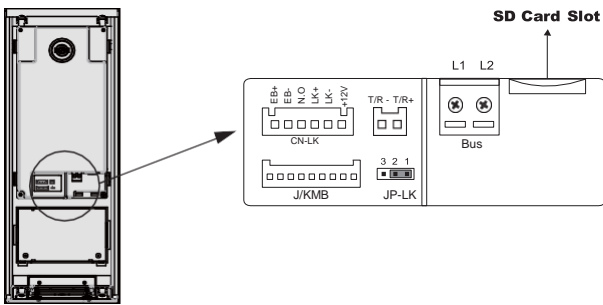

- **+12V:** 12VDC power output.
- **LK-(GND):** Power ground.
- **LK+(COM):** Common contact of the relay.
- **NO.:** Normally open contact of the relay (refer to DT technical guide for detail informations about lock connection).
- **EB+:** Exit button connection port.
- **EB-:** Exit button connection port.
- **JP-LK:** For electronic lock safety type setting (refer to door station lock connections).
- **T/R-:** USB-RS485 communication terminal negative.
- **T/R+:** USB-RS485 communication terminal positive.
- **Bus(L1,L2):** non-polarity bus line.

MOUNTING

Surface mounting

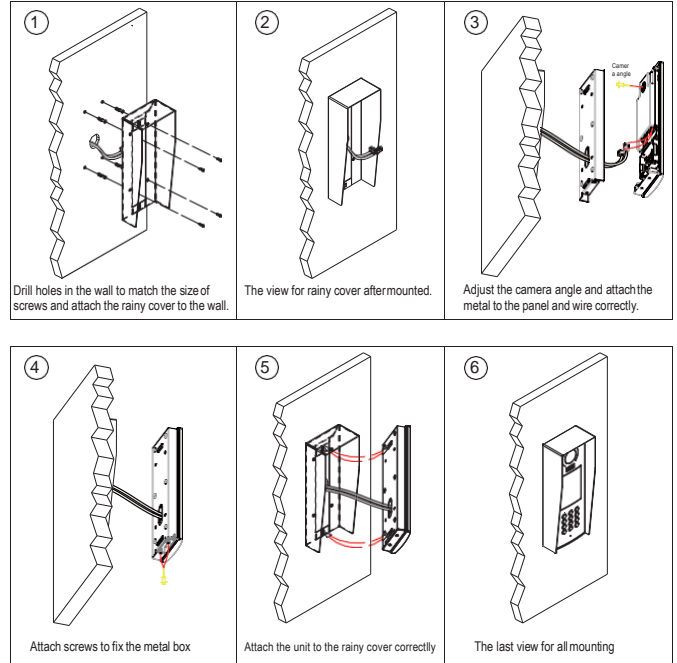

Flush mounting

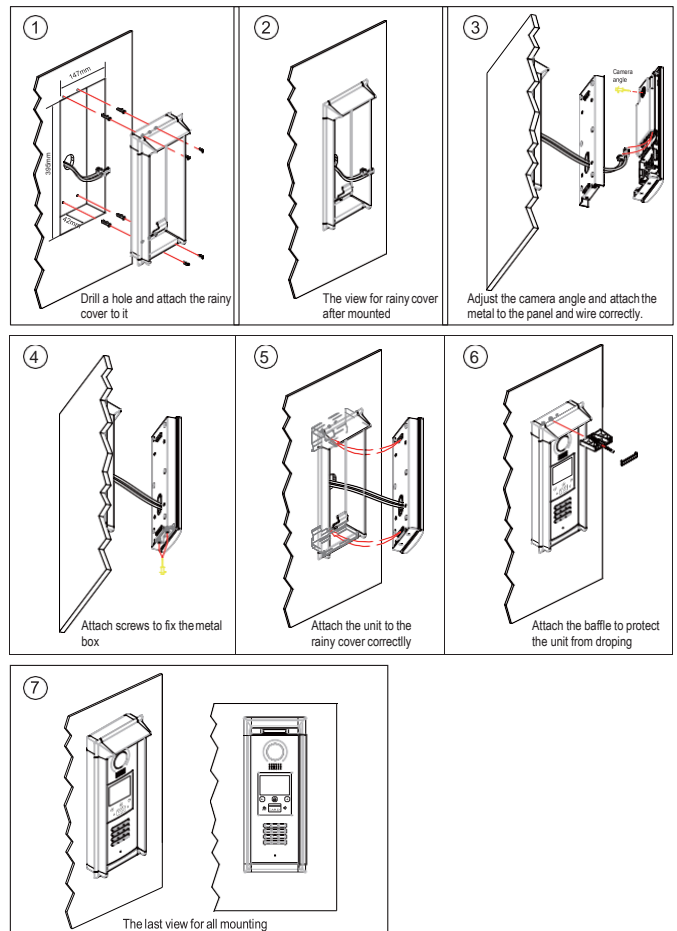

INTRODUCTIONS

Installation Guide

SYSTEM CONNECTION

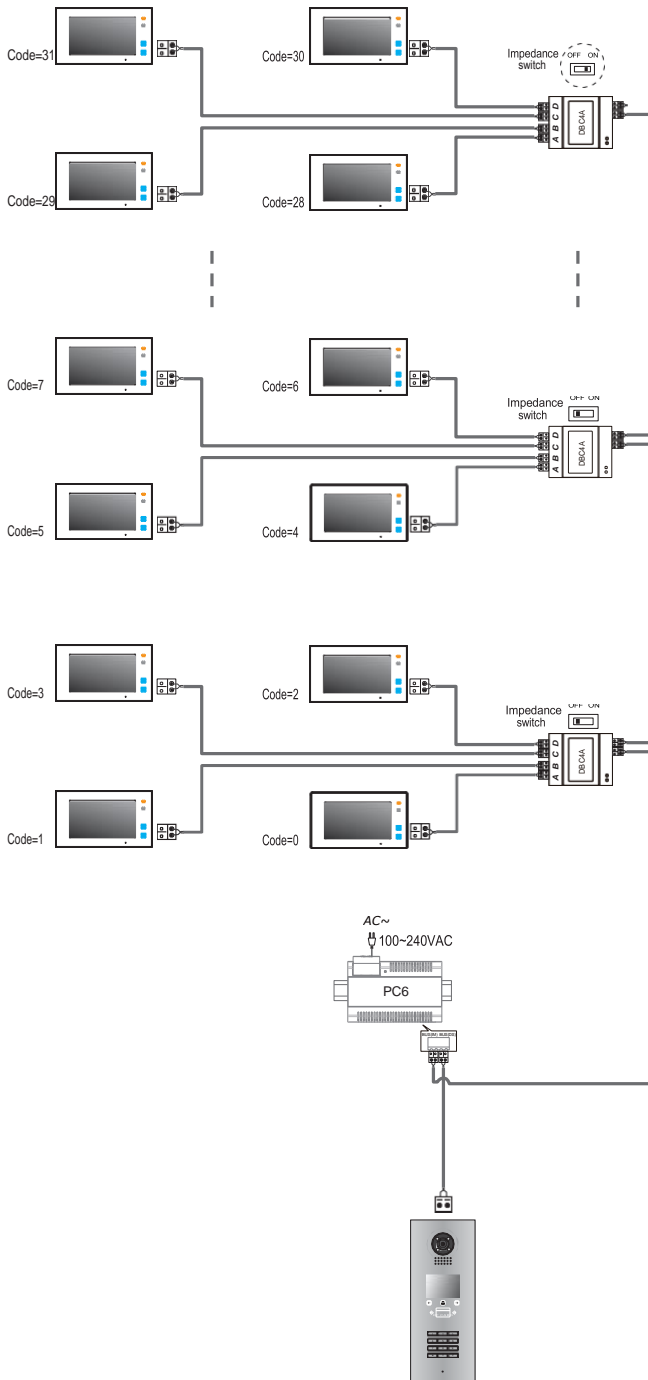

• Note: The diagram take the monitor of DT47M for example.

ELECTRIC LOCK CONNECTION

1) Door Lock Controlled with Internal Power

1. The door lock is limited to 12Vdc, and holding current must be less than 250mA when using internal power supply mode.
2. The Unlock Mode Parameter must be set to 0 (by default).
3. Jumper set to 1-2 position for power-off-to-unlock safety type(Normally closed mode); set to 2-3 position for power-on-to -unlock type(Normally open mode).
4. If different unlocking time is needed to be configured, change the unlock time on door station,detail information refer to DT system technical guide .

Power-on-to-Unlock type:

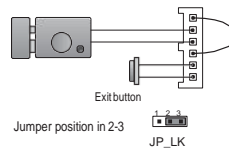

Power-off-to-Unlock type:

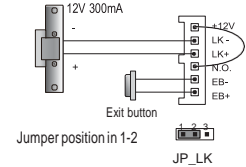

2) Door Lock Controlled with External Power

1. The external power supply must be used according to the lock.
2. The jumper must be taken off before connecting.
3. Setup the **Unlock Mode Parameter** for different lock types
 - Power-on-to-unlock type:Unlock Mode=0(by default)
 - Power-off-to-unlock type:Unlock Mode=1
4. If different unlocking time is needed to be configured, change the unlock time on door station,detail information refer to DT system technical guide .

Power-on-to-Unlock type:

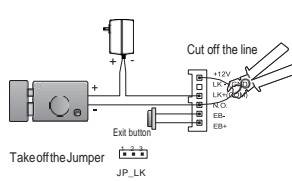

Power-off-to-Unlock type:

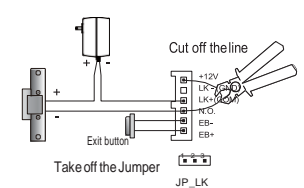

SPECIFICATION

- Power supply: DC24V
- Camera Lens: 1/4 ACS 4T image sensor
- Power consumption: Standby 33mA; Working status 157mA.
- Screen: 3.5 inch TFT
- Resolution: 320(R, G, B)X240 pixels
- Video signal: CCIR/EIA optional
- Wiring: 2 wires, non-polarity
- Dimension: 350(H)X128(W)X46(D)mm

CONFIGURATIONS

Debug State

DEBUG STATE

The Debug State is your starting point for using all the applications on DPC-D218ID-S.

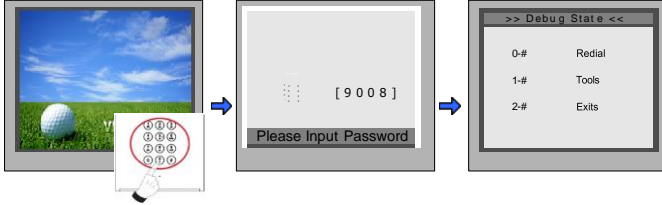

When door station is in standby, press '#' key
 Input '9008', then input the Admin Code.(66666666 by default)
 Debug state menu is launched

Descriptions:

- 0-#: Call Monitor again
- 1-#: Go to Tools setting item
- 2-#: Exit out Debug State

TALK VOLUME ADJUST

In **Debug State**, calling the monitor and conversation are available, you can input 0~9 to select the volume you want, see the following picture shows.



INSTALLER SETUP



During working at debug state,press "1#" to enter tools page.
 Press NO."1#" to enter Installer setup item.
 Installer setup page overview.

Descriptions:

1.ID Code: Select item 1 to enter **ID Code** setting page. You can input 0~3 to set as door 1 ~ door 4.

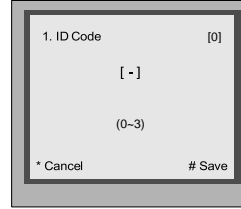

2.Unlock Timing: Select item 2 to enter **Unlock Timing** setting page, setting range is from 01~99s.

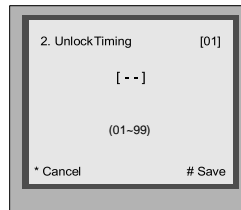

3.Unlock Output: Select item 3 to enter **Unlock Output** setting page.

0 : Power-on-to-unlock mode

1 : Power-off-to-unlock mode

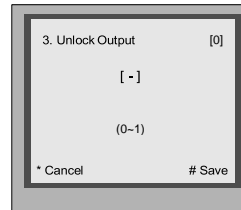

4. Monitor Timing: Select item 4 to enter **Monitor Timing** setting page .the setting range is from 006~600s.

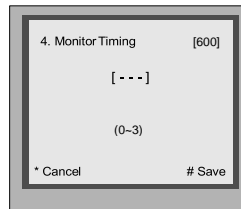

5.Doorplate Mode: Select item 5 to enter **Doorplate Mode** setting page.

0 : Input room number to call monitor

1 : Input room number + '#' to call monitor

* Note:

1) the diagram take "0" mode for example.

2) Disable input 1 digit number to call

CONFIGURATIONS

Debug State

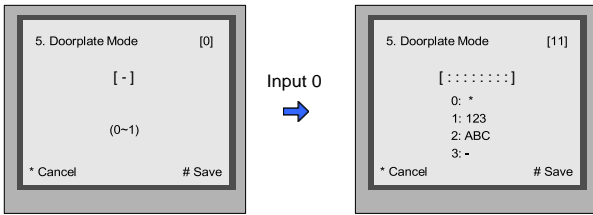

Input 0 →

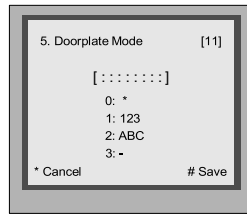

Set 2 digit number calling ↓

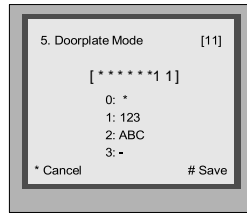

6.Waiting Timing: Select item 6 to enter **Waiting Timing** setting page.The setting range is from 006~600s.

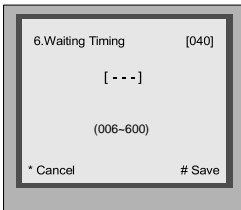

7. Talking Timing: Select item 7 to enter **Talking Timing** setting page.
The setting range is from 006~600s.

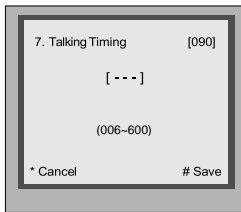

8. Installer Code: Select item 8 to enter **Installer Code** setting page. (Setting 8 digit numbers).

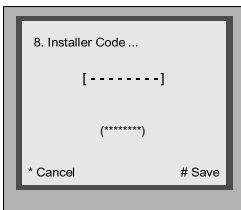

9.Default: Select item 9 to enter **Default** setting page. Input the setup code to restore factory setting.

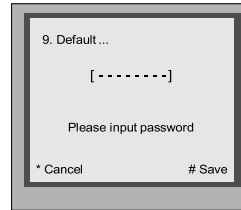

SETUP

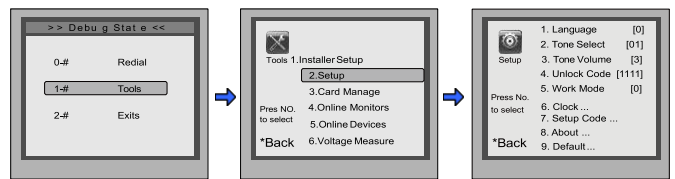

During working at debug state,press "1#" to enter tools page. Press NO."2" to enter Setup item. Setup page overview.

Descriptions:

1.Language: Select item 1 to enter **Language** setting page. Select the language you need.(Refer to the following **UI Update** section).

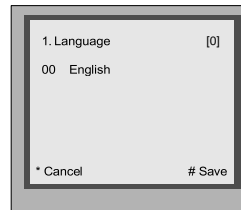

2.Tone Select: Select item 2 to enter **Tone Select** setting page. Select the Tone you want. (Refer to the following **Tone Update** section).

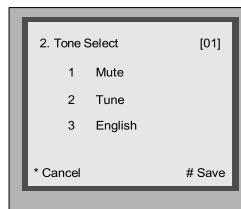

3.Tone Volume: Select item 3 to enter **Tone Volume** setting page. The setting range is 0 ~ 9.

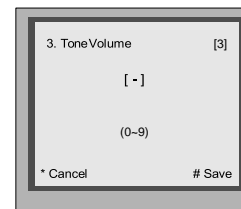

CONFIGURATIONS

Debug State

4.Unlock Code: Select item 4 to enter **Unlock Code** setting page. 1111 is the default unlock code. Input 4 digit numbers to set a new code(Except for 8001~8019 and 9008).

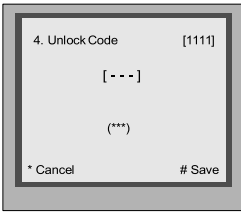

5.Work Mode: Select item 5 to enter **Work Mode** setting page. four modes can be available,the setting range is 0~3.(More details refer to the following **Work Mode** section)

- 0 : 32 apartments
- 1 : 128 apartments
- 2 : Router
- 3: Gateway

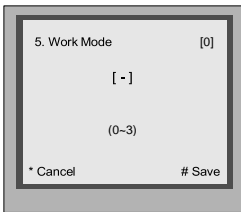

6.Clock: Select item 6 to enter **Clock** setting page.

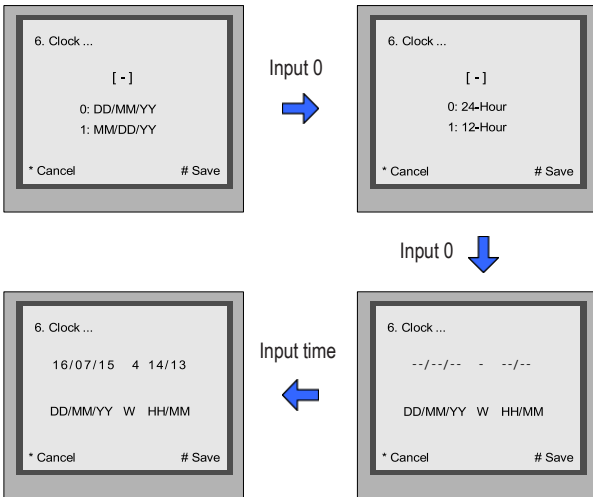

* Note: the diagram take "0" mode for example.

7.Setup Code: Select item 7 to enter **Setup Code** setting page. Input 8 digit numbers to set a new setup code, then press '#' to save.

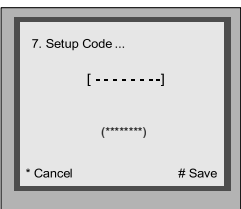

8.About: Select item 8 to enter **About** page. The information includes Hardware version, Software Version etc.

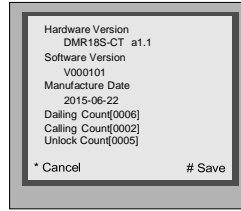

9.Default: Select item 9 to enter **Default** setting page. Input setup code to restore factory settings.

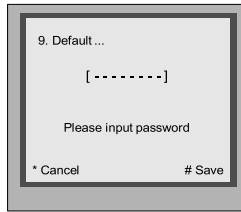

CARD MANAGE

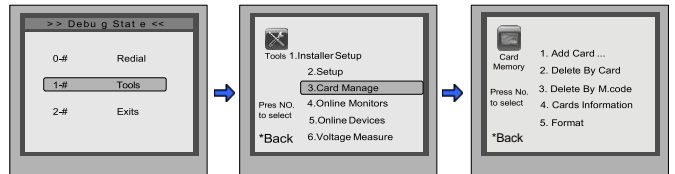

During working at debug state,press "1#" to enter tools page. Press NO."3" to enter Card Manage page. Card Manage page overview.

1.Add Card: Select item 1 to enter **Add Card** setting page.

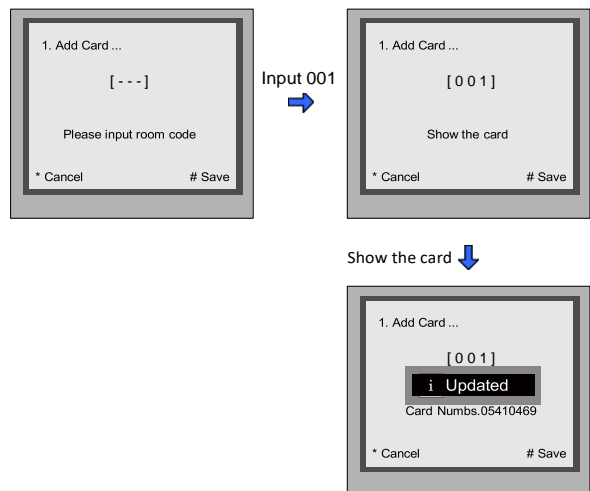

CONFIGURATIONS

Debug State

2.Delete Card:

- Select item 2 to Delete By Card.

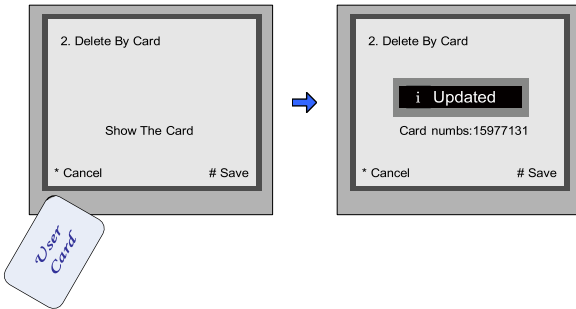

- Select item 3 to Delete By M.code.

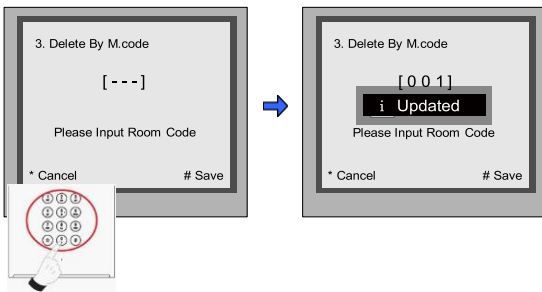

3. Card Information:

Select item 4 to enter **Card Information** page,the card count will be showed.

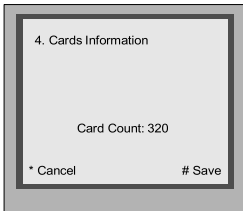

4. Format:

Select item 5 to enter **Format** page.Input 8 digits password to start format.

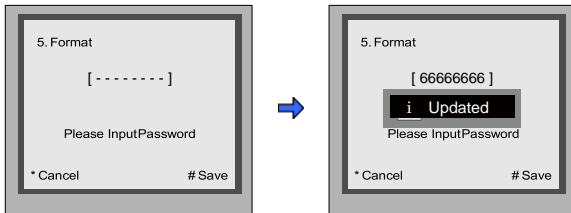

ONLINE MONITORS

To search the Gateway and Online Monitors,input the monitor code number to search.



During working at debug state,press "1#" to enter tools page.

Press NO."4" to enter Online Monitors item.

Input the search range,then press "#" to start search.

ONLINE DEVICES

To search the online door stations(Max.4 door station can be searched) and the other accessories.



During working at debug state,press "1#" to enter tools page.

Press NO."5" to enter Online Devices item.

All devices online or offline will be showed.

VOLTAGE MEASURE

To check the voltage of the monitor,note that the monitor must be online.



During working at debug state,press "1#" to enter tools page.

Press NO."6" to enter Card Manage item.

Input the code,then press "#" to search.

CONFIGURATIONS

Work Mode

DEFINITION

Total four different work modes are available for DPC-D218ID-S to accommodate different situations. In standby mode, input #8002 + code (66666666) and select "5" item to enter **Work Mode** setting page.

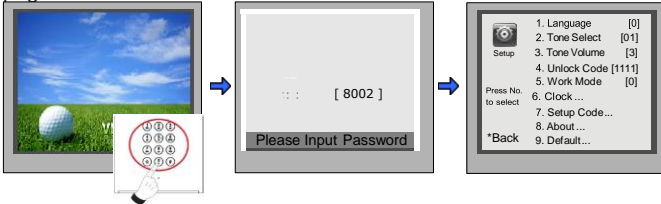

When door station is in standby, press '#' key
 Input '8002', then input the Admin Code.(66666666 by default)
 Select "5" to enter Work Mode page.

STANDARD 32APARTMENTS

Work Mode set to 0;

The **Standard Mode** is applied in a small capacity system, which monitors are under 32 and without BDU unit. Generally dial 01~32 to call the monitor.

Work Mode set to **0**, and ID code set to **0~3**.

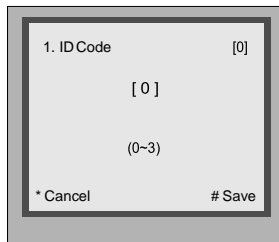
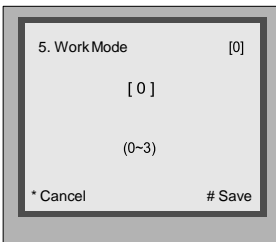

Input Mode: In standby mode. Input #8001+ Code(66666666 by default), then select "5" item to set the **Doorplate Mode**, for example input the code 15 to call the monitor.

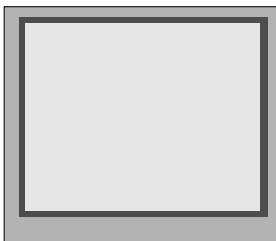

DT-DJ MODE

Work Mode set to 1:

The **DT-DJ Mode** is used for the audio intercom system. When the system contains the audio monitors, such as DJ4A, DJ5A, DJ6A, etc. The **DT-DJ Mode** can be assigned the address from 001 to 128 without BDU unit.

Work Mode set to **1**, and ID code set to **0~3**.

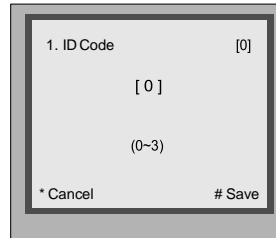
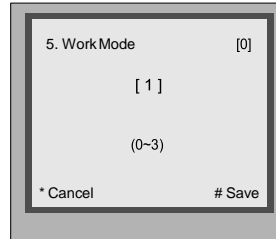

Input Mode: In standby mode. Input #8001+ Code (66666666 by default), then select "5" item to set the **Doorplate Mode**, for example input the code 068 to call the monitor.

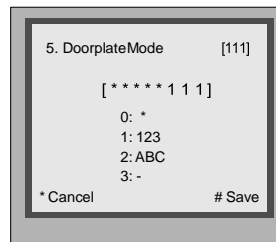

CONFIGURATIONS

Work Mode

DT-BDU ROUTER MODE

The **Router Mode** is used for the big capacity system which has plenty of apartments for blocks with BDU unit. The namelist can be updated by SD Card or DT-Config (More details refer to **Update Namelist Section**).

Work Mode Set to **2**, and ID code set to **0~3**.

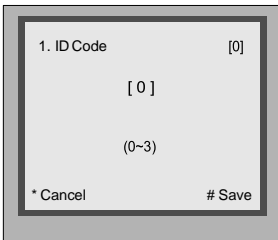

Input Mode: In standby mode. Input #8001+ Code (66666666 by default), then select " 5 " item to set the **Doorplate Mode**, for example input 13-02 to call the monitor. As the following picture shows: 13 means the 13th floor, and 02 means the second room number.

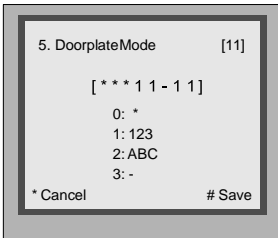

DT-BDU GATEWAY MODE

The **Gateway Mode** is used for the community network system, the common door station is connected in the system which can call all the monitors. Besides, if the door station is connected in each block, it can call the monitors in the block.

Work Mode set to **3**, and ID code set to **0~3**.

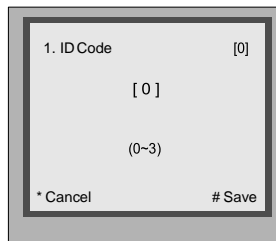

Input Mode: In standby mode. Input #8001+ Code (66666666 by default), then select " 5 " item to set the **Doorplate Mode**, for example input 3-06 to call the monitor. As the following picture shows: 3 means the third BDU, and 06 means the ID code of monitor is 06.

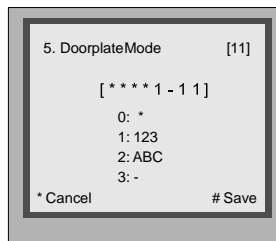

CONFIGURATIONS

System Update

DESCRIPTIONS

This section is used for the software version V000101 of DPC-D218ID-S. (After 2015.07.10); In standby mode, please input “##” to check the DPC-D218ID-S software version, see the following picture shows:



How to enter update page:

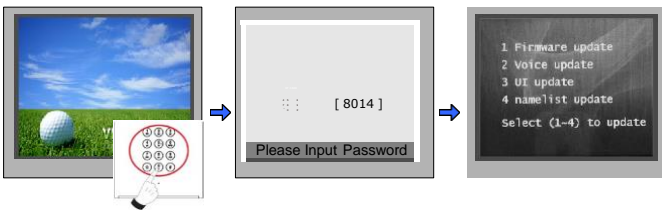

When door station is in standby, press # key Input '8014', then input the Code 87625761 Update setting page overview

SOFTWARE UPDATE

1. Format SD card
2. Copy the update software file(DPC-D218ID-S.bin,provided by our company) to SD card by computer.



4. Select 1 to enter **Firmware update**, the information of “update ready” will be showed.



5. Insert the SD card to slot, the information of “Download...” will be showed when the updated is in progress. After 3 seconds, a long sound “BP+” will be heard to start the updated.

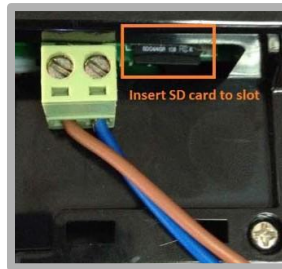

6. When update is finished, it will return to **Standby Mode** interface.

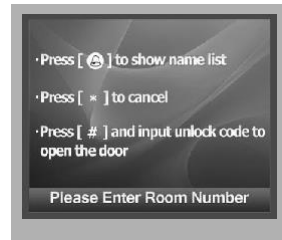

TONE UPDATE

1. Format SD card
2. About the Ringtone file
 - English is the standard audio file, as the picture shows:

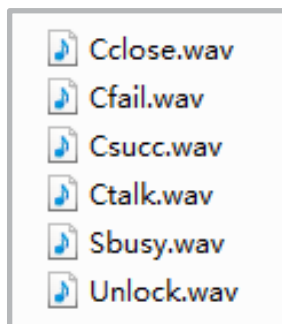

CONFIGURATIONS

System Update

- If other languages are needed for you, please record the audio file which language you want.

- Then provide the audio file to our company, a Ring.bin file will be created for you to update the tone.

3. Copy the Ring.bin file to SD card by computer.



4. Select 2 (Voice update) to enter **Tone update**, the information of "update ready" will be showed.



5. Insert the SD card to slot, the information of "Download..." will be showed when the updated is in progress. After 3 seconds, a long sound "BP+" will be heard to start the updated.



6. When update is finished, it will return to **Standby Mode** interface.



7. Check the Tone

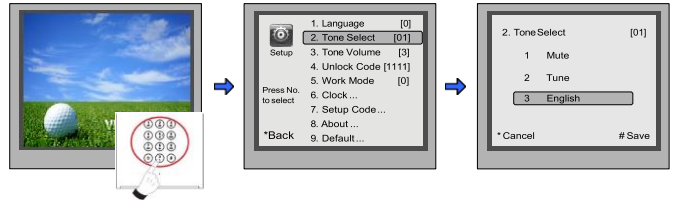

When door station is in standby, press '#8002'+code 66666666 to enter **Setup** page.

select item 2 to enter **Tone Select** setting page.

Select 02(English) to check your tone update, and press # to save.

UI UPDATE

1. Format SD card

2. Edit UI file

Multi languages are supported on DPC-D218ID-S, English is the standard language, if other languages are needed for you, please provide the translation to us. About the UI file, see the following picture shows:

English	Language
Press [*] to show name list	
Press [*] to cancel	
Press [#] and input unlock code to open the door	
Please Enter Room Number	
>> Name List Call <<	
Press [*] to call	
Please input Password	
Updated	
Door Open	
Door Open	
Cancel	
System Busy	
Ignore Change	
Download...	
Invalid Code	
Invalid Card	
Password Error	
Link Error	
Error	
Calling...	
* Cancel	
# Redial	
Conversation	

CONFIGURATIONS

System Update

3. Copy the Update UI file to SD card by computer.

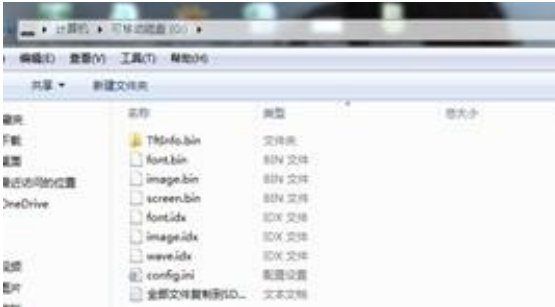

4. Select 3 to enter **UI update**, the information of "update ready" will be showed.

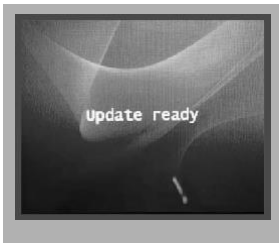

5. Insert SD card to slot, after that, the update progress will be showed.



6. When update is finished, it will return to **Standby Mode** interface. And show the new UI.

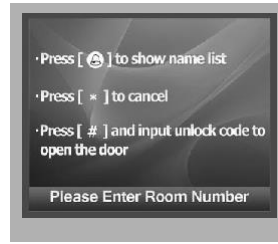

NAMELIST UPDATE

1) Namelist update by SD card

1. Format SD card
2. Namelist.txt file setting

- Create a TXT file, and named NameList.

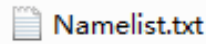

- Open the NameList.txt file, and input 5 [] symbols. Each [] symbol has its meaning, see the following picture.



Descriptions:

Input: Input the number to call the monitor

Name: It would be displayed on screen

Gateway: Set the gateway mode recording to BDU address. [08~15] means BDU address 01~08

Router: Set the Router mode recording to BDU address. [01~08] means BDU address 01~08

Address: Set the monitor address you want to call

- Edit NameList.txt file, for example, as the following picture shows:

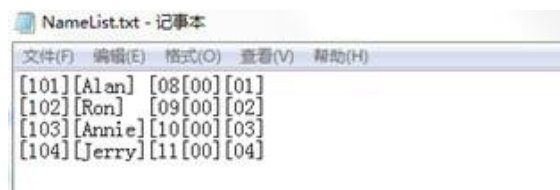

Input 101 or 1-01, it would call the monitor 01 in BDU 1.

CONFIGURATIONS

System Update

3. Copy the Namelist file to SD card by computer.



4. Select 4 to enter **Namelist update**, the information of “update ready” will be showed.



5. Insert the SD card to slot, the information of “Download...” will be showed when the updated is in progress. After 3 seconds, a long sound “BP+” will be heard to start the updated.



6. When update is finished, it will return to **Standby Mode** interface.



7. Press touch button to show the Name list



2) Namelist update by DT-Config

DPC-D218ID-S-Config software is for parameters setting, namelist setting etc. It is great convenience to installation.

The DPC-D218ID-S-Config software operation is as follows:

1. Open “DPC-D218ID-S-Config” software, connect DPC-D218ID-S to PC via USB-RS-485; Click “Setting” on the menu bar then click Com to select right Com. (Com information can be found in “My Computer -> Properties -> Device Manager -> Ports”)

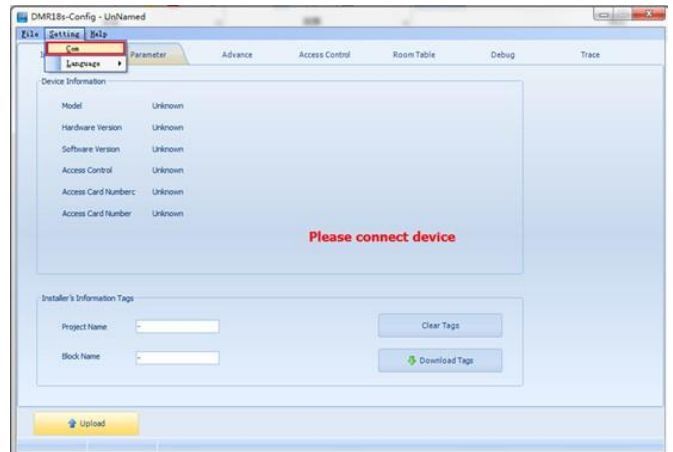

2. Then if DPC-D218ID-S is connected to PC successfully, one tips of “Device connected” will be showed. Click “Room Table” tab to edit Name list.)

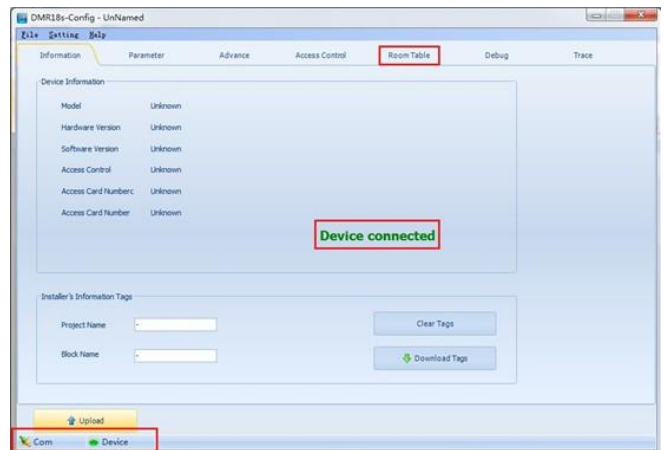

3. Then click “Insert” to create the first item.

Each item have 5 different properties:

Address: Monitor's address (can be find in “about”);

User Code: The number you can dial to the monitor;

Name: The name of resident;

Router: Set the BDU address when it is in Router mode;

Gateway: Set the BDU address when it is in Gateway Mode.

CONFIGURATIONS

System Update

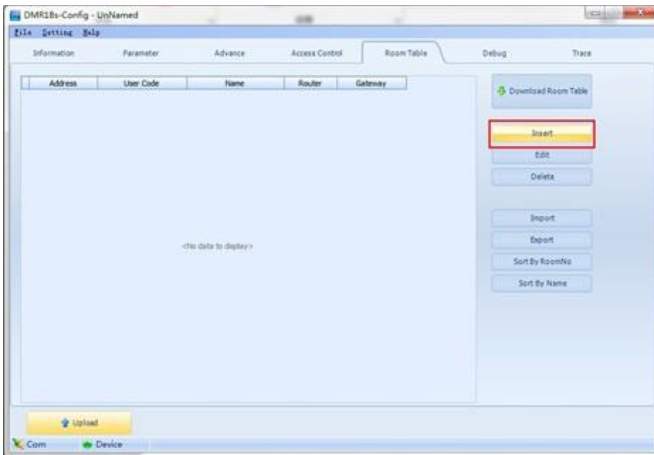

4. Edit Namelist

4.1 Apartments

- For example: Dial 101 to call the Apartment 01 without BDU. See the following picture shows:

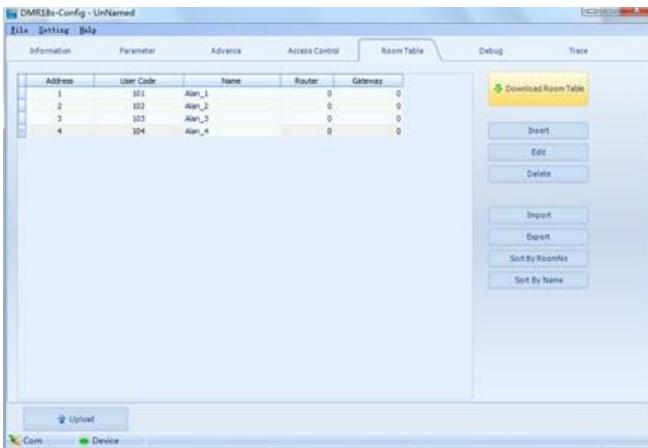

- After edited, click "Download Table" to download Name List to DPC-D218ID-S; After a few seconds, a window will be displayed if it is updated successfully.

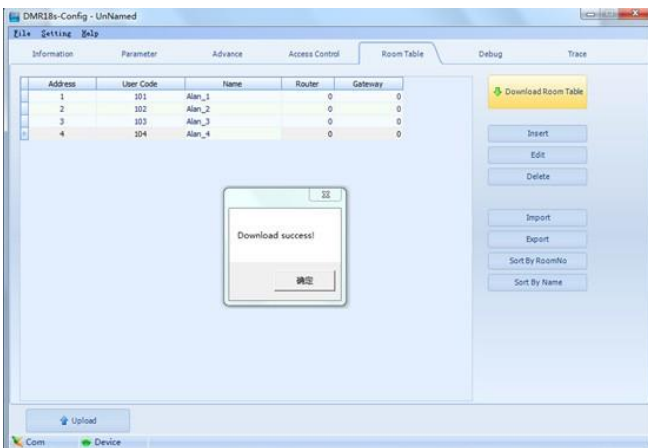

- Check Name List on DPC-D218ID-S

Set the DPC-D218ID-S **Work Mode** as 0 (more details refer to **Work Mode** setting section).

- Press touch button to enter **Name List** page. See the following picture shows.

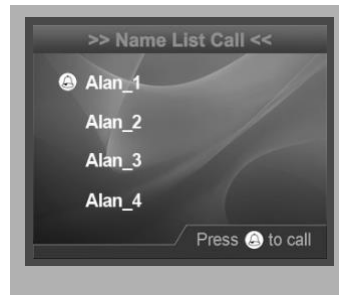

4.2 Router

- Input 01-01 to call the monitor 01 in the BDU 1 when it is in **Router mode**, And input 02-02 to call the monitor 02 in the BDU 2 when it is in **Router mode**, see the following picture:

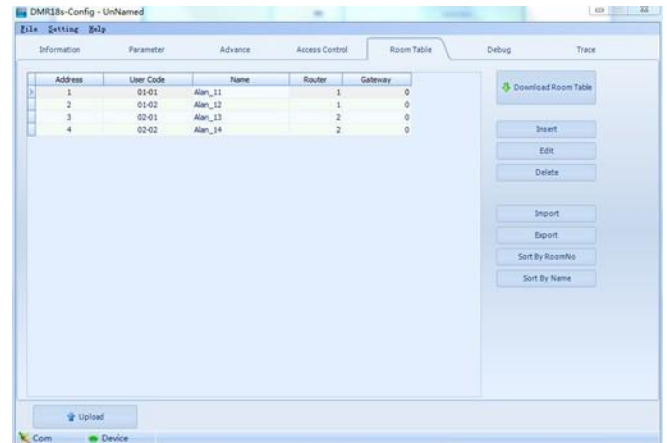

- Click Download Room Table to download the namelist.

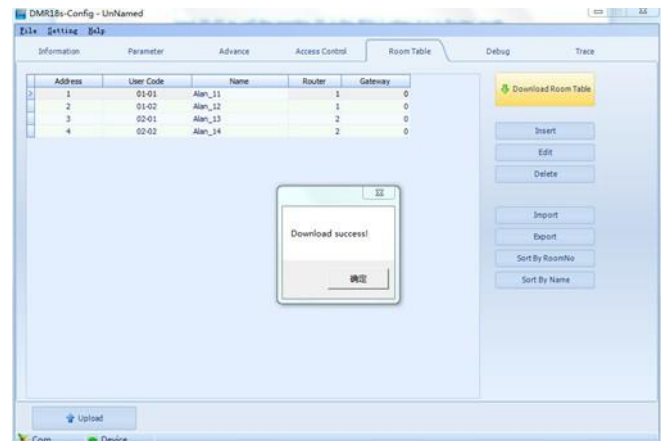

CONFIGURATIONS

System Update

- Check Name List on DPC-D218ID-S

Set the DPC-D218ID-S **Work Mode** as 2 (more details refer to **Work Mode** setting section).

- Press  touch button to enter **Name List** page. See the following picture shows.

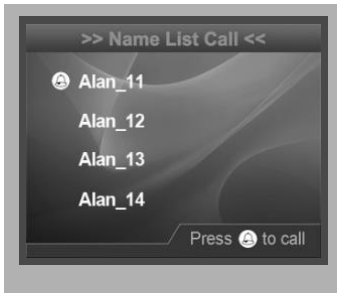

- Check Name List on DPC-D218ID-S

Set the DPC-D218ID-S **Work Mode** as 3 (more details refer to **Work Mode** setting section).

- Press  touch button to enter **Name List** page. See the following picture shows.

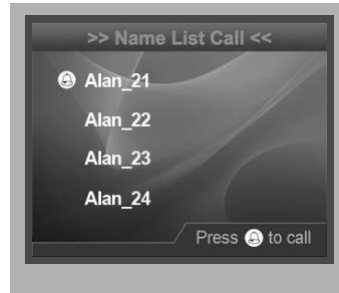

4.3 Gateway

- Input 1-01 to call the monitor 01 in the BDU 1 when it is in **Gateway** mode, And input 2-02 to call the monitor 02 in the BDU 2 when it is in **Gateway mode**, see the following picture:

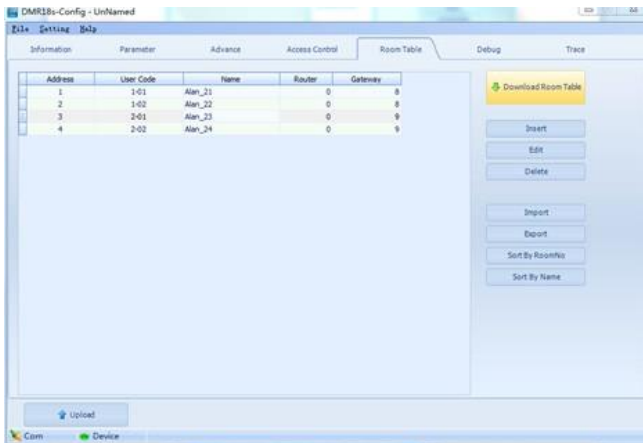

- Click Download Room Table to download the namelist.

