

# Internet Telephony PBX System

## IPX-330



[www.planet.com.tw](http://www.planet.com.tw)

Copyright © PLANET Technology Corporation. All rights reserved.

# Presentation Outlines

- ◆ **Product Overview**
- ◆ **Product Features**
- ◆ **Applications**
- ◆ **Product Comparison**



# Voice Over IP- IP PBX



## ◆ The PLANET IP PBX Family

- Ongoing
- Planning
- New Phase in

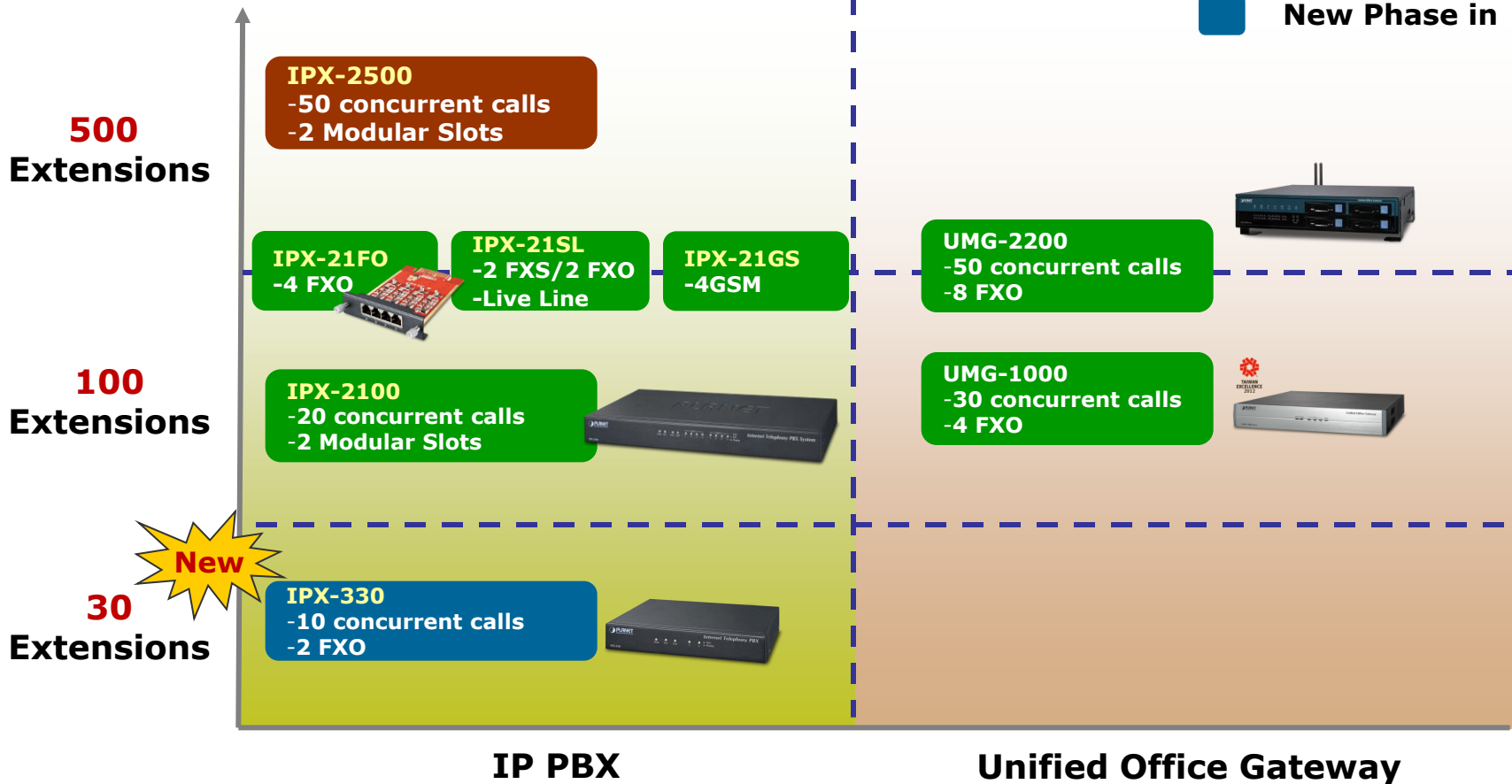

# Product Overview

## Front Panel of IPX-330

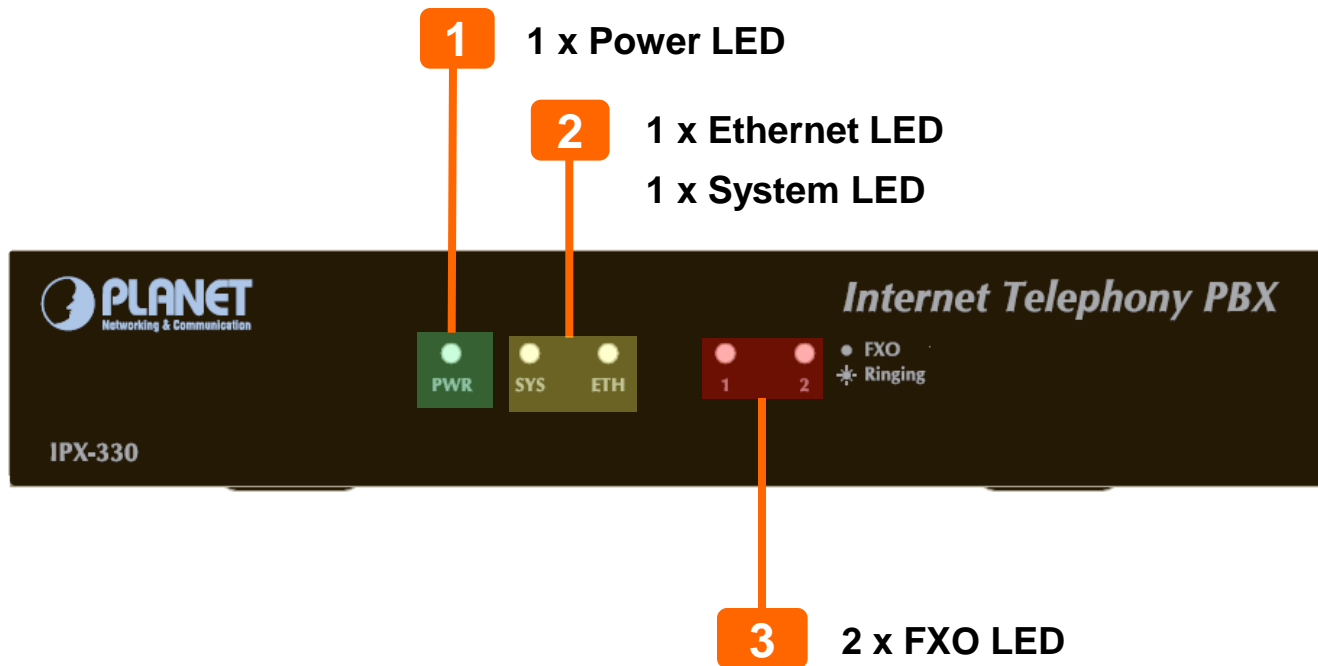

# Product Overview

## Rear Panel of IPX-330

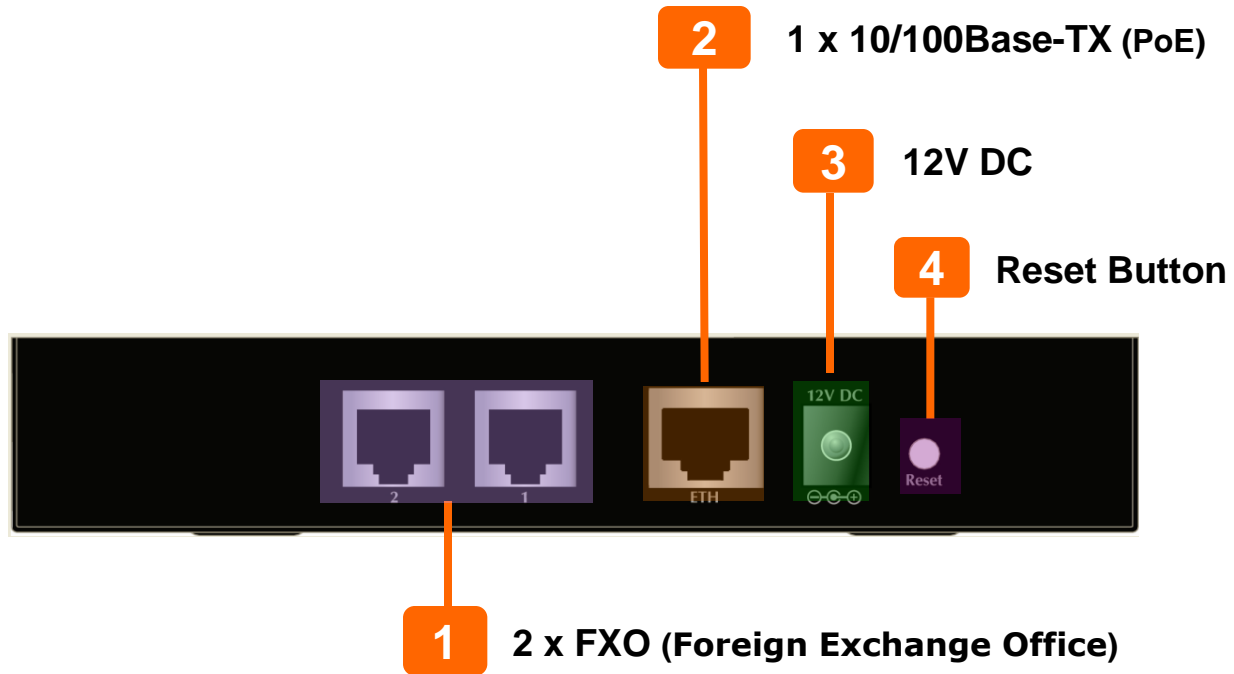

# Product Installation

## Physical Connection

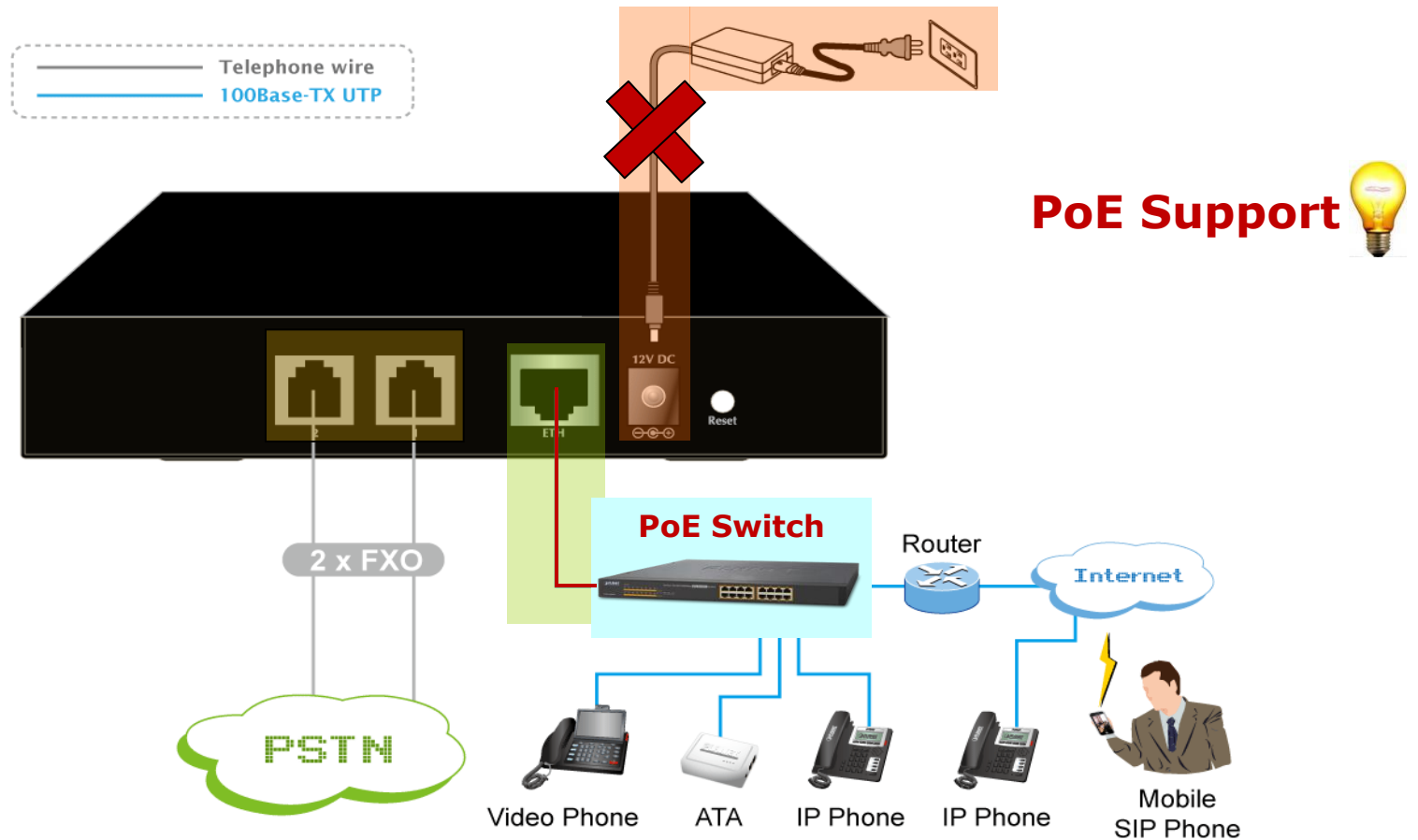

# Product Overview

## ◆ Dimensions

- ✓ **155 × 295 × 65 mm (W x D x H)**

## ◆ Weight

- ✓ **0.5 KG (without package)**

## ◆ Environmental Specifications

- ✓ **Operating Temperature & Humidity:**

- **-10°C ~ 45 degrees C / 10~80% humidity**

- ✓ **Storage Temperature & Humidity:**

- **-30 ~ 65 degrees C / 10~80% humidity (non-condensing)**

## ◆ Power Consumption

- ✓ **12VDC / 1A or IEEE802.3af PoE**

# Product Features

## ✓ PBX Features

- **10** concurrent calls/up to **30** registers
- **HD** voice codec **G.722** for perfect voice quality
- **Fax to Email / Email to Fax** for virtual fax
- **BLF** (Busy Lamp Field)
- **DID** (Direct Inward Dialing Number)
- Interactive Voice Responses (**IVR**)
- Voice mail to Email
- **DISA** (Direct Inward System Access)
- **Built-in SIP/IAX2 Server**
- IPv4 / **IPv6**
- **VPN Client / VPN Server**
- Supports maximum **2-port** FXO





# Product Features

## ✓ VoIP Features

- **SIP** 2.0 (RFC3261) compliant
- **Asterisk (v1.8)** Compatible IP PBX
- User-friendly Web configuration and Wizard Setting
- Voice codec: **G.722**, G.711-Ulaw, G.711-Alaw, G.726, G.729, GSM, SPEEX
- Video codec: H.261, H.263, H.263+, H.264
- **T.38 Fax** transmission over IP network (G.711 Fax pass-through)



## ✓ Call Features

- **Caller ID** Display
- Call Pickup / Call Park / Conference Room
- **Customization Music** on Hold / Music on Transfer
- Call Forward (Always / Busy / No answer) Internal / **External Call Forward**
- Call Transfer / Call Hold / Call Waiting / DND
- **Call Paging / Intercom**
- **Call Monitoring**

# Product Features



## ✓ Other Features

- Supports **Skybe for SIP**
- **IEEE 802.3af PoE** support
- **DDNS** Client (Supports PLANET Easy DDNS / PLANET DDNS / Dyndns.org / Zoneedit.com / NO-IP)
- Troubleshooting (Ping, Traceroute)
- **Auto Provision**
- **VPN Client** (Supports PPTP / L2TP / OpenVPN)
- **VPN Server** ( Supports PPTP / L2TP / OpenVPN Server)
- Black List
- Phone Book
- **SNMPv2**

## Product Features - *Video Communication*



## Product Features - *Paging / Intercom*

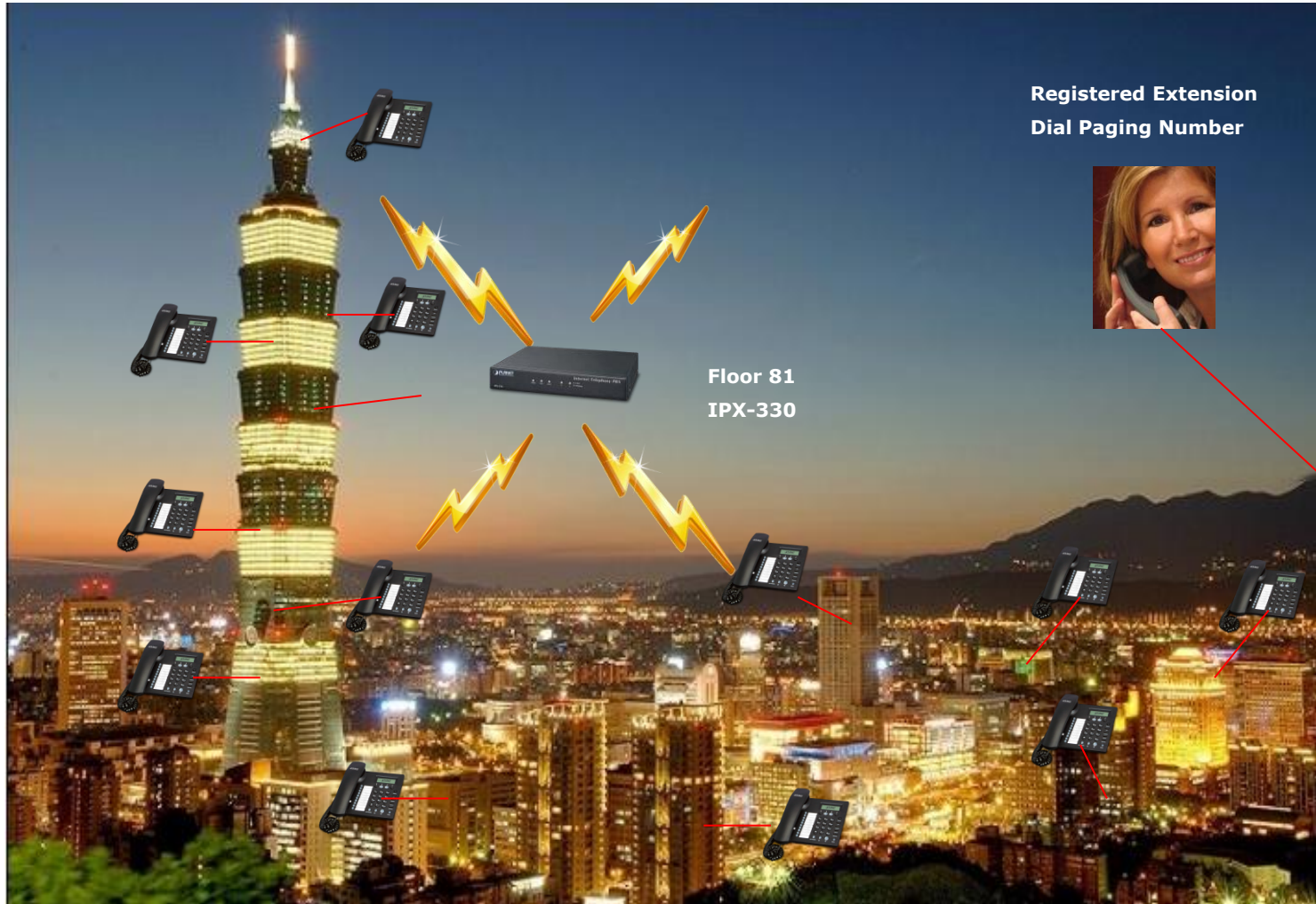

## Product Features - *Fax to Email / Email to Fax*

### Green Office

It's an easy and confidential way of receiving, storing and forwarding important fax documents, thus creating a paperless or green office.



*Green Office (Fax to Email / Email to Fax)*

## Product Features - *VPN Client / VPN Server*

### Full Security with VPN

The IPX-330 VPN securely and cost-effectively connects geographically disparate offices of an organization, creating one cohesive virtual network.

### Supports VPN Client and VPN Server

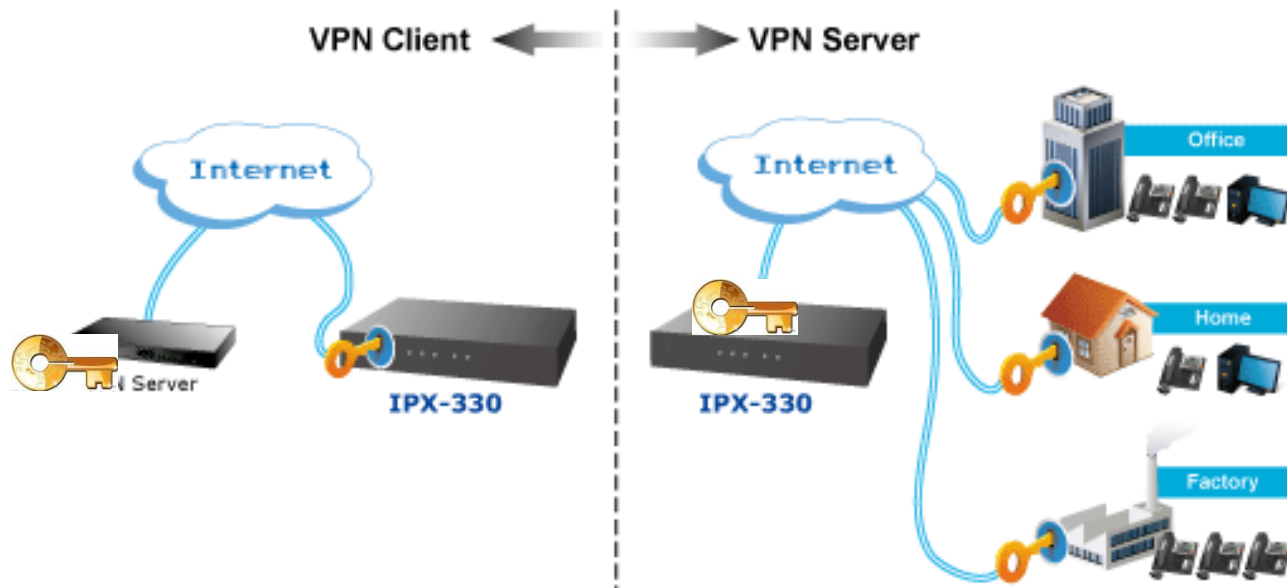

# Product Applications

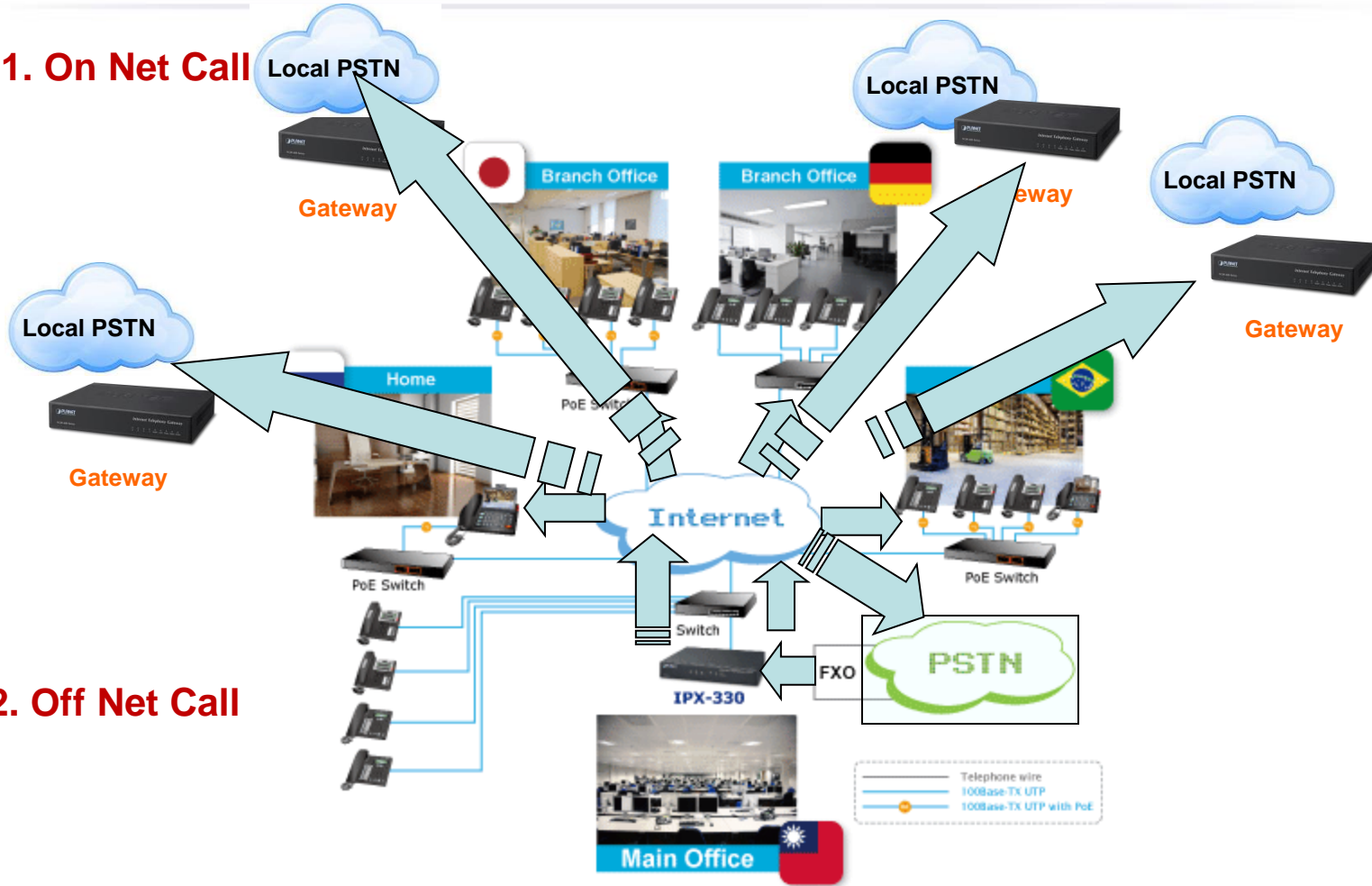

## 1. On Net Call



## 2. Off Net Call







# Product Comparison - Internal

Model	IPX-330	IPX-300
Features		
Asterisk Version	<b>V1.8</b>	<b>V1.4</b>
SIP (RFC3261) / IAX2	■	■ / -
Voice mail / Recording (GSM)	<b>21000 minutes</b>	-
HD Voice Codec (G.722)	■	-
IPv6	■	-
SNMPv2	■	-
VPN Server / VPN Client	■	-
PoE Support	■	-
Paging / Intercom	■	-
Fax to Email / Email to Fax	■	-
FXO Port	<b>2 FXO Ports</b>	-



# Appendix

## ◆ Related IP PBXs

Model Name		Description
<b>IPX-330</b>		Internet Telephony PBX System (30 Extensions, 2 x FXO)
<b>IPX-2100</b>		Internet Telephony PBX System (100 Extensions, 2 Modular Slots)
<b>IPX-2500</b>		Internet Telephony PBX System (500 Extensions, 2 Modular Slots)
<b>UMG-1000</b>		Desktop Unified Office Gateway (100 Extensions, 4 x FXO)
<b>UMG-2200</b>		Unified Office Gateway (250 Extensions, 8 x FXO)

# Sales Target

## ◆ Target Markets

- ✓ ISP / ITSP
- ✓ System Integrator
- ✓ Reseller



## ◆ Profitable Solutions

The following are potential to all customers:

- ✓ **IP PBX & UMG Solutions**
  - IPX-300, IPX-1980, UMG-1000, UMG-2200
- ✓ **IP Phone Solutions**
  - VIP-254NT, VIP- 256PT, VIP-362WT
  - VIP-2020PT, VIP-5060PT
- ✓ **ATA Solutions**
  - VIP-156, VIP-156PE
  - VIP-157, VIP-157S





# **ACTIVATING IP POWER**