

Internet Telephony PBX System

IPX-2100



www.planet.com.tw

Copyright © PLANET Technology Corporation. All rights reserved.

Presentation Outlines

- ◆ **Product Overview**
- ◆ **Product Features**
- ◆ **Application**
- ◆ **Product Comparison**



Voice Over IP- IP PBX



◆ The PLANET IP PBX Family

- Ongoing
- Planning
- New Phase in

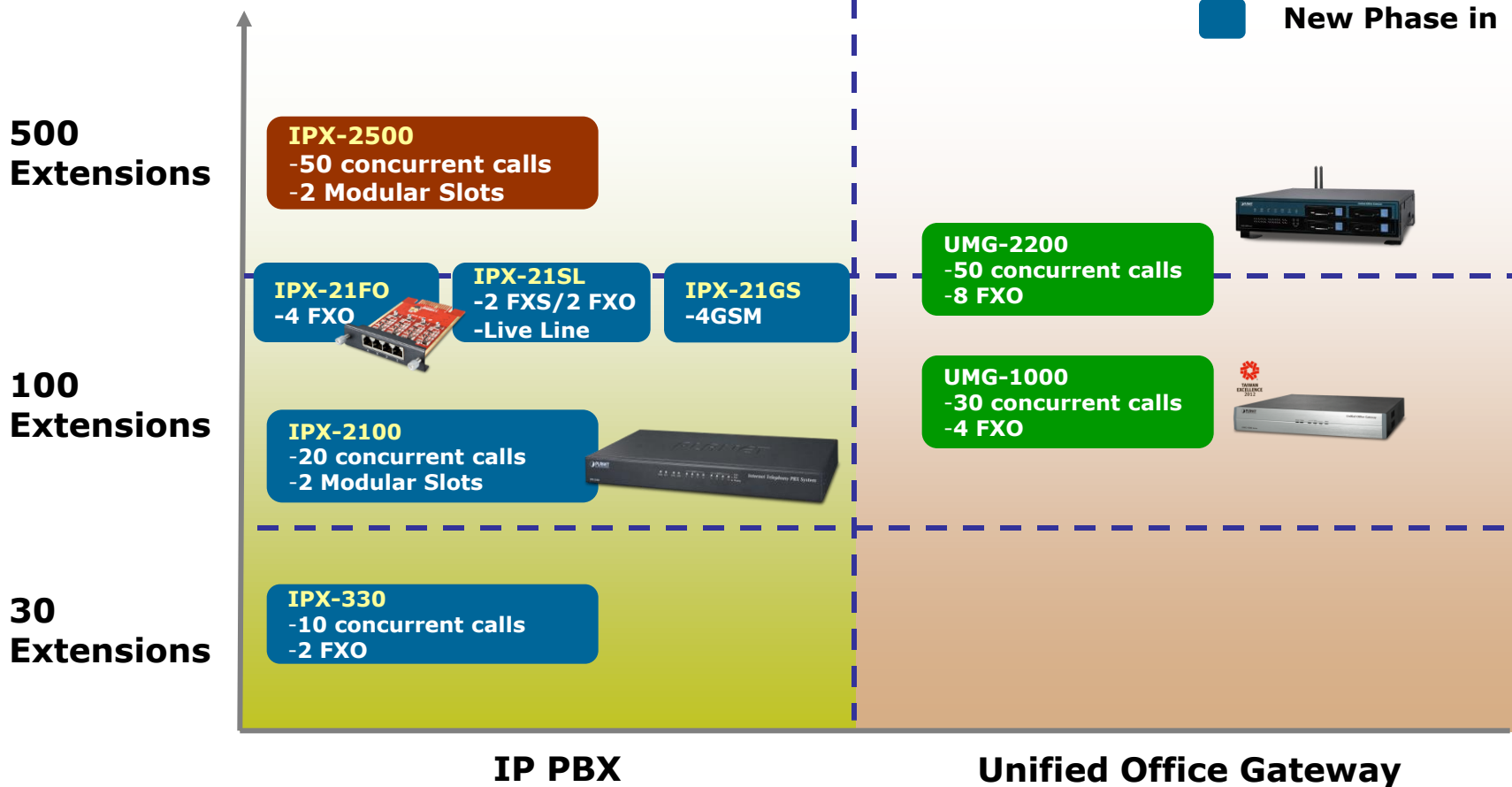

Product Overview

Front Panel of IPX-2100

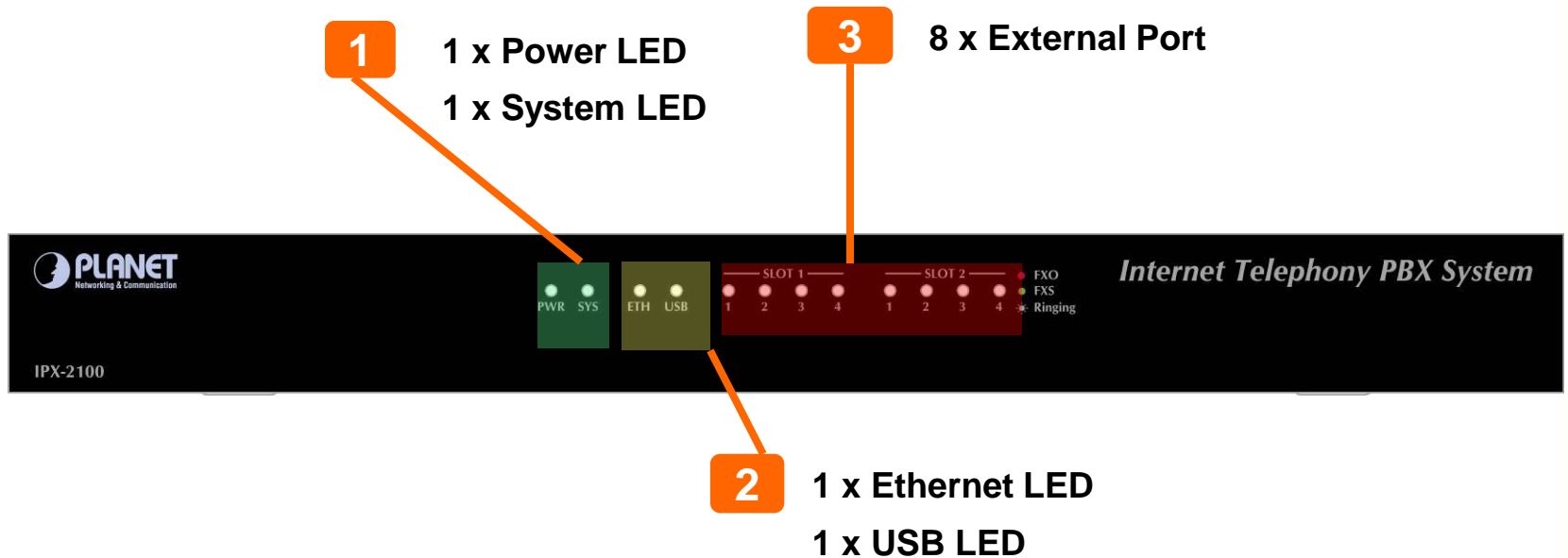

Product Overview

Rear Panel of IPX-2100

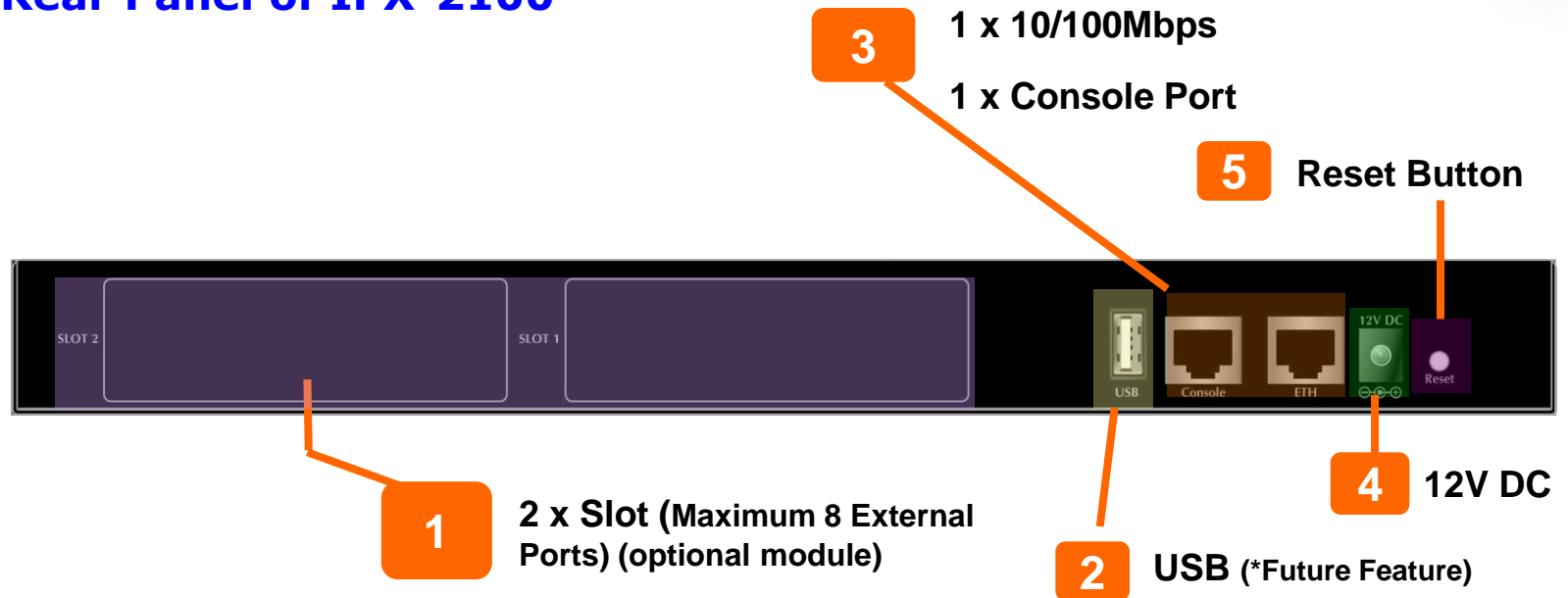

Product Installation

◆ Physical Connection

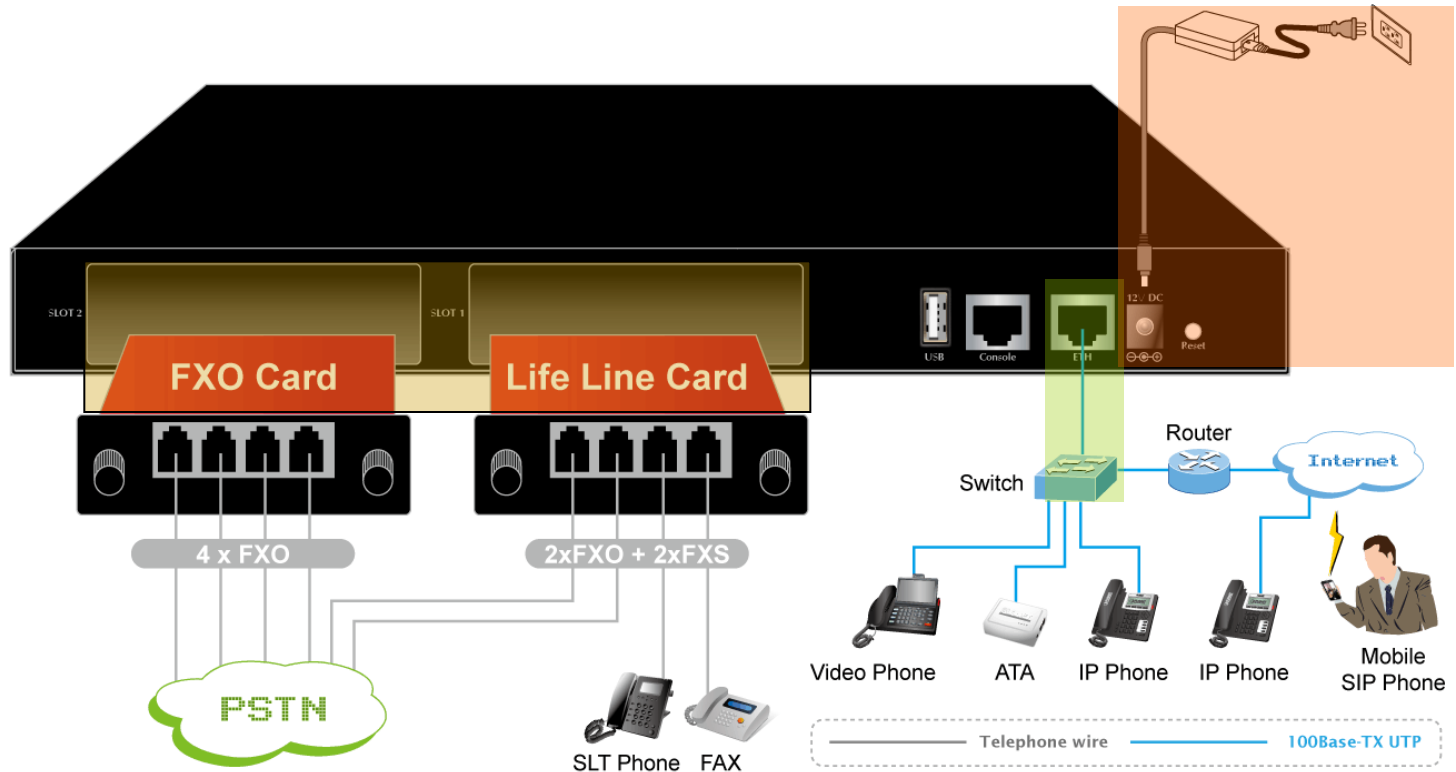

Product Overview

◆ Dimensions

- ✓ **343 x 154 x 35 mm (W x D x H)**

◆ Weight

- ✓ **1.4 KG (without package)**

◆ Environmental Spec.

- ✓ **Operating Temp & Humidity:**

- **-10 ~ 45 degrees C / 10~80% Humidity**

- ✓ **Storage Temp & Humidity:**

- **-30 ~ 65 degrees C / 10~80% Humidity (non-condensing)**

◆ Power Consumption

- ✓ **12V / 2A DC , AC 100~240V**

Product Features

✓ PBX Features

- **20 concurrent calls/ Up to 100 registers**
- **HD** voice codec **G.722** for perfect voice quality
- **Fax to Email / Email to Fax** for Virtual Fax
- **BLF** (Busy Lamp Field)
- **DID** (Direct Inward Dialing Number)
- Interactive Voice Responses (**IVR**)
- Voice mail to Email
- **DISA** (Direct Inward System Access)
- **Built-in SIP/IAX2 server**
- IPv4 / **IPv6**
- **VPN Client / VPN server**
- Supports maximum **8 ports** FXO / FXS / GSM (optional module)

Product Features

✓ VoIP Features

- **SIP** 2.0 (RFC3261) compliant
- **Asterisk (1.8)** Compatible IP PBX
- User Friendly Web configuration and Wizard Setting
- Voice codec: **G.722**/ G.711-Ulaw/ G.711-Alaw/ G.726/ G.729/ GSM/ SPEEX
- Video codec: H.261,H.263,H.263+,H.264
- **T.38 Fax** transmission over IP network (G.711 Fax pass-through)



✓ Call Features

- **Caller ID** Display
- Call Pickup / Call Park / Conference Room
- **Customization Music** on Hold / Music on Transfer
- Call Forward (Always / Busy / No answer) Internal / **External Call Forward**
- Call Transfer / Call Hold / Call Waiting / DND
- **Call Paging/ Intercom**
- **Call Monitoring**

Product Features



✓ Other Features

- Supports **Skype for SIP**
- **DDNS** Client (Supports Easy DDNS/Planet DDNS /Dyn dns.org/Zoneedit.com/No-ip)
- Troubleshooting (Ping, Traceroute)
- **Auto Provision**
- **VPN Client** (Supports PPTP/L2TP/OpenVPN)
- **VPN Server** (Supports PPTP/L2TP/OpenVPN Server)
- Black List
- Phone Book
- **SNMP V2**

Product Features - *Video Communication*

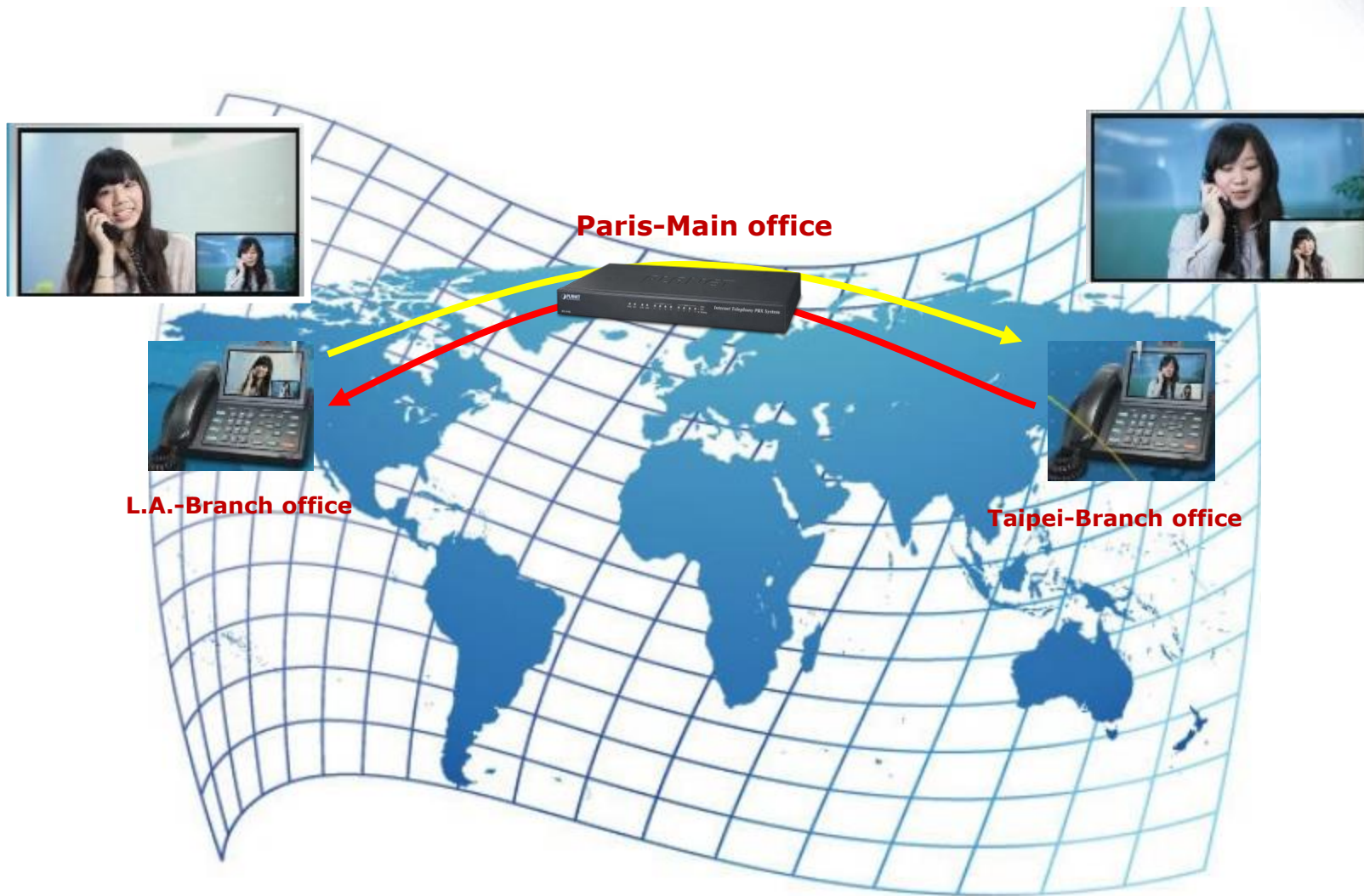

Product Features - *Paging / Intercom*

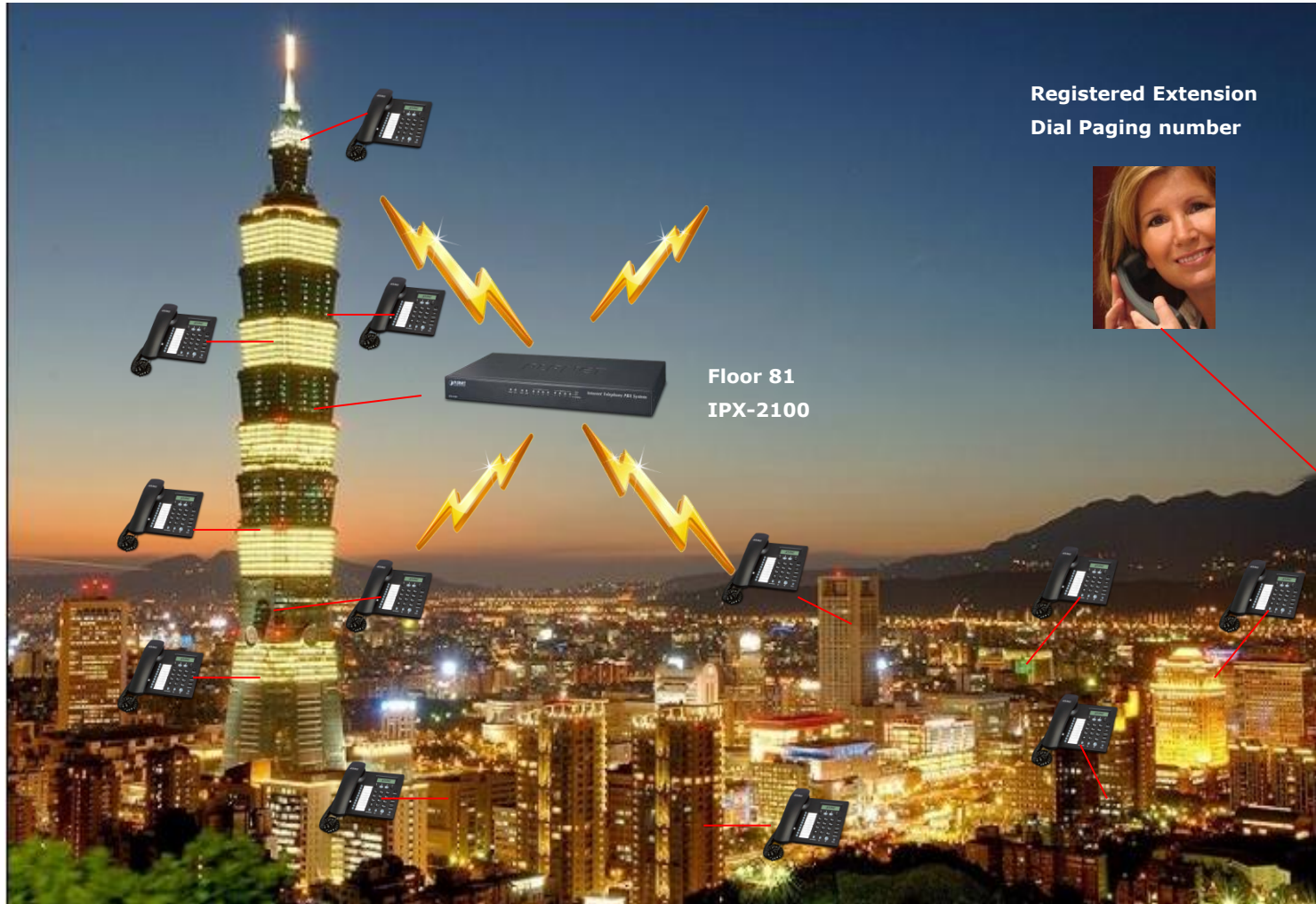

Product Features - *Fax to Email / Email to Fax*

Green Office

It's an easy and confidential way of receiving, storing and forwarding important fax documents, thus creating a paperless or green office.



Green Office (Fax to Email / Email to Fax)

Product Features - *VPN Client / VPN Server*

Full Security with VPN

The IPX-2100 VPN securely and cost-effectively connects geographically disparate offices under one umbrella, creating one cohesive virtual network.

Supports *VPN Client and VPN Server*

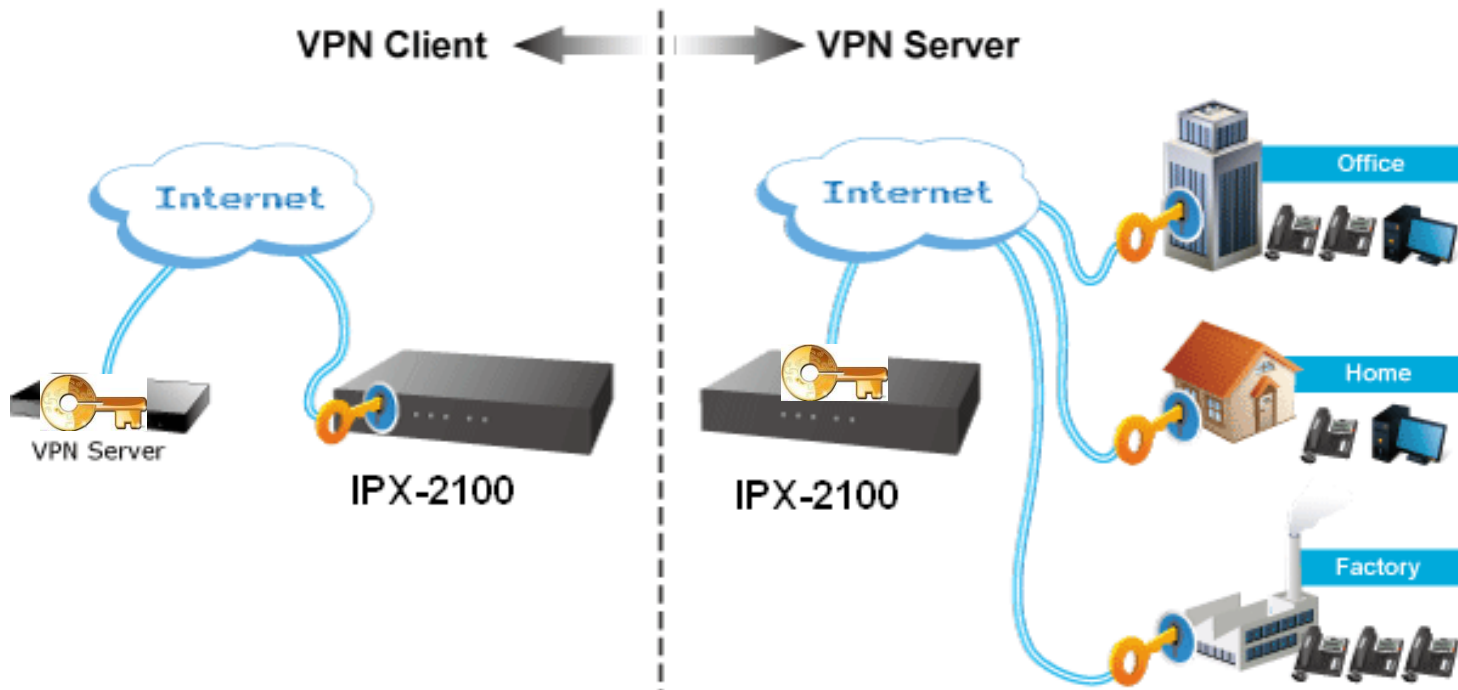

Product Applications

1. On Net Call



Make calls from Local PSTN to worldwide branches

2. Off Net Call

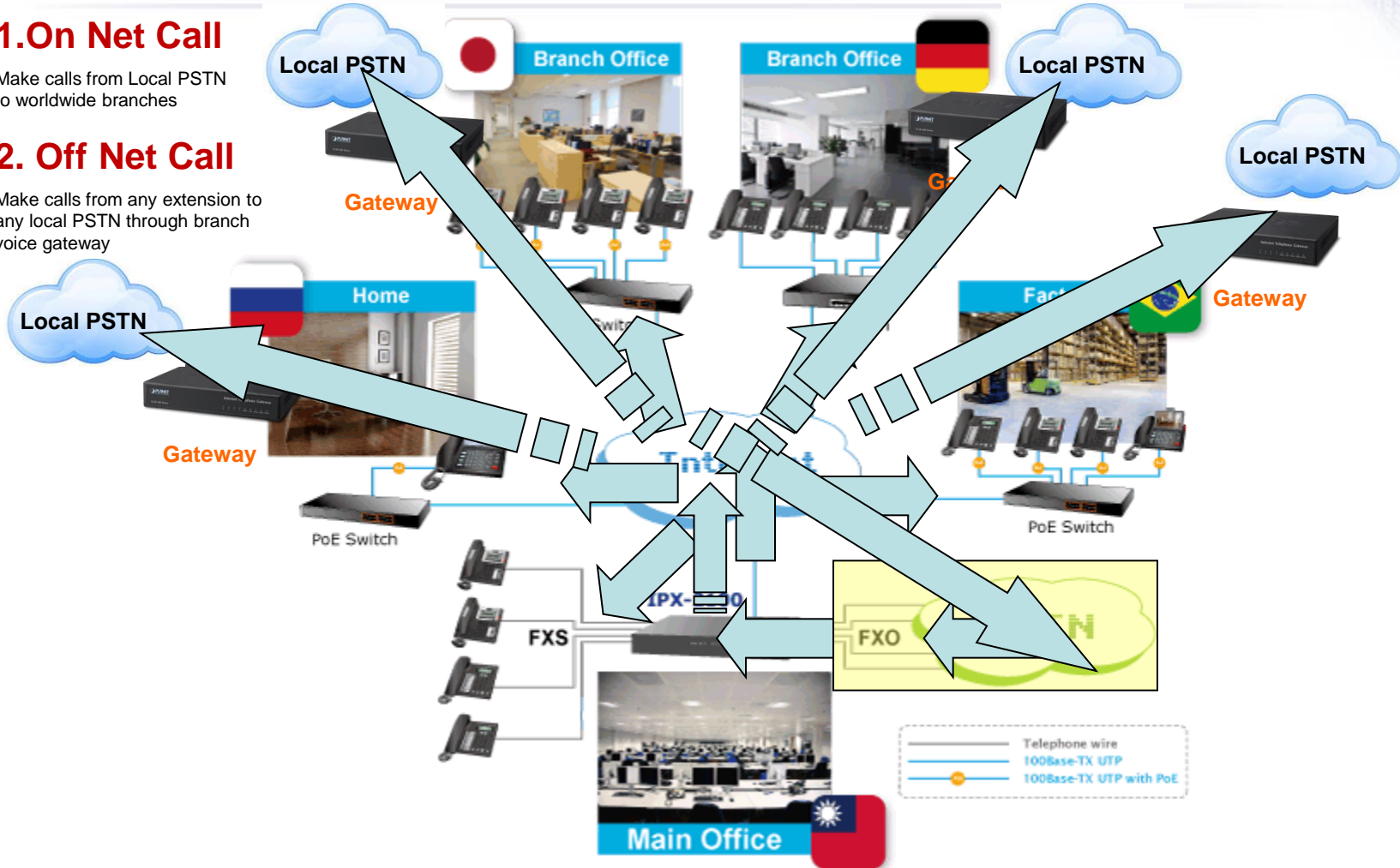
Make calls from any extension to any local PSTN through branch voice gateway



Product Comparison - Internal

Model	IPX-2100	IPX-1980
Features		
Asterisk Version	V1.8	V1.4
SIP (RFC3261) / IAX2	■	■ / -
Voice mail / Recording (GSM)	21000 minutes	6000 minutes
HD Video Codec (G.722)	■	-
IPv6	■	-
SNMPv2	■	-
VPN Server / VPN Client	■	-
Fax to Email / Email to Fax	■	-
Expansion Slot	2 Slots Maximum 8 Ports VIP-21FO: 4 x FXO VIP-21GS 4 x GSM VIP-21SL: 2 x FXO + 2FXS	8 x FXO

Product Comparison - External

Model	PLANET IPX-2100	Zyxel X2002
Features		
Expansion Slot	2 Slots Maximum 8 Ports	2 Slots Maximum 8 Ports
SIP (RFC3261) / IAX2	■	■ / -
Register Extensions	100	64
Voice mail / Recording (GSM)	21000 minutes	90 minutes
HD Video Codec (G.722)	■	-
IPv6	■	-
Firewall / SRTP	■	-
SNMPv2	■	-
VPN Server / VPN Client	■	-
Fax to Email / Email to Fax	■	-
BLF (Busy Lamp Field)	■	-
Skype for SIP	■	-
FoIP (Fax over IP)	■	-

Appendix





◆ Accessories

Model Name	Description
IPX-21FO	4-port FXO module for IPX-2100 / IPX-2500
IPX-21SL	4-port Life-Line module for IPX-2100 / IPX-2500 (2 FXO + 2 FXS)
IPX-21GS	4-port GSM module for IPX-2100 / IPX-2500



Appendix

◆ Related IP PBX

Model Name		Description
IPX-2100		Internet Telephony PBX System (100 Extensions, 2 Modular Slots)
IPX-330		Internet Telephony PBX System (30 Extensions, 2 x FXO)
UMG-1000		Desktop Unified Office Gateway (100 Extensions, 4 x FXO)
UMG-2200		Unified Office Gateway (250 Extensions, 8 x FXO)

Sales Targets

◆ Target Markets

- ✓ ISP/ITSP
- ✓ System Integrator
- ✓ Reseller



◆ Profitable Solutions

The following are potential to all customers:

* IP PBX, Voice Gateway & UMG Solutions

- IPX-1980, UMG-1000, UMG-2200
- VIP-480FO, VIP-1680/2480 Voice Gateway

* ATA Solutions

- VIP-156, VIP-156PE, VIP-157, VIP-157S

* IP Phone Solutions

- VIP-254NT, VIP-256PT
- VIP-360PT, VIP-361PE, VIP-362WT
- VIP-560PT





ACTIVATING IP POWER