

Industrial 2-/4-Port RS232/422/485 Modbus Gateway



Economical Solution for Industrial Modbus TCP/RTU/ASCII Network Integration

PLANET has added the Industrial Modbus TCP/IP Protocol to its easily-integrated industrial management level products that come with SCADA/HMI system and other data acquisition systems on factory floors. Moreover, the industrial IT SNMP network is upgraded to the industrial automation Modbus TCP/IP network. PLANET industrial management level products with the Modbus TCP/IP Protocol offer flexible network connectivity solutions for the industrial automation environment.

To complete the industrial automation environment application solution, PLANET has announced a first industrial level 2-/4-port RS232/422/485 Modbus Gateway, IMG-2x00T Series, a bridge that converts between Modbus TCP/IP Protocol and Modbus RTU/ASCII Protocol. It features a wide operating temperature range from -40 to 75 degrees C and a compact but rugged IP30/40 metal housing.

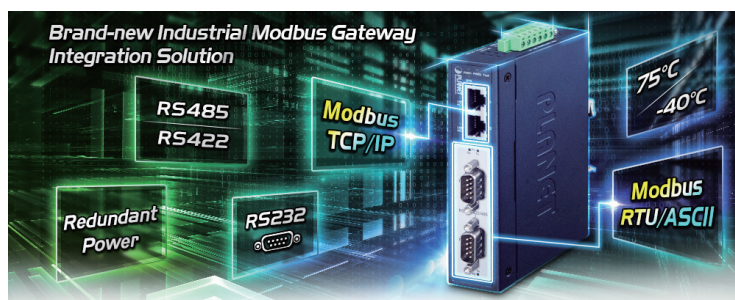

A Conversion Bridge for Flexible Network Deployment

The IMG-2x00T Series can be a conversion bridge between the equipment with the Modbus RTU/ASCII Protocol and the administrator workstations that run the Modbus TCP/IP Protocol. The RS232/422/485 serial interface of the IMG-2x00T Series provides the Modbus RTU/ASCII operation mode and various baud rate options to meet the demand of integration between the Modbus TCP/IP Protocol, Modbus RTU Master/Slave Protocol and Modbus ASCII Master/Slave Protocol.

Serial Interface

- Two/four DB9 interfaces support RS232, 2-wire RS485, 4-wire RS485 and RS422 operation
- Asynchronous serial data rates up to 921600bps

Ethernet Interface

- 2-port 10/100BASE-TX RJ45 with auto MDI/MDI-X function
- Complies with IEEE 802.3, IEEE 802.3u 10/100BASE-TX standard
- Supports 10/100BASE-TX RJ45 port with distance up to 100m

Management Function

- Built-in IP-based Web interface and telnet interface for remote management
- Software Protocol supports Modbus TCP, Modbus RTU, Modbus ASCII, IP, ARP, DHCP and DNS
- Supports RTU Master, RTU Slave, ASCII Master, and ASCII Slave four serial operation modes via management interface
- Master mode supports 32 TCP slave connection requests
- Slave mode supports 32 TCP master connections
- PLANET Modbus Gateway utility for finding client device on the network.
- PLANET Smart Discovery utility automatically finds the client devices on the network
- Firmware upgrade/configuration backup and restore via HTTP protocol

Industrial Case and Installation

- IP30/IP40 metal case
- DIN-rail and wall-mount designs
- Redundant power design
 - 12 to 48V DC, redundant power with reverse polarity protection
- Supports 6000 VDC Ethernet ESD protection
- Free fall, shock-proof and vibration-proof for industries

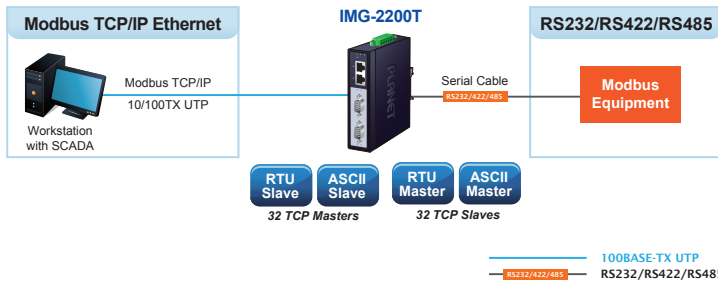

The advantage of having the IMG-2X00T Series is to assist users to build an industrial environment between the Modbus TCP/IP Protocol and the Modbus RTU/ASCII Protocol easily, thus offering an application solution to the industrial control equipment without Ethernet ports and the industrial control equipment can only control through an industrial PC workstation or industrial control panel.

In addition, the effective integration solution of Modbus Ethernet devices, Modbus serial equipment or multi Modbus master/slave in an industrial hybrid network brings the following:

- Master mode supports up to 32 TCP slave connection requests
- Slave mode supports up to 32 TCP master connections

Remote Management

The IMG-2x00T Series makes the connected industrial Modbus RTU/ASCII equipment become IP-based facilities and is able to connect to the Modbus TCP/IP network via its RS232/422/485 serial interface and 10/100BASE-TX RJ45 Ethernet port. It provides a remote web management and telnet interface for efficient remote network management. The IMG-2x00T Series also provides PLANET Modbus Gateway utility tool and supports PLANET Smart Discovery utility to help network administrator to easily get the current IP subnet address information or change the IP subnet address setting of the IMG-2x00T Series.

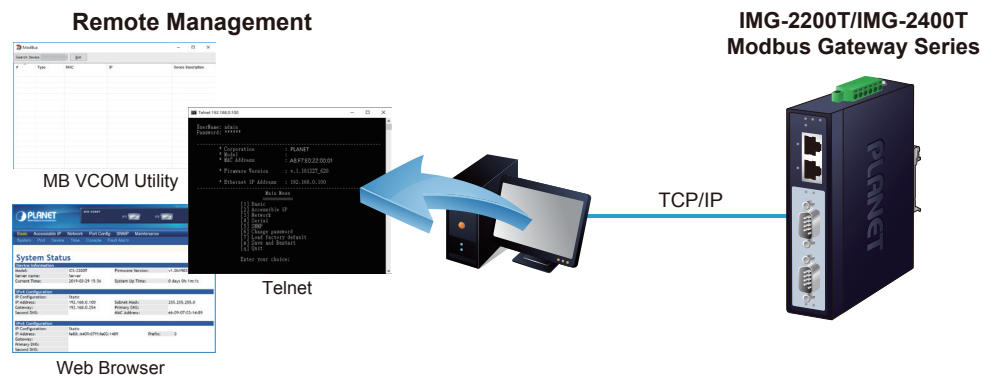

Modbus Serial Port State Monitoring

The IMG-2x00T Series shows the details of the total bytes transmitted and received on the RS232/422/485 serial interface, and the detailed total number of frames transmitted and received on the remote web/telnet management interface. This function allows network administrator to check the status and statistics of the IMG-2x00T Series via the single RS232/422/485 serial interface.

Stable Performance in Hardened Environment Design

The IMG-2x00T Series provides a high level of immunity against electromagnetic interference and heavy electrical surges which are usually found on plant floors or in curb-side traffic control cabinets. Its operating temperature ranging from -40 to 75 degrees C allows the IMG-2x00T Series to be placed in almost any difficult environment.

The IMG-2x00T Series is equipped with a compact IP30/40-rated metal case that allows wall mounting for efficient use of cabinet space. The IMG-2x00T Series also provides an integrated power supply source with wide-ranging voltages (12 to 48V DC) ideally suitable for worldwide operation with high availability applications.

- Supports extensive LED indicators for network diagnosis
- -40 to 75 degrees C operating temperature
- Reset button for reset to factory default

Digital Input and Digital Output (IMG-2400T)

- 2 Digital Input (DI)
- 2 Digital Output (DO)
- Integrate sensors into auto alarm system
- Transfer alarm to IP network via email and SNMP trap

Effective Alarm Alert for Better Protection

The IMG-2x00T series comes with a Fault Alarm feature which can alert the users when there is something wrong with the Serial Device Server. With this ideal feature, the users would not have to waste time finding where the problem is. It will help to save time and human resource. The IMG-2x00T Series provides event alert function to help to diagnose the abnormal device owing to whether or not there is a break of the network connection, or the rebooting response.

Fault Alarm Feature

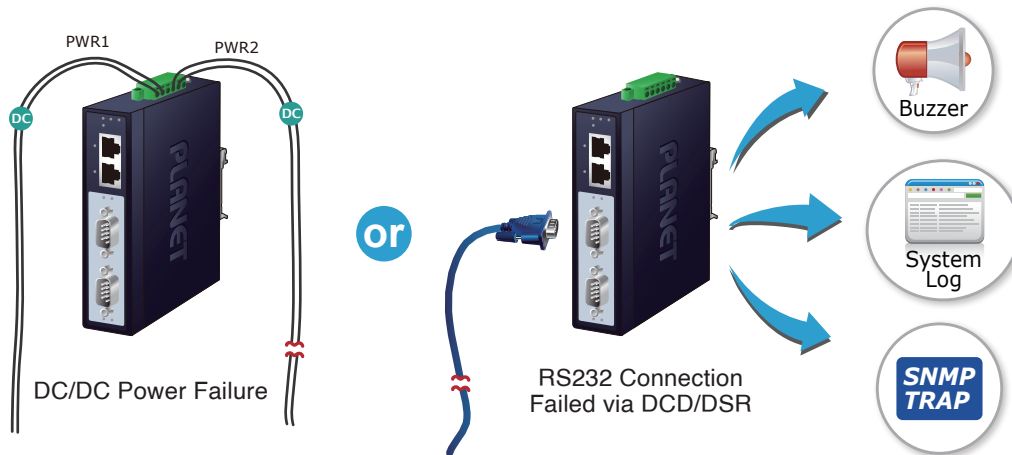

Dual Power Input for High Availability Network System

The IMG-2x00T Series features a strong dual power input system with wide-ranging voltages (12V~48V DC) incorporated into customer's automation network to enhance system reliability and uptime. In the example below, when Power Supply 1 fails to work, the hardware failover function will be activated automatically to keep powering the IMG-2x00T Series via Power Supply 2 without any break of operation.

Non-stop Ethernet Service with Dual Power Input & Auto Failover

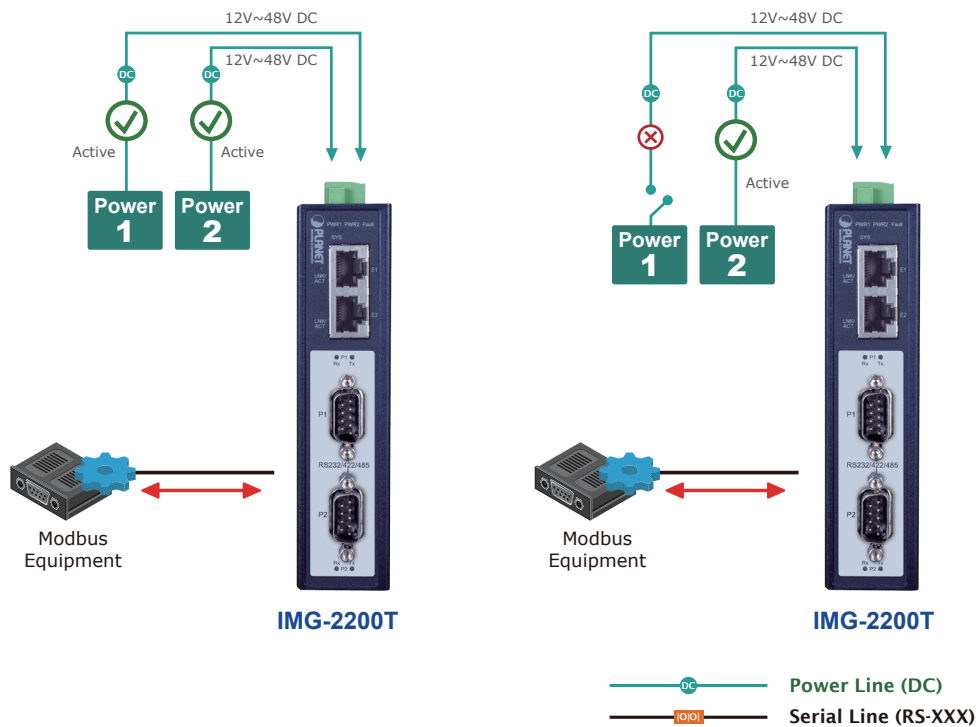

Digital Input and Digital Output for External Alarm (only 2400T)

With digital input and digital output on its front panel, an external alarm can help users via the digital input to detect and log external device status (such as door intrusion detector), and then immediately send an event alarm to the administrator. The digital output can be used to alarm the administrator if the IMG-2400T serial port shows DCD, changed DSR or power failure.

Applications

RTU/ASCII Master to Multi Modbus TCP/IP Slaves

The IMG-2x00T Series can act as a bridge between the industrial RTU/ASCII master equipment and the multi-industrial TCP/IP slave equipment in a Modbus TCP/IP networking environment to control multi-industrial TCP/IP slave equipment via the industrial RTU/ASCII master equipment.

RTU/ASCII Master to Multi Modbus TCP/IP Slaves

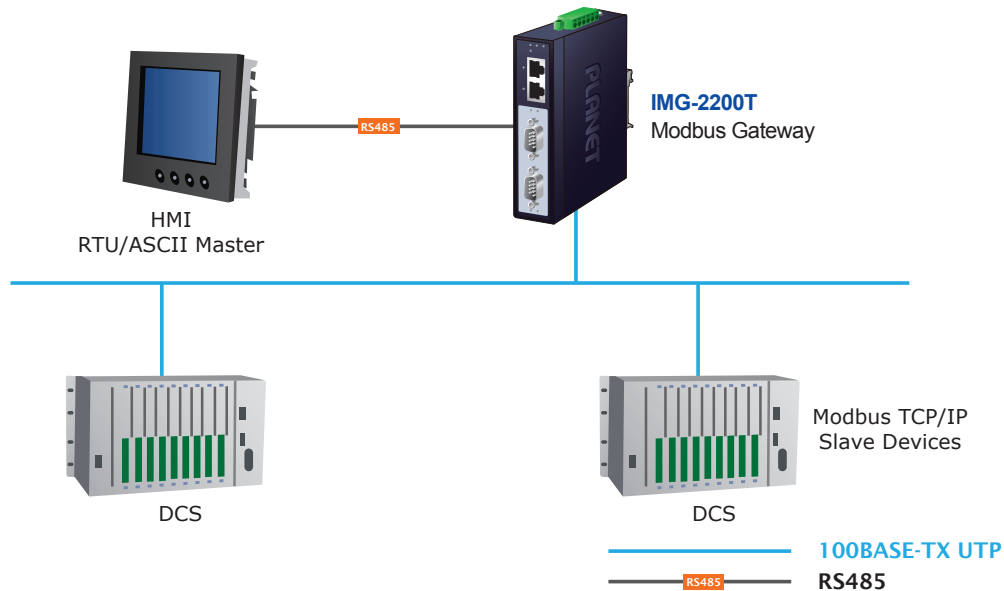

Multi Modbus TCP/IP Master to RTU/ASCII Slaves

The IMG-2X00T Series can operate as a bridge between the multi-industrial TCP/IP master equipment and the industrial RTU/ASCII slave equipment in a Modbus TCP/IP networking environment to control the industrial RTU/ASCII slave equipment via the multi-industrial TCP/IP master equipment.

Multi Modbus TCP/IP Master to RTU/ASCII Slaves

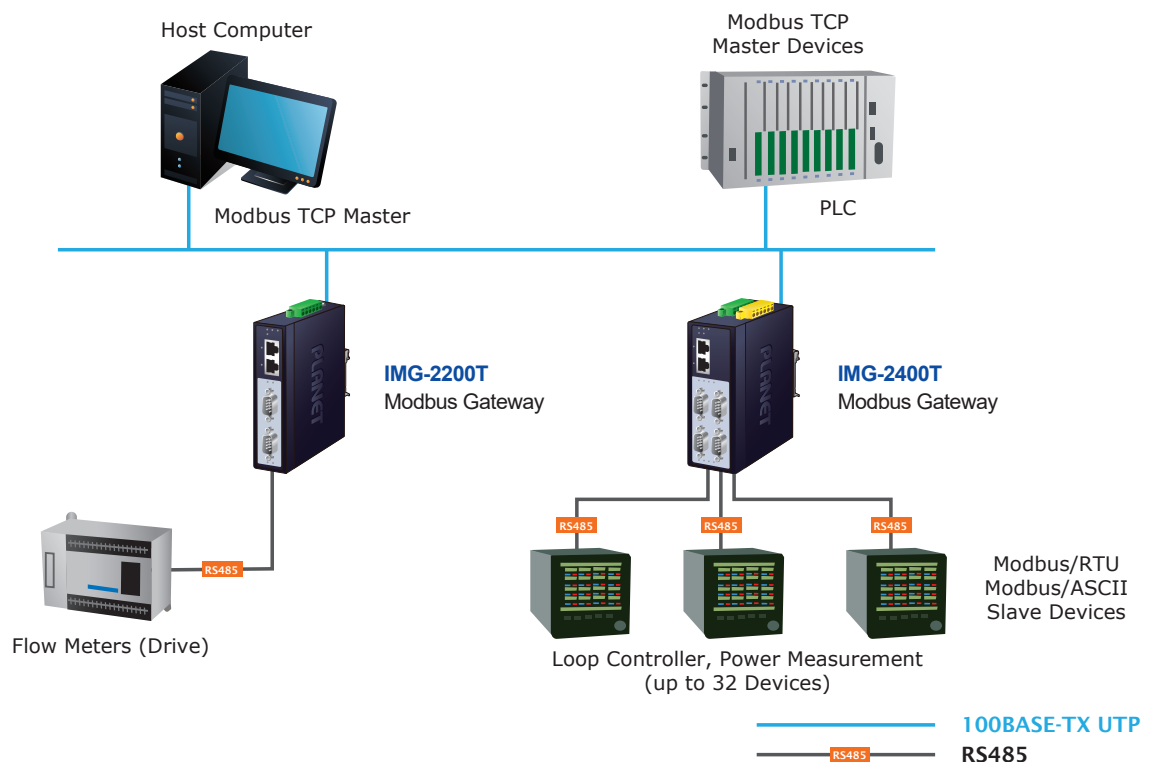

Drawing

■ IMG-2200T

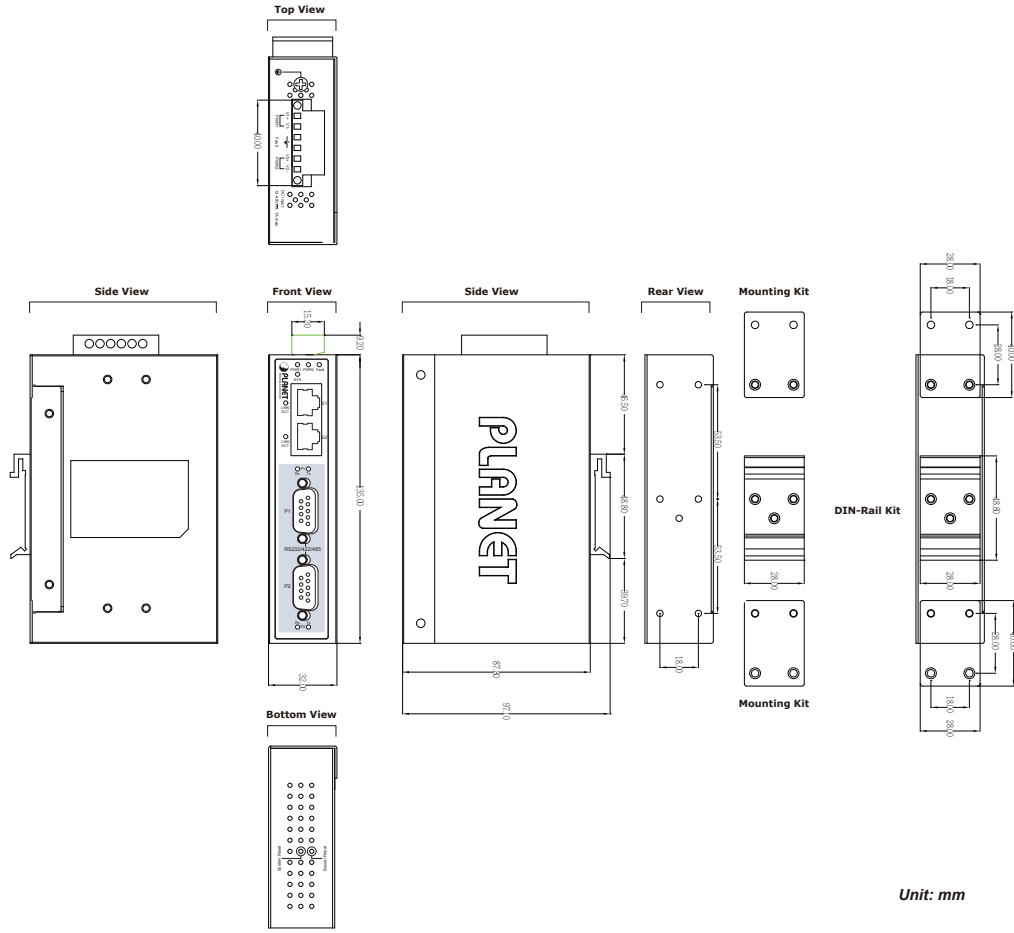

■ IMG-2400T

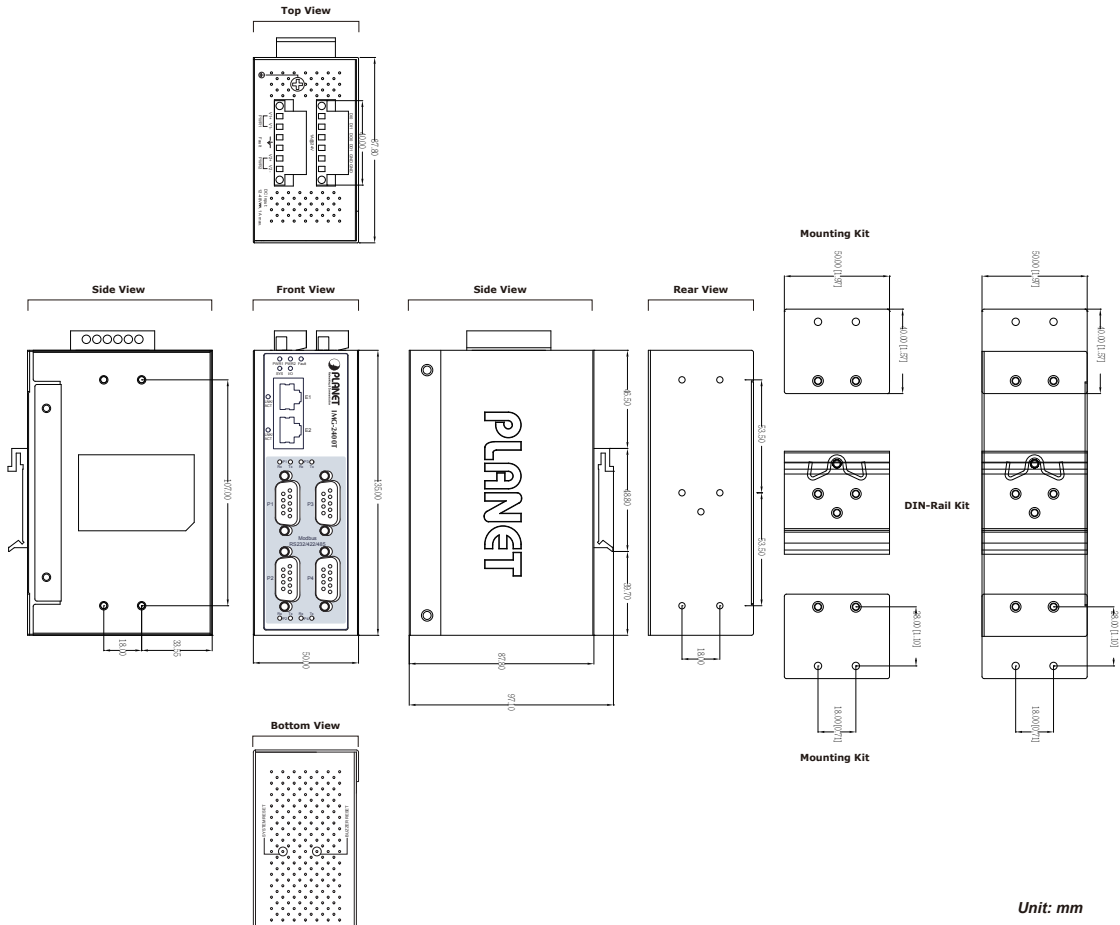

Specifications

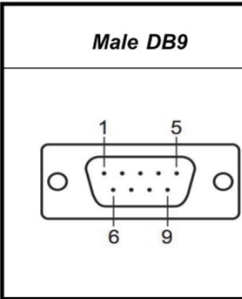
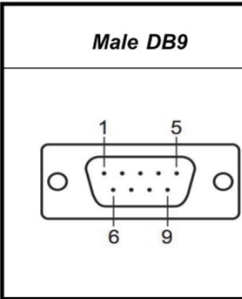
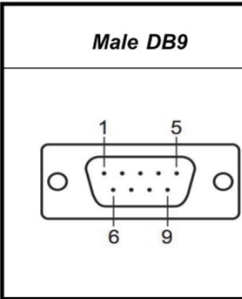
Product	IMG-2200T	IMG-2400T																																										
Serial Interface																																												
Serial Ports	2 x DB9 male	4 x DB9 male																																										
Serial Standards	RS232 / 4-wire RS422 or RS485 / 2-wire RS485																																											
Baud Rate (Data Rate)	50bps to 921Kbps																																											
Data Bits	5, 6, 7, 8																																											
Parity Type	1, 1.5, 2																																											
Stop Bit	Odd, Even, None, Space, Mark																																											
Flow Control	RTS/CTS and DTR/DSR (RS232 only) XON/XOFF																																											
Signals	RS232: TxD, RxD, RTS, CTS, DTR, DSR, DCD, GND RS422: Tx+, Tx-, Rx+, Rx-, GND 4-wire RS485: Tx+, Tx-, Rx+, Rx-, GND 2-wire RS485: Data A (+), Data B (-), GND																																											
Pin Assignment	<table border="1"> <thead> <tr> <th>Male DB9</th> <th>Pin</th> <th>RS232</th> <th>RS422 RS485-4W</th> <th>RS485-2W</th> </tr> </thead> <tbody> <tr> <td rowspan="9">  </td> <td>1</td> <td>DCD</td> <td>TxD+</td> <td>--</td> </tr> <tr> <td>2</td> <td>RxD</td> <td>TxD-</td> <td>--</td> </tr> <tr> <td>3</td> <td>TxD</td> <td>RxD-</td> <td>Data-</td> </tr> <tr> <td>4</td> <td>DTR</td> <td>RxD+</td> <td>Data+</td> </tr> <tr> <td>5</td> <td>GND</td> <td>GND</td> <td>GND</td> </tr> <tr> <td>6</td> <td>DSR</td> <td>--</td> <td>--</td> </tr> <tr> <td>7</td> <td>RTS</td> <td>--</td> <td>--</td> </tr> <tr> <td>8</td> <td>CTS</td> <td>--</td> <td>--</td> </tr> <tr> <td>9</td> <td>--</td> <td>--</td> <td>--</td> </tr> </tbody> </table>		Male DB9	Pin	RS232	RS422 RS485-4W	RS485-2W		1	DCD	TxD+	--	2	RxD	TxD-	--	3	TxD	RxD-	Data-	4	DTR	RxD+	Data+	5	GND	GND	GND	6	DSR	--	--	7	RTS	--	--	8	CTS	--	--	9	--	--	--
Male DB9	Pin	RS232	RS422 RS485-4W	RS485-2W																																								
	1	DCD	TxD+	--																																								
	2	RxD	TxD-	--																																								
	3	TxD	RxD-	Data-																																								
	4	DTR	RxD+	Data+																																								
	5	GND	GND	GND																																								
	6	DSR	--	--																																								
	7	RTS	--	--																																								
	8	CTS	--	--																																								
	9	--	--	--																																								
Operation Mode	RTU Master/RTU Slave/ASCII Master/ASCII Slave Master mode: Supports up to 32 TCP slave connection requests Slave mode: Supports up to 32 TCP master connection requests																																											
Serial Line Protection	2KV isolation protection 1KV (level 2) surge protection 15KV ESD protection																																											
Ethernet Interface																																												
Ethernet Ports	2 x RJ45																																											
Standard	10/100BASE-TX																																											
Distance	100m																																											
Switch Architecture	Store-and-Forward-																																											
Address Table	1K																																											
ESD Protection	6KV																																											
Surge Protection	2KV																																											
Hardware																																												
Installation	DIN-rail kit and wall-mount ear																																											
Enclosure	IP30/40 metal	IP 40 metal																																										
Dimensions (W x D x H)	32 x 87.8 x 135 mm	50 x 87 x 135 mm																																										
Weight	392g	625 g																																										
LED Indicators	System: Power 1, Power 2, Fault, SYS TP Port: Link/ Active Serial Port: Tx and Rx	System: Power 1, Power 2, Fault, SYS,I/O TP Port: LEink/ Active Serial Port: Tx and Rx																																										
Power Requirements	12~48V DC, redundant power with polarity reverse protection function																																											
Power Consumption	Full Loading 12VDC: 0.326A (3.8 watts) 24VDC: 0.176A (4.2 watts) 48VDC: 0.114A (5.4 watts)	Full Loading 12VDC: 0.419A (5.1 watts) 24VDC: 0.227A (5.4 watts) 48VDC: 0.136A (6.5 watts)																																										
Connector	Removable 6-pin terminal block for power input Pin 1/2 for Power 1, Pin 3/4 for fault alarm, Pin 5/6 for Power 2																																											
DI and DO	N/A	2 Digital Input (DI): Level 0: -24V~2.1V (±0.1V) Level 1: 2.1V~24V (±0.1V) Input Load to 24V DC, 10mA max. 2 Digital Output (DO): Open collector to 24V DC, 100mA max.																																										

Alarm	Provides one relay output for power failure Alarm relay current carry ability: 1A @ DC 24V
Reset Button	< 5 sec: System reboot > 5 sec: Factory default
Management	
Management Interfaces	Web management Telnet Console management Windows-based VCOM Utility management SNMPv1, v2c / SNMP Trap UNI-NMS monitoring PLANET Smart Discovery Utility
IP Version	IPv4 and IPv6
Operation Mode	RTU Master RTU Slave ASCII Master ASCII Slave
Virtual COM Utility Platform Supports	Windows-based only: Windows XP Windows Server 2003 Windows 7 Windows Server 2008 Windows 8 (Must install the latest version of WinPcap) Windows Server 2012 (Must install the latest version of WinPcap) Windows 10
Fault Alarm	Record: System log / SNMP trap
Time	NTP
Security	Allow max. 4 accessible IP address hosts/ranges
SNMP MIBs	RFC1213 MIB-II RFC1317 RS232-like MIB
Standards Conformances	
Regulatory Compliance	FCC Part 15 Class A, CE Certification Class A
Stability Testing	IEC60068-2-32 (Free fall) IEC60068-2-27 (Shock) IEC60068-2-6 (Vibration)
Standards	IEEE 802.3 10BASE-T IEEE 802.3u 100BASE-TX RFC 768 UDP RFC 793 TFTP RFC 791 IP RFC 792 ICMP RFC 854 Telnet RFC 958 NTP RFC 1591 DNS (client only) RFC 1908 SNMPv2c RFC 2068 HTTP RFC 2131 DHCP Client RFC 2732 Format for Literal IPv6 Addresses in URL's RFC 3315 DHCPv6 Client RFC 3513 IPv6 Addressing Architecture RFC 3596 DNSv6 RFC 4443 ICMPv6 EIA/TIA RS232/422/485
Environment	
Operating Temperature	-40 ~ 75 degrees C
Storage Temperature	-40 ~ 85 degrees C
Humidity	5 ~ 95% (non-condensing)

Ordering Information

IMG-2200T	IP30 Industrial 2-Port RS232/RS422/RS485 Modbus Gateway (2 x 10/100TX, -40~75 degrees C, 2KV isolation)
IMG-2400T	IP40 Industrial 4-Port RS232/RS422/RS485 Modbus Gateway (2 x 10/100TX, -40~75 degrees C, 2KV isolation, 2 x DI + 2 x DO)

Related Products

MG-110	1-port RS232/422/485 Modbus Gateway (-10~60 degrees C)
MG-115A	1-port RS232/422/485 Modbus Gateway with 1-port 100BASE-FX SFP (-10~60 degrees C)
IMG-110T	Industrial 1-port RS422/485 Modbus Gateway (9~48VDC, -40~75 degrees C)
IMG-120T	Industrial 2-port RS422/485 Modbus Gateway (9~48VDC, -40~75 degrees C)
IMG-2100T	IP30 Industrial 1-Port RS232/RS422/RS485 Modbus Gateway (1 x 10/100TX, -40~75 degrees C)
IMG-2105AT	IP30 Industrial 1-Port RS232/RS422/RS485 Modbus Gateway (1 x 100FX, -40~75 degrees C)