

User's Manual

802.11a/n Wireless Outdoor AP

▶ WNAP-7320

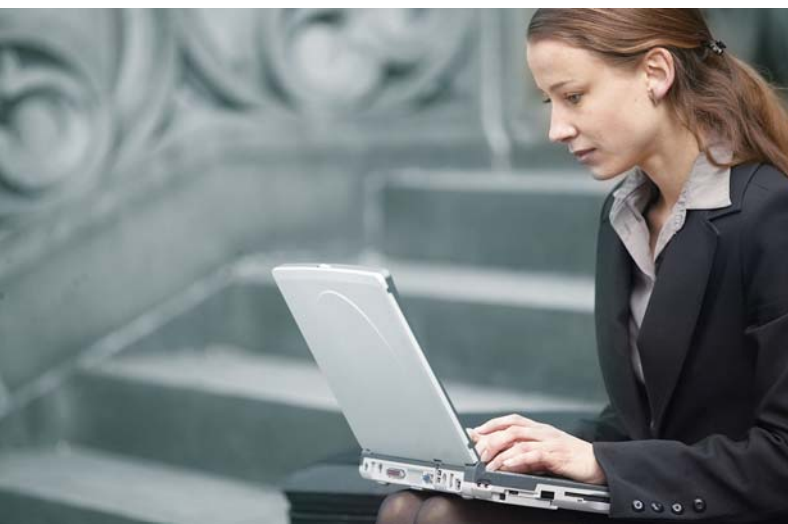

Copyright

Copyright © 2013 by PLANET Technology Corp. All rights reserved. No part of this publication may be reproduced, transmitted, transcribed, stored in a retrieval system, or translated into any language or computer language, in any form or by any means, electronic, mechanical, magnetic, optical, chemical, manual or otherwise, without the prior written permission of PLANET.

PLANET makes no representations or warranties, either expressed or implied, with respect to the contents hereof and specifically disclaims any warranties, merchantability or fitness for any particular purpose. Any software described in this manual is sold or licensed "as is". Should the programs prove defective following their purchase, the buyer (and not this company, its distributor, or its dealer) assumes the entire cost of all necessary servicing, repair, and any incidental or consequential damages resulting from any defect in the software. Further, this company reserves the right to revise this publication and to make changes from time to time in the contents hereof without obligation to notify any person of such revision or changes.

All brand and product names mentioned in this manual are trademarks and/or registered trademarks of their respective holders.

Federal Communication Commission Interference Statement

This equipment has been tested and found to comply with the limits for a Class A digital device,  pursuant to part 15 of the FCC Rules. These limits are designed to provide reasonable protection against harmful interference when the equipment is operated in a commercial environment. This equipment generates, uses, and can radiate radio frequency energy and, if not installed and used in accordance with the instruction manual, may cause harmful interference to radio communications. Operation of this equipment in a residential area is likely to cause harmful interference in which case the user will be required to correct the interference at his/her own expense. Any changes or modifications not expressly approved by PLANET could void the user's authority to operate this equipment under the rules and regulations of the FCC.

FCC Caution:

To assure continued compliance, (example-use only shielded interface cables when connecting to computer or peripheral devices) any changes or modifications not expressly approved by the party responsible for compliance could void the user's authority to operate the equipment.

This device complies with Part 15 of the FCC Rules. Operation is subject to the Following two conditions:

- (1) This device may not cause harmful interference
- (2) This Device must accept any interference received, including interference that may cause undesired operation.

Federal Communication Commission (FCC) Radiation Exposure Statement

This equipment complies with FCC radiation exposure set forth for an uncontrolled environment. In order to avoid the possibility of exceeding the FCC radio frequency exposure limits, human proximity to the antenna shall not be less than 20 cm (8 inches) during normal operation.



This is a Class B product. In a domestic environment, this product may cause radio interference, in which case the user may be required to take adequate measures.

Energy Saving Note of the Device

This power required device does not support Standby mode operation.

For energy saving, please remove the DC-plug to disconnect the device from the power circuit. Without remove the DC-plug, the device still consuming power from the power circuit. In the view of Saving the Energy and reduce the unnecessary power consuming, it is strongly suggested to remove the DC-plug for the device if this device is not intended to be active.

R&TTE Compliance Statement

This equipment complies with all the requirements of DIRECTIVE 1999/5/CE OF THE EUROPEAN PARLIAMENT AND THE COUNCIL OF 9 March 1999 on radio equipment and telecommunication terminal Equipment and the mutual recognition of their conformity (R&TTE).

The R&TTE Directive repeals and replaces in the directive 98/13/EEC (Telecommunications Terminal Equipment and Satellite Earth Station Equipment) As of April 8, 2000.

Safety

This equipment is designed with the utmost care for the safety of those who install and use it. However, special attention must be paid to the dangers of electric shock and static electricity when working with electrical equipment. All guidelines of this and of the computer manufacture must therefore be allowed at all times to ensure the safe use of the equipment.

WEEE regulation



To avoid the potential effects on the environment and human health as a result of the presence of hazardous substances in electrical and electronic equipment, end users of electrical and electronic equipment should understand the meaning of the crossed-out wheeled bin symbol. Do not dispose of WEEE as unsorted municipal waste and have to collect such WEEE separately.

Revision

User's Manual for PLANET 802.11a/n Wireless Outdoor Access Point

Model: WNAP-7320

Rev: 1.0 (March, 2013)

Part No. EM-WNAP-7320_v1.0 (**2081-E10530-000**)

CONTENTS

Chapter 1.Product Introduction	1
1.1 Package Contents	1
1.2 Product Description	2
1.3 Product Features	5
1.4 Product Specification	6
Chapter 2.Hardware Installation	9
2.1 Hardware Description	9
2.1.1 The Side Panel – LED	10
2.1.2 The Rear Panel – Mounting Design	11
2.1.3 The Bottom Panel – Port	12
Chapter 3.Connecting to the AP	13
3.1 Preparation before Installation	13
3.1.1 Professional Installation Required	13
3.1.2 Safety Precautions.....	13
3.2 Installation Precautions	13
3.3 Installing the AP	15
3.4 Standard Pole Mounting	17
3.5 Adjustable Pole Mounting	17
3.6 Wall Mounting	18
Chapter 4.Quick Installation Guide	19
4.1 Manual Network Setup - TCP/IP Configuration	19
4.1.1 Configure the IP Address Manually	19
4.2 Starting Setup in the Web UI	23
Chapter 5.Configuring the AP	25
5.1 Status	25
5.2 Easy Setup	28
5.3 Advanced	29
5.3.1 Advanced - Management.....	29
5.3.1.1. Web Interface Settings (Password).....	30
5.3.1.2. Firmware Upgrade	30
5.3.1.3. Configuration.....	31
5.3.1.4. Load Factory Defaults	32
5.3.1.5. Reboot System	32
5.3.1.6. Scheduling Reboot.....	33
5.3.2 Advanced – Advanced Settings	33
5.3.2.1. Time Zone Settings	34
5.3.2.2. DDNS Settings.....	34
5.3.2.3. UPNP Settings	38

5.3.2.4.	SNMP Settings.....	39
5.3.3	Advanced – Operation Mode.....	39
5.3.3.1.	AP Router (AP+Router).....	40
5.3.3.2.	AP Bridge (AP+WDS).....	40
5.3.3.3.	Client Router (WISP).....	41
5.3.3.4.	Client Bridge (Slave AP Bridge).....	45
5.3.4	Advanced – System Log.....	46
5.3.5	Advanced – Tools.....	46
5.3.5.1.	Ping.....	47
5.3.5.2.	Traceroute.....	47
5.3.5.3.	Throughput.....	48
5.4	Firewall Settings.....	48
5.4.1	MAC/IP/Port Filtering.....	48
5.4.2	Virtual Server.....	50
5.4.3	DMZ.....	51
5.4.4	Firewall.....	51
5.4.5	QoS.....	52
5.4.6	Content Filtering.....	54
5.4.6.1.	Webs URL Filter Settings.....	54
5.4.6.2.	Web Host Filter Settings.....	55
5.5	Network Settings.....	55
5.5.1	WAN.....	55
5.5.1.1.	Static (Fixed IP).....	55
5.5.1.2.	Cable/Dynamic IP (DHCP).....	56
5.5.1.3.	PPPoE (ADSL).....	57
5.5.1.4.	IPSEC.....	58
5.5.1.5.	PPTP.....	62
5.5.1.6.	L2TP.....	63
5.5.2	LAN.....	64
5.5.2.1.	DHCP Server.....	65
5.5.2.2.	DHCP Relay.....	65
5.5.3	VLAN.....	66
5.5.4	Advanced Routing.....	67
5.5.5	IPv6.....	68
5.6	Wireless Settings.....	69
5.6.1	Basic.....	69
5.6.1.1.	Wireless Mode – Access Point.....	69
5.6.1.2.	Wireless Mode – WDS Access Point.....	71
5.6.1.3.	Wireless Mode – WDS Repeater.....	73
5.6.1.4.	Wireless Mode – WDS Client.....	75
5.6.2	Profile Settings.....	77
5.6.3	Advanced.....	79

5.6.4	Access Control.....	80
5.7	Logout.....	81
Appendix A:	FAQ.....	82
A.1	What and how to find my PC's IP and MAC address?	82
A.2	What is Wireless LAN?.....	82
A.3	What are ISM bands?.....	82
A.4	How does wireless networking work?.....	82
A.5	What is BSSID?	83
A.6	What is ESSID?	83
A.7	What are potential factors that may causes interference?.....	83
A.8	What are the Open System and Shared Key authentications?	84
A.9	What is WEP?.....	84
A.10	What is Fragment Threshold?	84
A.11	What is RTS (Request to Send) Threshold?	85
A.12	What is Beacon Interval?	85
A.13	What is Preamble Type?.....	85
A.14	What is SSID Broadcast?	85
A.15	What is Wi-Fi Protected Access (WPA)?	86
A.16	What is WPA2?.....	86
A.17	What is 802.1x Authentication?.....	86
A.18	What is Temporal Key Integrity Protocol (TKIP)?.....	86
A.19	What is Advanced Encryption Standard (AES)?.....	86
A.20	What is Inter-Access Point Protocol (IAPP)?.....	86
A.21	What is Wireless Distribution System (WDS)?	87
A.22	What is Universal Plug and Play (UPnP)?	87
A.23	What is Maximum Transmission Unit (MTU) Size?	87
A.24	What is Clone MAC Address?	87
A.25	What is DDNS?	87
A.26	What is NTP Client?.....	87
A.27	What is VPN?.....	87
A.28	What is IPSEC?	88
A.29	What is WLAN Block Relay between Clients?	88
A.30	What is WMM?.....	88
A.31	What is WLAN ACK TIMEOUT?	88
A.32	What is Modulation Coding Scheme (MCS)?.....	88
A.33	What is Frame Aggregation?	88
A.34	What is Guard Intervals (GI)?	89
Appendix B:	Configuring the PC in Windows 7.....	90

Appendix C: Use Planet Smart Discovery to find AP	93
Appendix D: Specifications.....	94

Chapter 1. Product Introduction

1.1 Package Contents

Thank you for choosing PLANET WNAP-7320. Before installing the AP, please verify the contents inside the package box.

WNAP-7320 Wireless AP



Quick Installation Guide

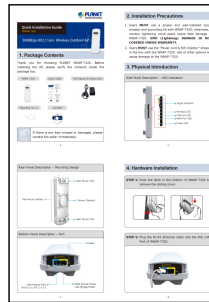

CD-ROM



(User Manual included)

PoE Injector & Power Cord



Mounting Tie x 2



If there is any item missed or damaged, please contact the seller immediately.

1.2 Product Description



High Power Outdoor Wireless Coverage

PLANET Technology introduces the latest high power outdoor wireless LAN solution - the 300Mbps outdoor wireless AP, WNAP-7320. It provides **higher transmit power, better performance, widely coverage and stable connection** than standard outdoor wireless AP. As an IEEE 802.11a/n compliant wireless device, the WNAP-7320 is able to give stable and efficient wireless performance for long distance application; while designed with IEEE 802.11n standard and 2T2R MIMO technology makes it possible to deliver six times faster data rate up to 300Mbps than normal 802.11a wireless device. It also features adjustable output power up to 500mW to extend higher coverage in outdoor long range application.

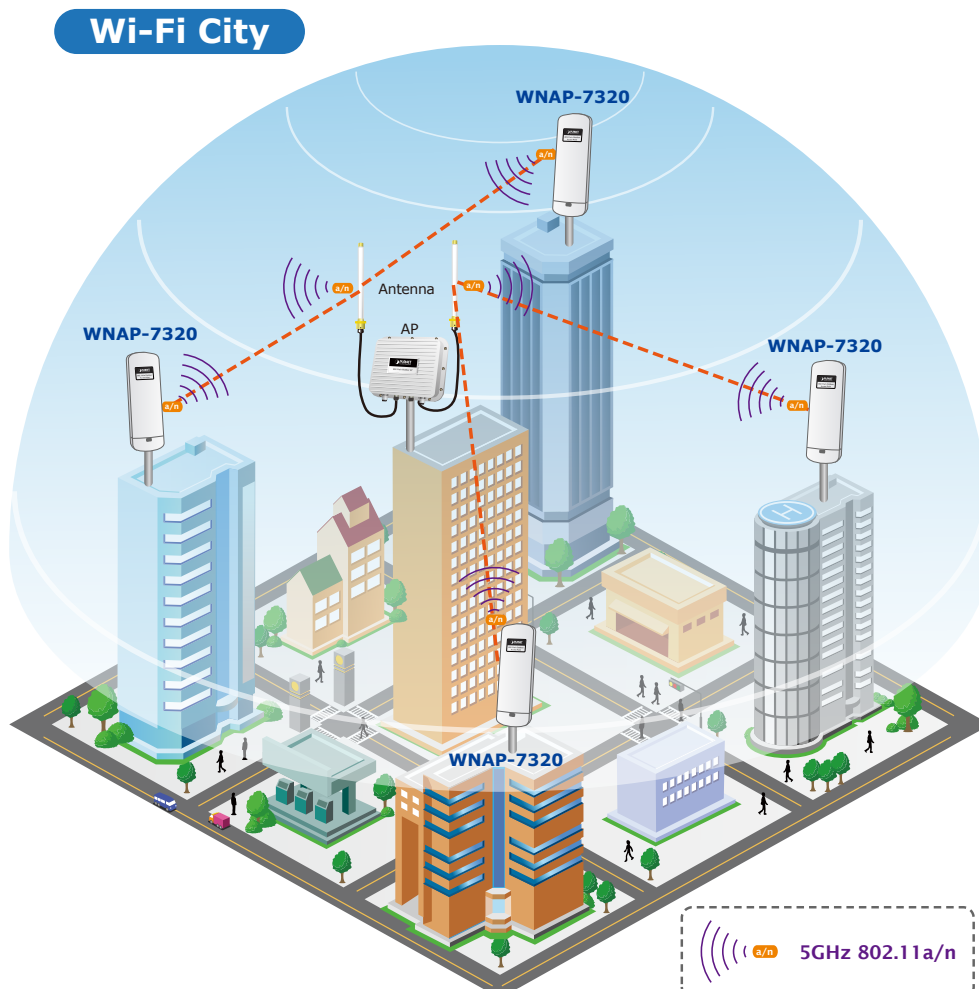

Multiple Operating & Wireless Modes

The WNAP-7320 supports multiple wireless communication connectivity (AP / Client CPE / WDS PtP / WDS PtMP / Repeater) allowing for various application requirements and thus it gives users more comprehensive experience when using the WNAP-7320. It helps users to easily build a wireless network and extend the wireless range of existing wireless network.

The WNAP-7320 also supports WISP mode, so CPE users could easily connect to Internet via WISP provider or connect to a wired network.

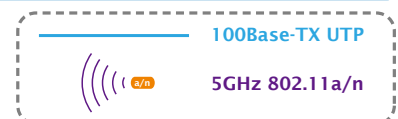
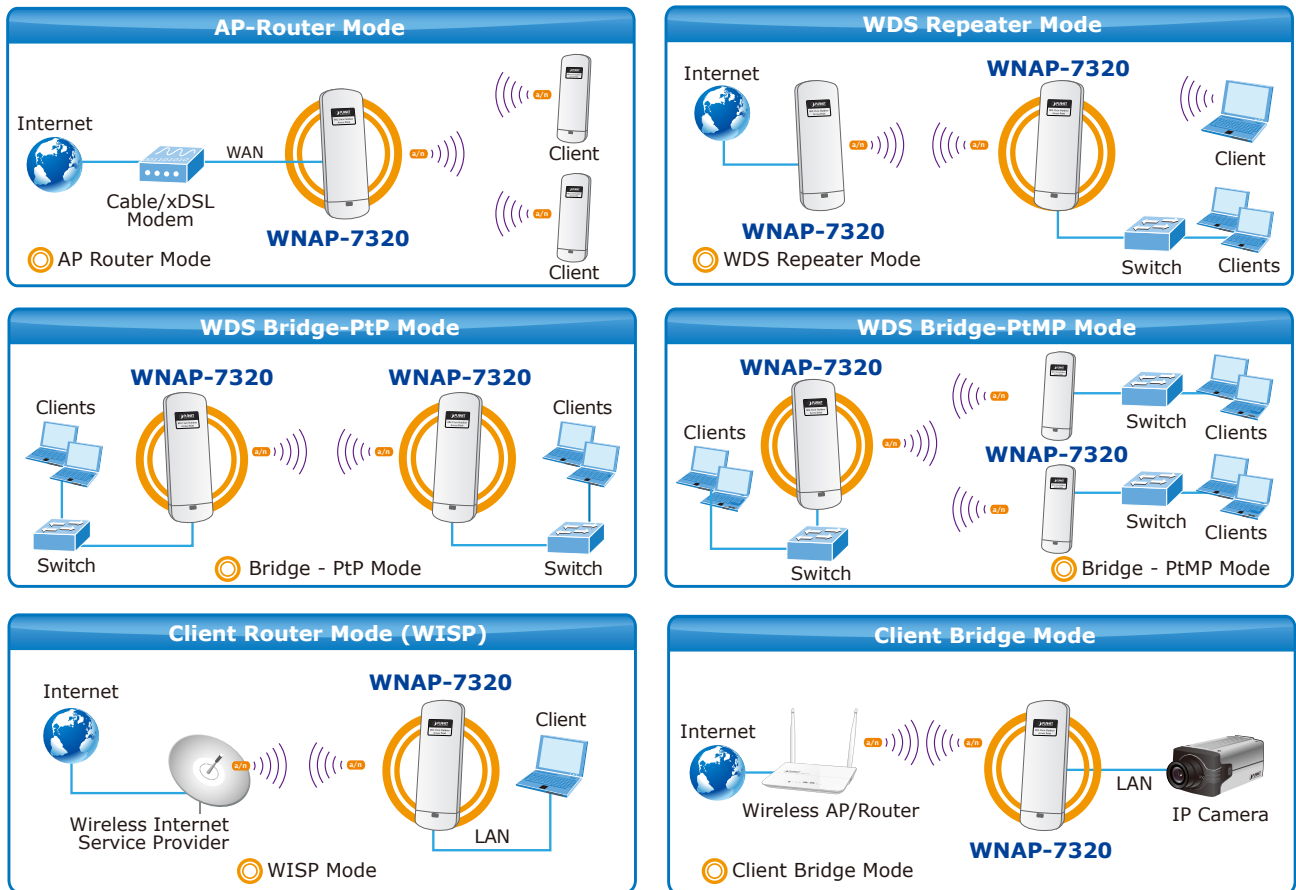

Advanced Security and Management

In aspect of security, besides 64/128-bit WEP encryption, the WNAP-7320 integrates WPA / WPA2, WPA-PSK / WPA2-PSK and 802.1x authority to secure and protect your wireless LAN. The wireless MAC filtering and SSID broadcast control consolidate the wireless network security and prevent unauthorized wireless connection. To fulfill enterprise and various applications demand, the WNAP-7320 enhances security and management features such as providing multiple SSID support.

Perfect Solution for Outdoor Environment

The WNAP-7320 is perfectly suitable in outdoor environments and exposed locations. By designing with IP55 and Outdoor UV Stabilized Enclosure, the WNAP-7320 can perform normally under rigorous weather conditions including heavy rain, wind and snow. Moreover, the WNAP-7320 is rated to operate at the temperature from -30 to 75 Degree C; thus it can operate more stably than general outdoor equipments. It is the best way using the WNAP-7320 to build outdoor wireless access applications between buildings on campuses, business, rural areas and etc.

Flexible Deployment with PoE Feature

With the proprietary Power over Ethernet (PoE) design, the WNAP-7320 can be easily applied in the areas where power outlets are not available. It thus reduces the needs of extra cables and dedicated electrical outlets on the wall, ceiling or any other places where are difficult to reach. It enables the wireless LAN deployment becomes more flexible and worries free from the power outlet locations. It is the best way using the WNAP-7320 to build outdoor wireless access applications between buildings on campuses, business, rural areas and etc.

Easy Installation & Management

With user-friendly Web UI and step by step Setup Wizard, the WNAP-7320 is easier to install, even for users who never experience setting up a wireless network. Furthermore, with SNMP-Based management interface, the WNAP-7320 is convenient to be managed and configured remotely.

1.3 Product Features

- **Industrial Compliant Wireless LAN & LAN**
 - Compliant with IEEE 802.11n wireless technology capable of up to 300Mbps data rate
 - Backward compatible with 802.11a standard
 - Equipped with 10/100Mbps RJ-45 Ports for LAN & WAN, Auto MDI/ MDI-X supported
- **Fixed-network Broadband AP**
 - Supported connection types: Dynamic IP / Static IP / PPPoE / PPTP / L2TP / IPSec
 - Supports Virtual Server, DMZ for various networking applications
 - Supports DHCP Server, UPnP, Dynamic DNS
- **RF Interface Characteristics**
 - Built-in 14dBi Dual-Polarization Antenna
 - High Output Power up to 500mW with multiple adjustable transmit power control
- **Outdoor Environmental Characteristics**
 - Outdoor UV Stabilized Enclosure, IP55 Protection Grade
 - Passive Power over Ethernet design
 - Operating Temperature: -30~75 Degree C
- **Multiple Operation & Wireless Mode**
 - Multiple Operation Modes: Bridge, Gateway, WISP
 - Multiple Wireless Modes: AP, Client CPE (WISP), WDS PtP, WDS PtMP, Repeater
 - Supports Dual-SSID allowing users to access different networks through one single AP
 - Supports WMM (Wi-Fi Multimedia)
- **Secure Network Connection**
 - Supports Software Wi-Fi Protected Setup (WPS)
 - Advanced security: 64/128-bit WEP, WPA / WPA2, WPA-PSK / WPA2-PSK (TKIP/AES), and 802.1x Authentication
 - Supports NAT firewall features, with SPI function to protect against DoS attacks
 - Supports IP / Protocol-based access control and MAC Filtering
- **Easy Installation & Management**
 - Web-Based UI and Quick Setup Wizard for easy configuration
 - Remote Management allows configuration from a remote site
 - SNMP-Based management interface
 - System status monitoring includes DHCP Client, System Log

1.4 Product Specification

Product	WNAP-7320 5GHz 300Mbps 802.11a/n Wireless Outdoor Access Point			
Hardware Specifications				
Standard support	IEEE 802.11a/n Wireless LAN IEEE 802.11i Wireless Security IEEE 802.3 10Base-T Ethernet IEEE 802.3u 100Base-TX Ethernet IEEE 802.3x Flow Control			
Memory	32 Mbytes DDR SDRAM 8 Mbytes Flash			
Interface	Wireless IEEE802.11a/n, 2T2R LAN: 1 x 10/100Base-TX, Auto-MDI/MDIX WAN: 1 x 10/100Base-TX, Auto-MDI/MDIX			
Antenna	Built-in 14dBi Dual-Polarization Antenna - Horizontal: 45 degree - Vertical: 60 degree			
Wireless RF Specifications				
Wireless Technology	IEEE 802.11a IEEE 802.11n			
Data Rate	IEEE 802.11a: 54, 48, 36, 24, 18, 12, 9 and 6Mbps IEEE 802.11n (20MHz): up to 150Mbps IEEE 802.11n (40MHz): up to 300Mbps			
Media Access Control	CSMA / CA			
Modulation	Transmission / Emission Type: OFDM Data modulation type: OFDM with BPSK, QPSK, 16-QAM, 64-QAM			
Frequency Band	5.180GHz ~ 5.825GHz			
Operating Channel	5.180GHz	CH36	5.580GHz	CH116
	5.200GHz	CH40	5.600GHz	CH120
	5.220GHz	CH44	5.620GHz	CH124
	5.240GHz	CH48	5.640GHz	CH128
	5.260GHz	CH52	5.660GHz	CH132
	5.280GHz	CH56	5.680GHz	CH136
	5.300GHz	CH60	5.700GHz	CH140
	5.320GHz	CH64	5.745GHz	CH149
	5.500GHz	CH100	5.765GHz	CH153
	5.520GHz	CH104	5.785GHz	CH157
	5.540GHz	CH108	5.805GHz	CH161
	5.560GHz	CH112	5.825GHz	CH165
*The above 24 channels are defined in theory. The actual application will vary depends on the regulation in different regions and countries.				
RF Output Power	IEEE 802.11a: 27 ± 1dBm			

	IEEE 802.11n: 24 ± 1dBm
Receiver Sensitivity	IEEE 802.11a: -92 ~ -73dBm @ 6Mbps ~ 54Mbps IEEE 802.11n: -94 ~ -73dBm @ MCS0 ~ MCS15
Output Power Control	3~27dBm
Software Features	
LAN	Built-in DHCP server supporting static IP address distributing
	Supports 802.1d STP (Spanning Tree)
WAN	<ul style="list-style-type: none"> ■ Static IP ■ Dynamic IP ■ PPPoE ■ PPTP ■ L2TP ■ IPsec
Operating Mode	<ul style="list-style-type: none"> ■ Bridge ■ Gateway ■ WISP
Firewall	NAT firewall with SPI (Stateful Packet Inspection)
	Built-in NAT server supporting Virtual Server and DMZ
	Built-in firewall with Port / IP address / MAC / URL filtering
Wireless Mode	<ul style="list-style-type: none"> ■ AP ■ Client ■ WDS PTP ■ WDS PTMP ■ WDS Repeater (AP+WDS)
Channel Width	20MHz / 40MHz
Wireless Isolation	Enable it to isolate each connected wireless clients from communicating with each other mutually.
Encryption Type	64/128-bits WEP, WPA, WPA-PSK, WPA2, WPA2-PSK, 802.1X
Wireless Security	Provides wireless LAN ACL (Access Control List) filtering
	Wireless MAC address filtering
	Supports WPS (WIFI Protected Setup)
	Enable / Disable SSID Broadcast
Multiple SSID	Up to 2
Max. Wireless Client	40
Max. WDS AP	8
Max. Wired Client	60
WMM	Supports Wi-Fi Multimedia
QoS	Supports Quality of Service for bandwidth control
NTP	Network Time Management
Management	Web UI, DHCP Client, Configuration Backup & Restore, Dynamic DNS, SNMP
Diagnostic tool	System Log, Ping Watchdog
Mechanical & Power	
IP Rate	IP55

Material	Outdoor UV Stabilized Enclosure	
Dimension (W x D x H)	275 x 93 x 45mm	
Weight	336 ± 5g	
Installation	Pole mounting or Wall mounting	
Power Requirements	LAN	24V DC, 0.5A/ Passive PoE Pin 4,5 VDC+ Pin 7,8 VDC-
Power Consumption	7.68W	
Environment & Certification		
Operation Temperature	-30~75 Degree C	
Operating Humidity	10~95% non-condensing	
Regulatory	CE / RoHS	
Accessory		
Standard Accessories	<ul style="list-style-type: none"> ■ 24V DC Passive PoE injector & Power cord x 1 ■ Mounting Tie x 2 ■ Quick Installation Guide x 1 ■ CD (User's Manual, Quick Installation Guide) x 1 	

Chapter 2. Hardware Installation

Please follow the instructions below to connect WNAP-7320 to the existing network devices and your computers.

2.1 Hardware Description

- **Dimension:** 275 x 93 x 45mm (W x D x H)



Figure 2-1 Three-way View

2.1.1 The Side Panel – LED

Side Panel - LED

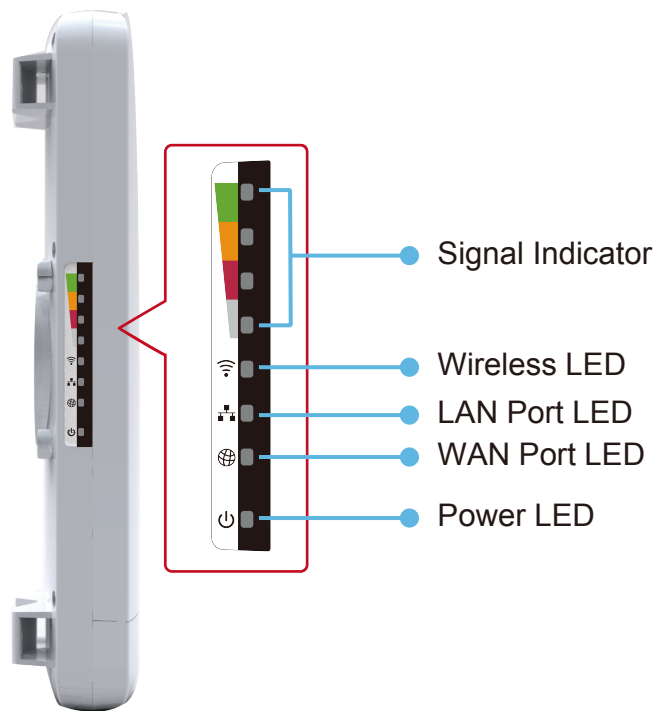

Figure 2-2 LED

LED definition

LED	State	Meaning
Power	On	System On
	Off	System Off
Signal Indicator	On	Indicates the wireless signal strength of remote AP
(Client/Repeater Mode)	Off	No remote wireless signal
Wireless	On	Wi-Fi On
	Off	Wi-Fi Off
WAN Port	On	Port linked.
	Off	No link.
LAN Port	On	Port linked.
	Off	No link.

Table 2-1 The LED indication

2.1.2 The Rear Panel – Mounting Design

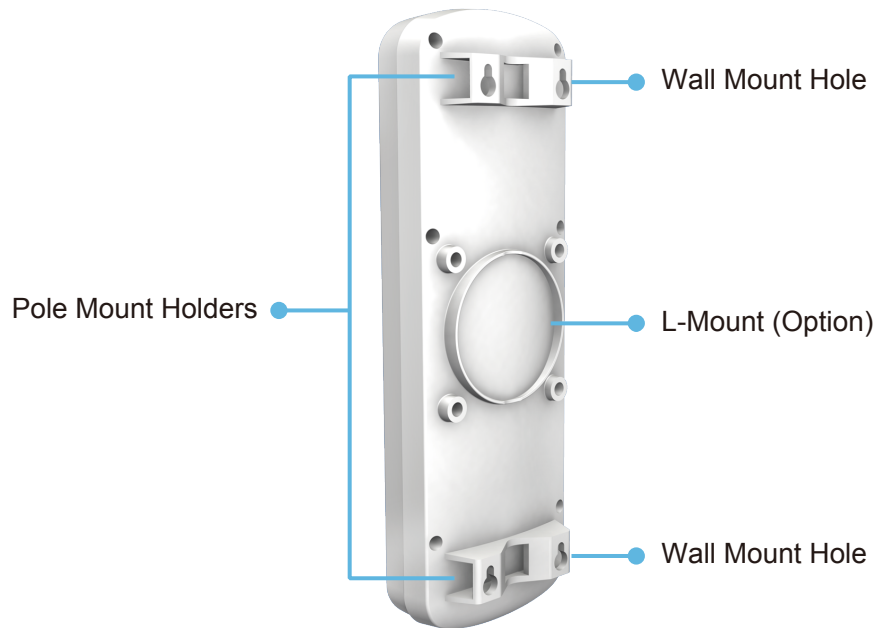

Figure 2-3 Mounting Design

Mounting Design

LED	Meaning
Pole Mount Holders	Use the " Mounting Ties " shipped in the box with the WNAP-7320 for Pole Mounting.
L-Mount (Option)	Use the optional " L-Mount Kit " for Pole Mounting with adjustable angle. The L-Mount-Kit must be purchased separately.
Wall Mount Hole	Use suitable screws for Wall Mounting. The screws did not supply with the WNAP-7320.



Figure 2-4 L-Mount Kit

2.1.3 The Bottom Panel – Port

The Bottom panel provides the physical connectors connected to the power adapter and any other network devices. **Figure 2-5** shows the Bottom panel of WNAP-7320.

Bottom Panel

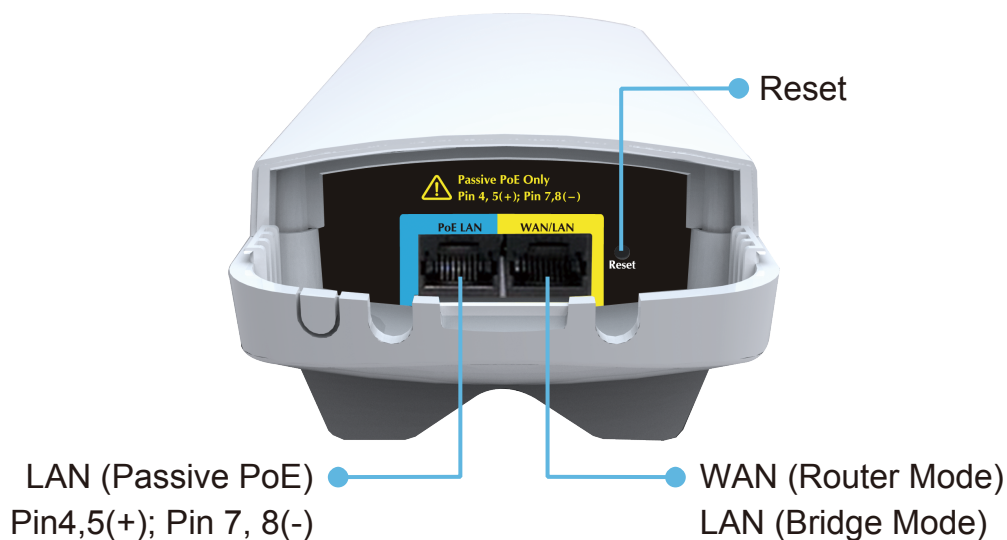

Figure 2-5 Bottom Panel

Interface definition

Interface	Description
LAN (Passive PoE)	10/100Mbps RJ-45 port , Auto MDI/ MDI-X & Passive PoE supported Connect LAN port to the PoE injector to power on the device.
WAN/LAN	10/100Mbps RJ-45 port , Auto MDI/ MDI-X Connect this port to the xDSL modem in router mode. Connect this port to the network equipment in bridge mode.
Reset	Press Reset button over 5 seconds to return factory default setting.

Table 2-2 The Interface indication

Chapter 3. Connecting to the AP

3.1 Preparation before Installation

3.1.1 Professional Installation Required

Please seek assistance from a professional installer who is well trained in the RF installation and knowledgeable in the local regulations.

3.1.2 Safety Precautions

1. To keep you safe and install the hardware properly, please read and follow these safety precautions.
2. If you are installing WNAP-7320 for the first time, for your safety as well as others', please seek assistance from a professional installer who has received safety training on the hazards involved.
3. Keep safety as well as performance in mind when selecting your installation site, especially where there are electric power and phone lines.
4. When installing WNAP-7320, please note the following things:
 - ◆ Do not use a metal ladder;
 - ◆ Do not work on a wet or windy day;
 - ◆ Wear shoes with rubber soles and heels, rubber gloves, long sleeved shirt or jacket.
5. When the system is operational, avoid standing directly in front of it. Strong RF fields are present when the transmitter is on.

3.2 Installation Precautions

- Users **MUST** use a proper and well-installed surge arrestor and grounding kit with WNAP-7320; otherwise, a random lightening could easily cause fatal damage to WNAP-7320. **EMD (Lightning) DAMAGE IS NOT COVERED UNDER WARRANTY.**
- Users **MUST** use the "Power cord & PoE Injector" shipped in the box with the WNAP-7320. Use of other options will cause damage to the WNAP-7320.



OUTDOOR INSTALLATION WARNING

IMPORTANT SAFETY PRECAUTIONS:

LIVES MAY BE AT RISK! Carefully observe these instructions and any special instructions that are included with the equipment you are installing.

CONTACTING POWER LINES CAN BE LETHAL. Make sure no power lines are anywhere where possible contact can be made. Antennas, masts, towers, guy wires or cables may lean or fall and contact these lines. People may be injured or killed if they are touching or holding any part of equipment when it contacts electric lines. Make sure there is NO possibility that equipment or personnel can come in contact directly or indirectly with power lines.



Assume all overhead lines are power lines.

The horizontal distance from a tower, mast or antenna to the nearest power line should be at least twice the total length of the mast/antenna combination. This will ensure that the mast will not contact power if it falls either during installation or later.

TO AVOID FALLING, USE SAFE PROCEDURES WHEN WORKING AT HEIGHTS ABOVE GROUND.

- Select equipment locations that will allow safe, simple equipment installation.
- Don't work alone. A friend or co-worker can save your life if an accident happens.
- Use approved non-conducting ladders and other safety equipment. Make sure all equipment is in good repair.
- If a tower or mast begins falling, don't attempt to catch it. Stand back and let it fall.
- If anything such as a wire or mast does come in contact with a power line, **DON'T TOUCH IT OR ATTEMPT TO MOVE IT.** Instead, save your life by calling the power company.
- Don't attempt to erect antennas or towers on windy days.

MAKE SURE ALL TOWERS AND MASTS ARE SECURELY GROUNDED, AND ELECTRICAL CABLES CONNECTED TO ANTENNAS HAVE LIGHTNING ARRESTORS. This will help prevent fire damage or human injury in case of lightning, static build-up, or short circuit within equipment connected to the antenna.

- The base of the antenna mast or tower must be connected directly to the building protective ground or to one or more approved grounding rods, using 1 OAWG ground wire and corrosion-resistant connectors.
- Refer to the National Electrical Code for grounding details.

IF A PERSON COMES IN CONTACT WITH ELECTRICAL POWER, AND CANNOT MOVE:

- **DON'T TOUCH THAT PERSON, OR YOU MAY BE ELECTROCUTED.**
- Use a non-conductive dry board, stick or rope to push or drag them so they no longer are in contact with electrical power.

Once they are no longer contacting electrical power, administer CPR if you are certified, and make sure that emergency medical aid has been requested.

3.3 Installing the AP

Please install the AP according to the following steps. Don't forget to pull out the power plug and keep your hands dry.

Step 1. Push the latch in the bottom of WNAP-7320 to remove the sliding cover.

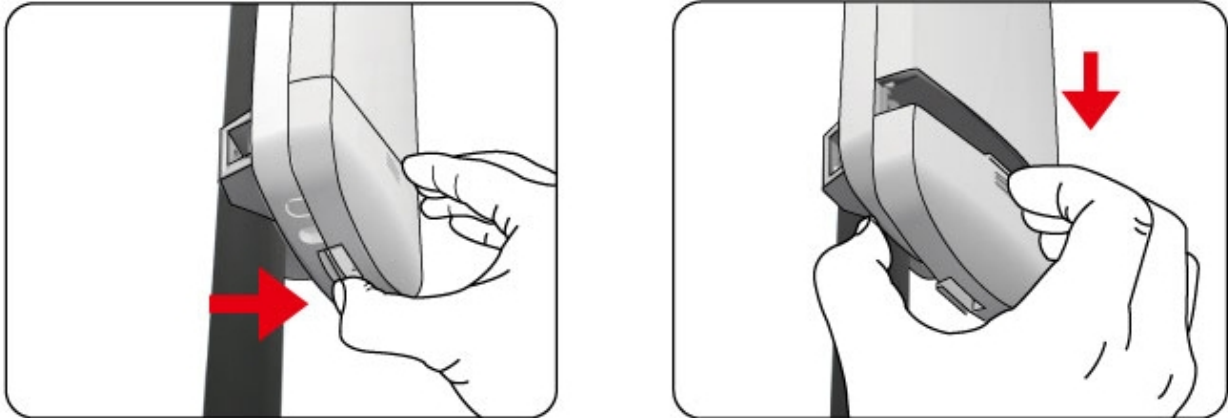

Figure 3-1

Step 2. Plug the RJ-45 Ethernet cable into the PoE LAN Port of WNAP-7320.



Figure 3-2



RJ-45 8P8C Ethernet cable is required.

Step 3. Take out the power cord and PoE injector, plug the power cord into the DC port and plug the other side of the RJ-45 cable in the Step 2 into the POE port of the PoE injector.

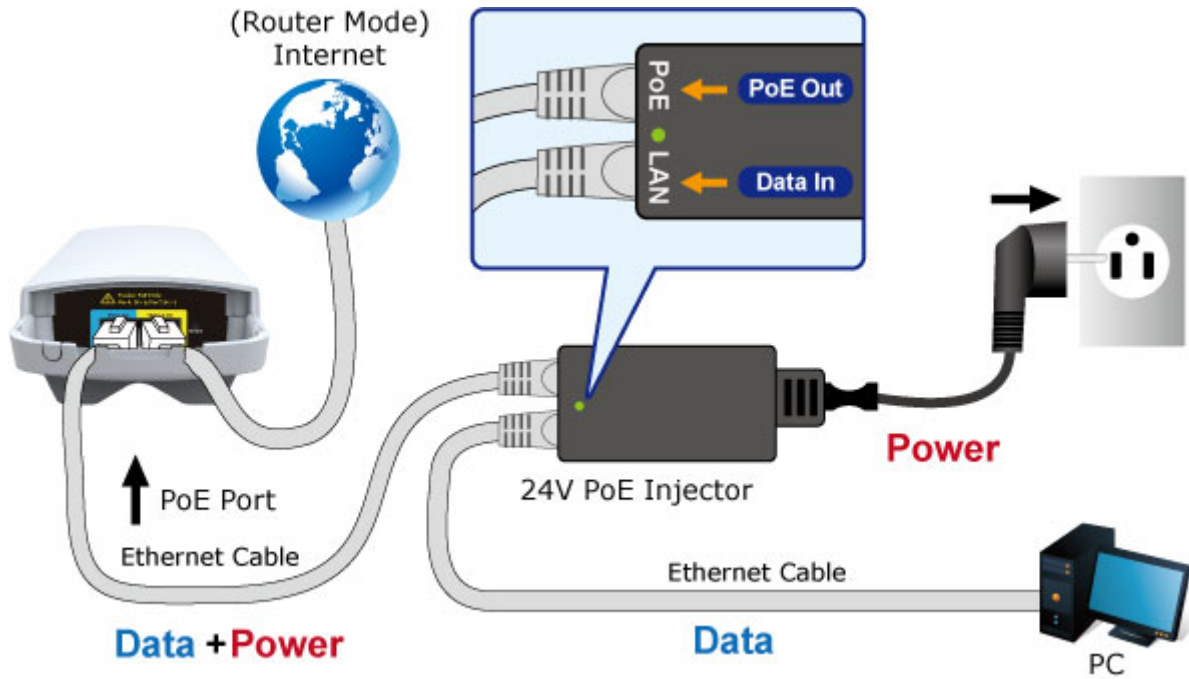

Figure 3-3

Step 4. Slide the cover back to seal the bottom of the WNAP-7320 to finish the installation.

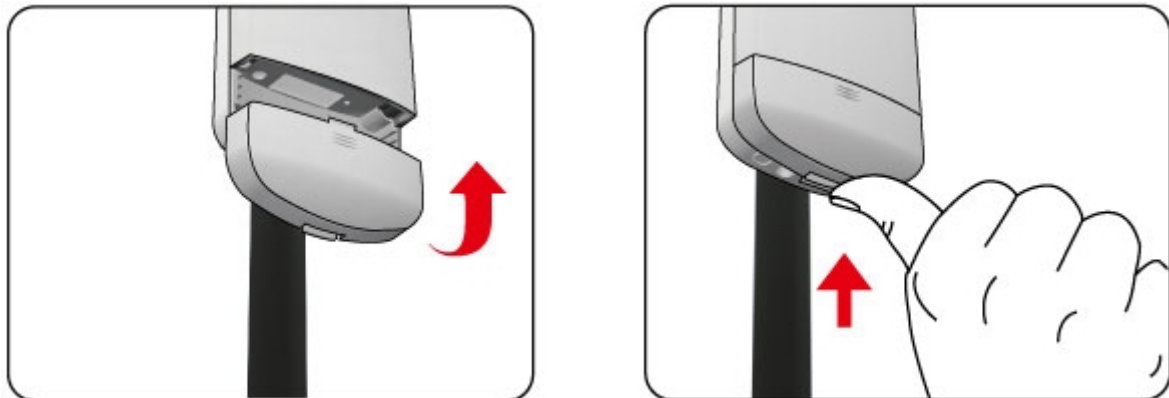

Figure 3-4

3.4 Standard Pole Mounting

Place the straps through the slots on the back of the WNAP-7320 and then around the pole. Tighten the straps to secure the WNAP-7320.

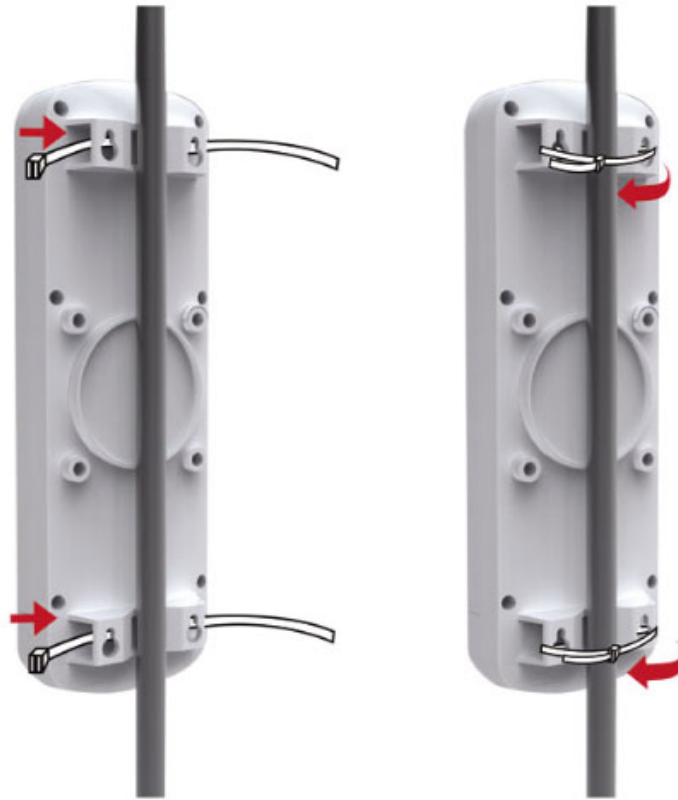

Figure 3-5 Pole Mounting

3.5 Adjustable Pole Mounting

The WNAP-7320 has L-Mount design in the rear panel which provide flexible mounting option for various environments.

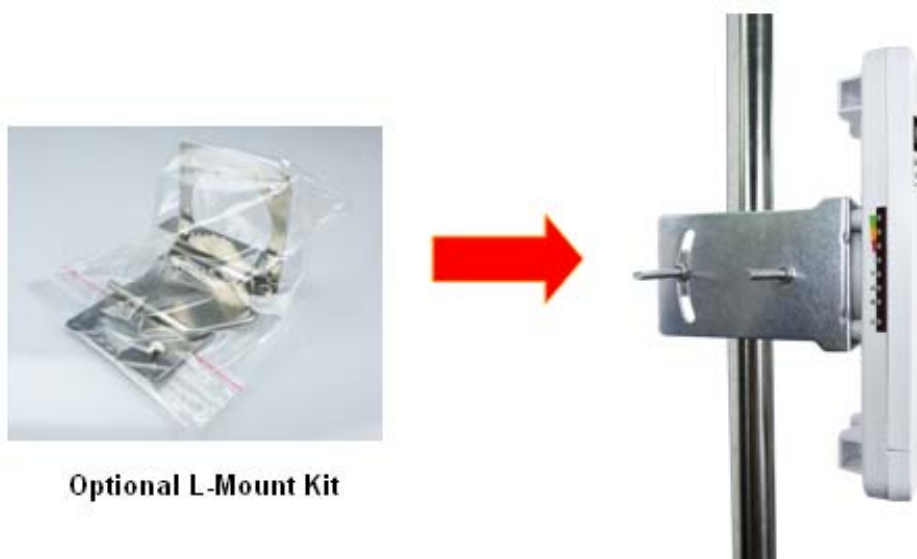

Figure 3-5 L-Mount

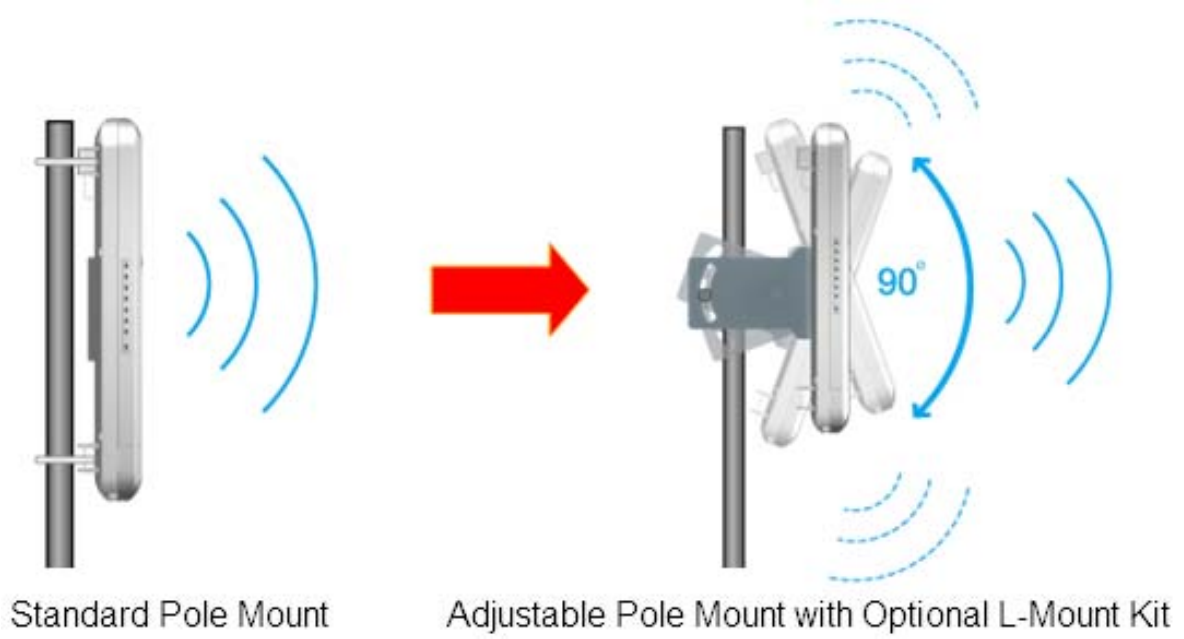

Figure 3-6 L-Mount – Adjustable antenna

3.6 Wall Mounting

There are four Wall Mount Holes in the rear panel of WNAP-7320 which provide wall mounting option for users.

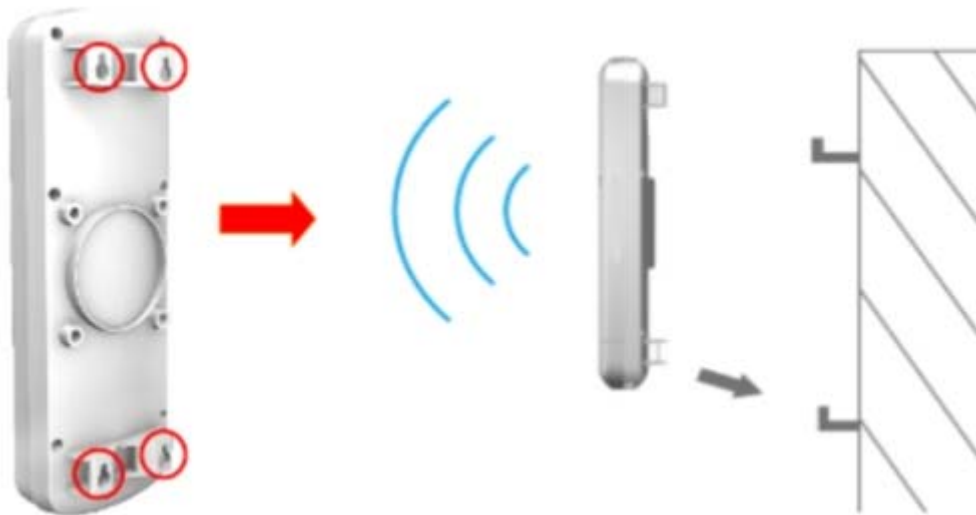

Figure 3-7 Wall Mount

Chapter 4. Quick Installation Guide

This chapter will show you how to configure the basic functions of your Wireless AP using **Easy Setup** within minutes.



A computer with wired Ethernet connection to the Wireless AP is required for the first-time configuration.

4.1 Manual Network Setup - TCP/IP Configuration

The default IP address of the WNAP-7320 is **192.168.1.1**. And the default Subnet Mask is 255.255.255.0. These values can be changed as you desire. In this guide, we use all the default values for description.

Connect the WNAP-7320 with your PC by an Ethernet cable plugging in LAN port of PoE injector in one side and in LAN port of PC in the other side. Please power on the WNAP-7320 by PoE from PoE injector or PoE switch.

In the following sections, we'll introduce how to install and configure the TCP/IP correctly in **Windows XP**. And the procedures in other operating systems are similar. First, make sure your Ethernet Adapter is working, and refer to the Ethernet adapter's manual if needed.

4.1.1 Configure the IP Address Manually

Summary:

- Set up the TCP/IP Protocol for your PC.
- Configure the network parameters. The IP address is 192.168.1.xxx ("xxx" is any number from 2 to 254), Subnet Mask is 255.255.255.0, and Gateway is 192.168.1.1 (The AP's default IP address)

- 1 Select **Use the following IP address** radio button.
- 2 If the AP's LAN IP address is 192.168.1.1, enter IP address 192.168.1.x (x is from 2 to 254), and **Subnet mask** 255.255.255.0.
- 3 Select **Use the following DNS server addresses** radio button. In the **Preferred DNS Server** field, you can enter the DNS server IP address which has been provided by your ISP

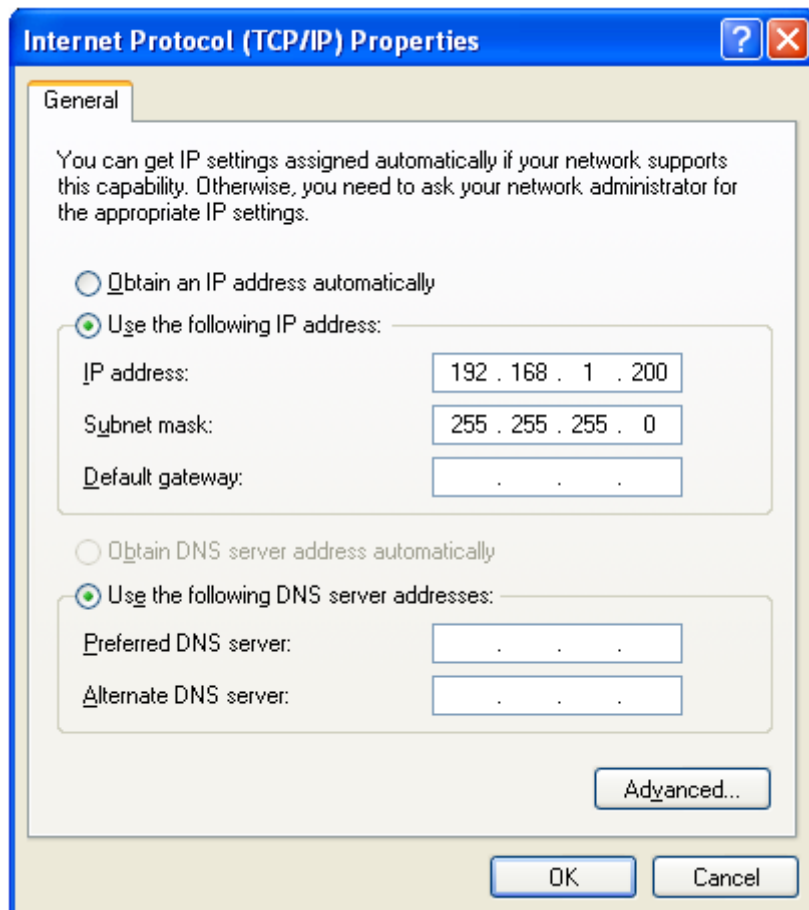

Figure 4-1

Now click **OK** to save your settings.

Now, you can run the Ping command in the **command prompt** to verify the network connection between your PC and the AP. The following example is in **Windows XP OS**. Please follow the steps below:

1. Click on **Start > Run**.



Figure 4-2

2. In the run box type “**cmd**” and click OK. (Windows Vista users type “**cmd**” in the Start .Search box.)At the prompt.

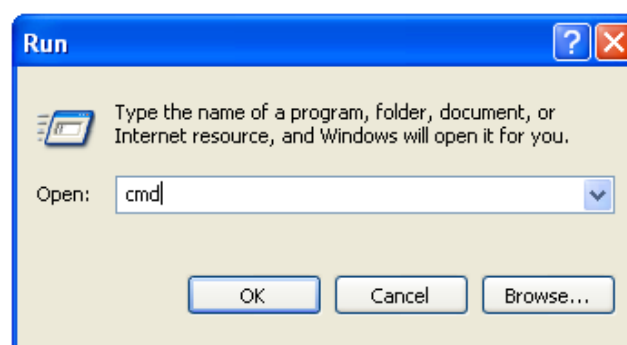
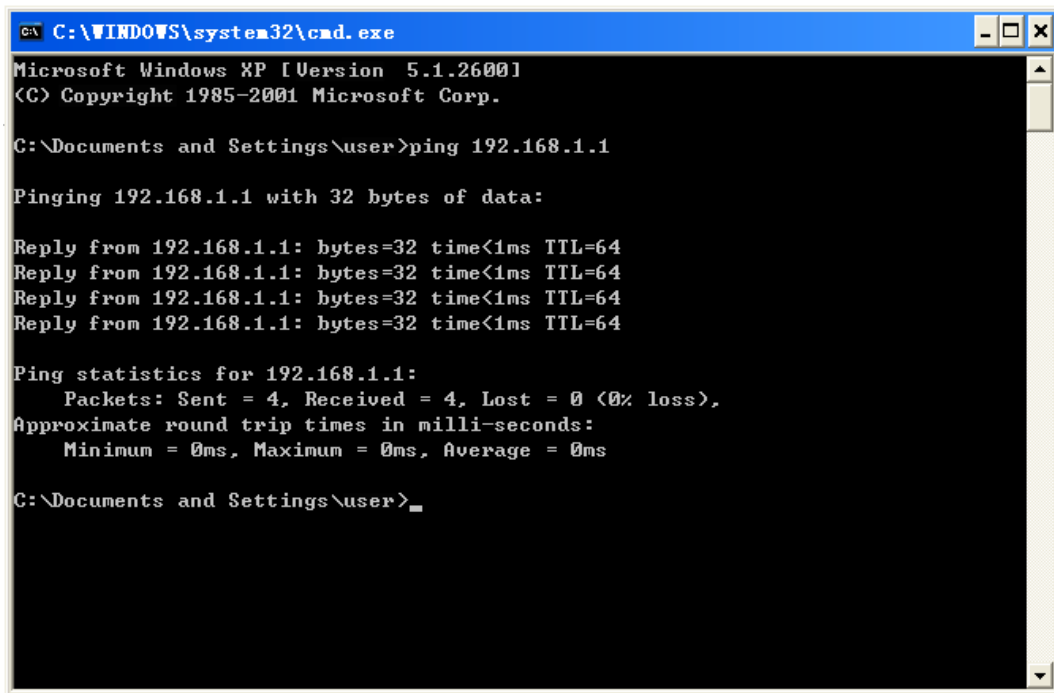

Figure 4-3

Open a command prompt, and type **ping 192.168.1.1**, and then press **Enter**.

If the result displayed is similar to [Figure 4-4](#), it means the connection between your PC and the AP has been established well.



```
C:\WINDOWS\system32\cmd.exe
Microsoft Windows XP [Version 5.1.2600]
(C) Copyright 1985-2001 Microsoft Corp.

C:\Documents and Settings\user>ping 192.168.1.1

Pinging 192.168.1.1 with 32 bytes of data:

Reply from 192.168.1.1: bytes=32 time<1ms TTL=64
Reply from 192.168.1.1: bytes=32 time<1ms TTL=64
Reply from 192.168.1.1: bytes=32 time<1ms TTL=64
Reply from 192.168.1.1: bytes=32 time<1ms TTL=64

Ping statistics for 192.168.1.1:
    Packets: Sent = 4, Received = 4, Lost = 0 (0% loss),
    Approximate round trip times in milli-seconds:
        Minimum = 0ms, Maximum = 0ms, Average = 0ms

C:\Documents and Settings\user>
```

Figure 4-4 Success result of Ping command

If the result displayed is similar to [Figure 4-5](#), it means the connection between your PC and the AP has failed.

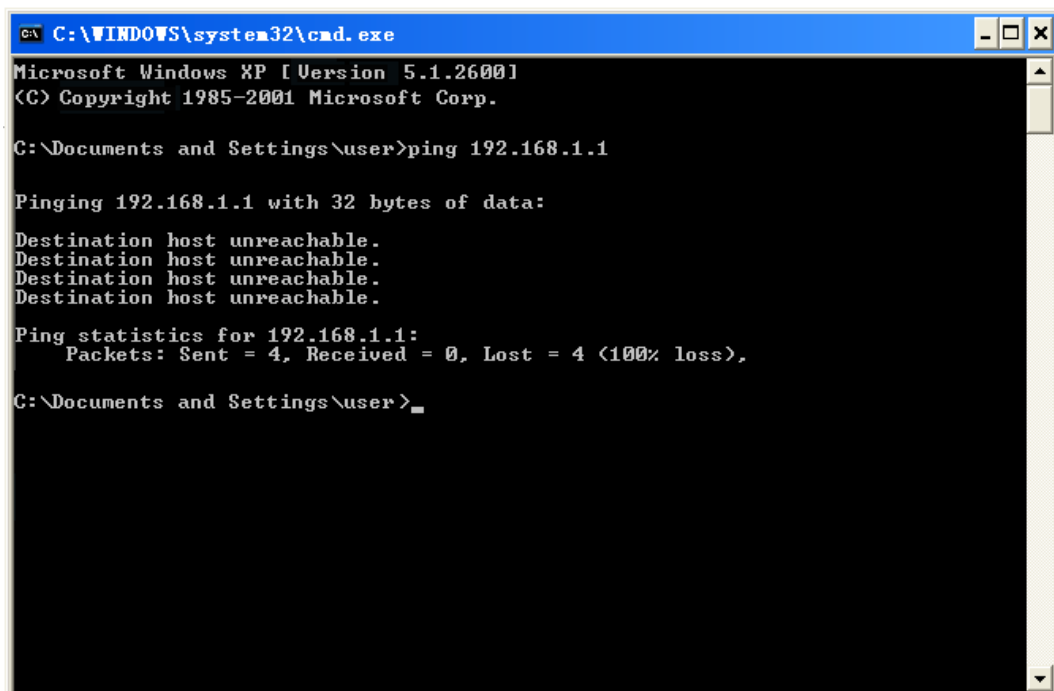

```
C:\WINDOWS\system32\cmd.exe
Microsoft Windows XP [Version 5.1.2600]
(C) Copyright 1985-2001 Microsoft Corp.

C:\Documents and Settings\user>ping 192.168.1.1

Pinging 192.168.1.1 with 32 bytes of data:

Destination host unreachable.
Destination host unreachable.
Destination host unreachable.
Destination host unreachable.

Ping statistics for 192.168.1.1:
    Packets: Sent = 4, Received = 0, Lost = 4 (100% loss),

C:\Documents and Settings\user>
```

Figure 4-5 Failure result of Ping command

If the address is 0.0.0.0, check your adapter installation, security settings, and the settings on your AP. Some firewall software programs may block a DHCP request on newly installed adapters.

4.2 Starting Setup in the Web UI

It is easy to configure and manage the WNAP-7320 with the web browser.

Step 1. To access the configuration page, open a web-browser and enter the default IP address <http://192.168.1.1> in the web address field of the browser.

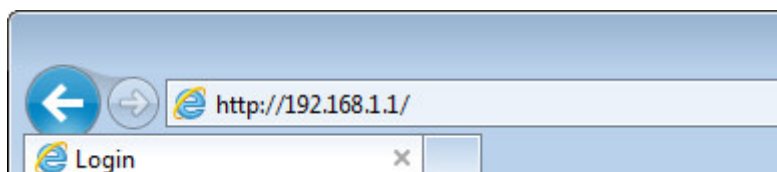

Figure 4-6 Login the AP

After a moment, a login window will appear. Enter **admin** for the User Name and Password, both in lower case letters. Then click the **OK** button or press the **Enter** key.



Figure 4-7 Login Window

Default IP Address: **192.168.1.1**

Default User name: **admin**

Default Password: **admin**



If the above screen does not pop up, it may mean that your web-browser has been set to a proxy. Go to **Tools menu>Internet Options>Connections>LAN Settings**, in the screen that appears, cancel the Using Proxy checkbox, and click OK to finish it.

After entering the username and password, the **Status** page screen appears as [Figure 4-8](#)



Figure 4-8 WNAP-7320 Web UI Screenshot

Step 2. Go to “Easy Setup” to choose an Operation Mode. Please refer to the instructions in the next chapter for configuring the other Operation Modes.

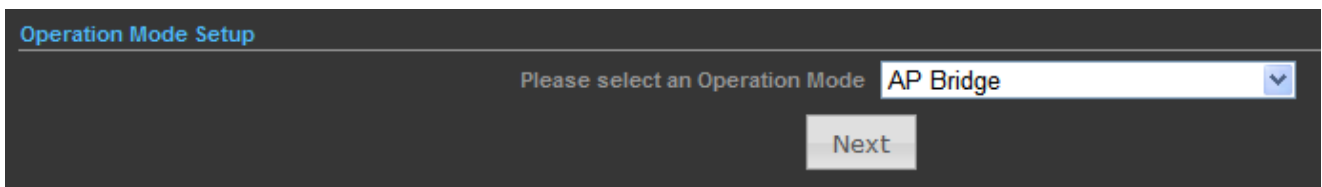

Figure 4-9 Choose Operation Mode

Step 3. Please enter the SSID, configure your Encryption Settings, Pre-Shared Key and etc. Then click **Done** button to make the configuration take effect immediately.

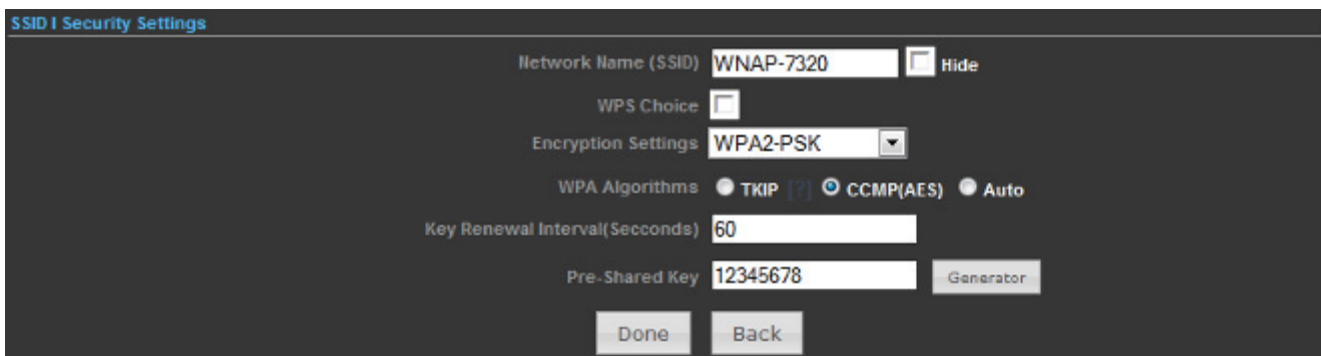

Figure 4-10 Configure Wireless Settings

Chapter 5. Configuring the AP

This chapter delivers a detailed presentation of AP's functionalities and features under 3 main menus (**Status**, **Easy Setup**, and **Advanced**) below, allowing you to manage the AP with ease.



Figure 5-1

5.1 Status

In this page, you can view information about the current running status of WNAP-7320, including WAN interface, LAN interface, Wireless interface, and firmware version information.

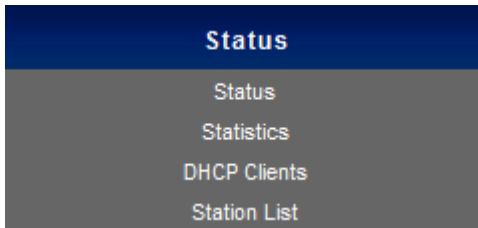

■ Status

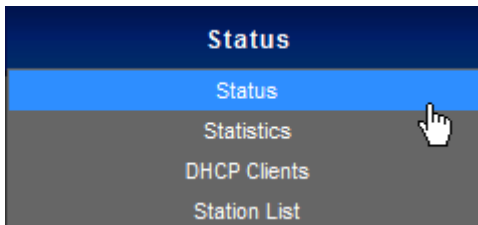

This section allows you to view the AP's System info listed below:

Internet Configuration	
Connected Type DHCP	Connected Status Disconnected/Connecting...
WAN IP Address	Subnet Mask
Default Gateway	Primary Domain Name Server
Secondary Domain Name Server	MAC Address 00:30:4F:60:37:91
LAN Configuration	
LAN IP Address 192.168.1.1	LAN Netmask 255.255.255.0
MAC Address 00:30:4F:60:37:90	
System Info	
Firmware Version V2.6 2012-10-23-15:12	System Time Sun, 01 Jan 2012 12:02:42
Operation Mode AP Router mode	Wireless MAC Address 00:30:4F:60:37:92

Figure 5-1-1

Object	Description
Internet Configuration	
• Connected Type	Displays current Internet connection type.
• Connected Status	<ul style="list-style-type: none"> • Disconnected: Indicates that the Ethernet cable from your ISP side is / is not correctly connected to the WAN port on the AP or the AP is not logically connected to your ISP. • Connecting: Indicates that the WAN port is correctly connected and is requesting an IP address from your ISP. • Connected: Indicates that the AP has been connected to your ISP.
• WAN IP	Displays WAN IP address.
• Subnet Mask	Displays WAN subnet mask.
• Default Gateway	Displays WAN gateway address.
• Primary Domain Name Server	Displays WAN DNS address.
• Secondary Domain Name Server	Displays WAN DNS address.
• MAC Address	Displays AP's WAN MAC address.
LAN Configuration	
• LAN IP Address	Displays LAN IP address.
• LAN Netmask	Displays LAN subnet mask.
• MAC Address	Displays AP's LAN MAC address.
System Info	
• Firmware Version	Displays current F/W version.
• System Time	Displays the System Time.
• Operation Mode	Displays current Operation Mode.
• Wireless MAC Address	Displays AP's Wireless MAC address.

■ Statistics

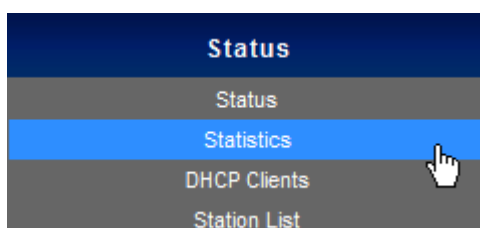

This section allows you to view the AP's Statistics listed below:

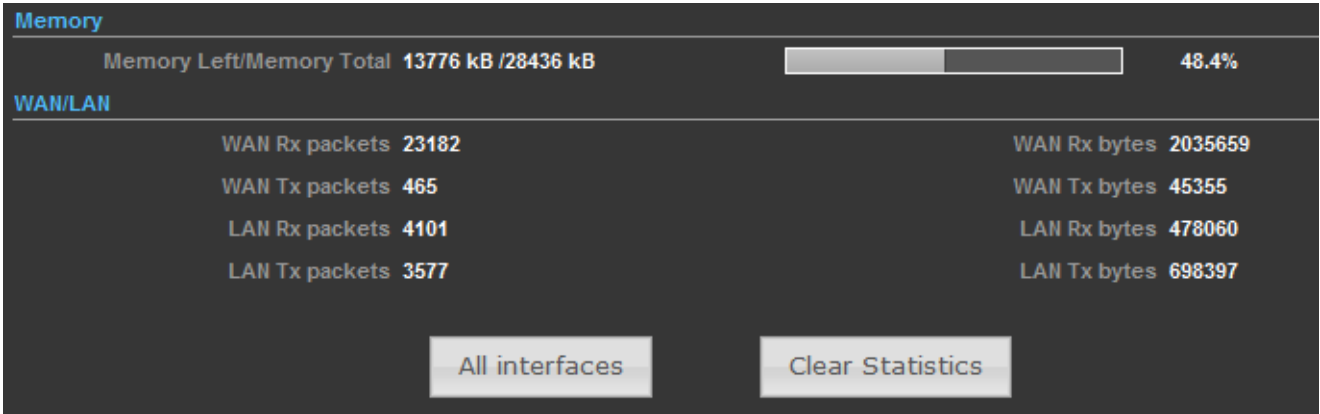
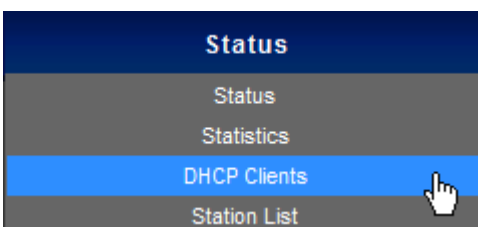

Figure 5-1-2

Object	Description
Memory	
• Memory Left/ Memory Total	Displays the retain memory and total memory.
WAN/LAN	
• WAN Rx packets	Displays the real-time packets received from WAN port.
• WAN Rx bytes	Displays the real-time bytes received from WAN port.
• WAN Tx packets	Displays the real-time packets transmitted from WAN port.
• WAN Tx bytes	Displays the real-time bytes transmitted from WAN port.
• LAN Rx packets	Displays the real-time packets received from LAN port.
• LAN Rx bytes	Displays the real-time bytes received from LAN port.
• LAN Tx packets	Displays the real-time packets transmitted from LAN port.
• LAN Tx bytes	Displays the real-time bytes transmitted from LAN port.

■ DHCP Clients



This section displays a DHCP dynamic client list, which includes MAC address, IP address, and lease time info.

DHCP Clients		
MAC Address	IP Address	Expires in
00:26:66:46:cb:cf	192.168.1.195	23:27:35

Refresh

Figure 5-1-3

Object	Description
• MAC address	Displays MAC address of a given host.
• IP Address	Displays IP address(es) that client(s) obtained from the DHCP server.
• Expires in	Remaining time for a corresponding IP address lease.

■ Station List

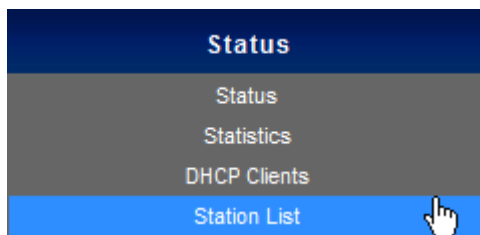

This section allows you to view the Station List. The Station List submenu is only available in AP mode.

Station List (WNAP-7320)			
MAC Address	Rate	RSSI	
00:30:4f:60:ef:ae	0M	73	

Refresh

Figure 5-1-4

Object	Description
• MAC address	Displays MAC address of a connected client.
• Rate	Displays connection speed of a connected client.
• Expires in	Displays the signal strength of a connected client.

5.2 Easy Setup

The Easy Setup helps you configure the basic functions of your Wireless AP within minutes.

Please refer to the Step 2 in the section “[4.2 Starting Setup in the Web UI](#)” for the detail procedure.

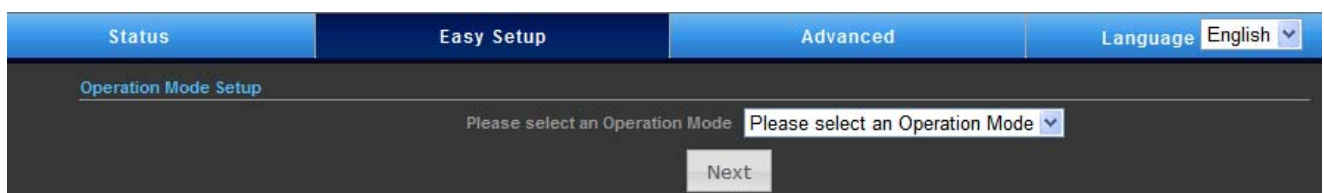

Figure 5-2-1

5.3 Advanced

“Advanced” includes the following four submenus (Advanced, Firewall Settings, Network Settings, and Wireless Settings). Clicking any of them enters corresponding interface for configuration. Below explains, in details, each such feature.

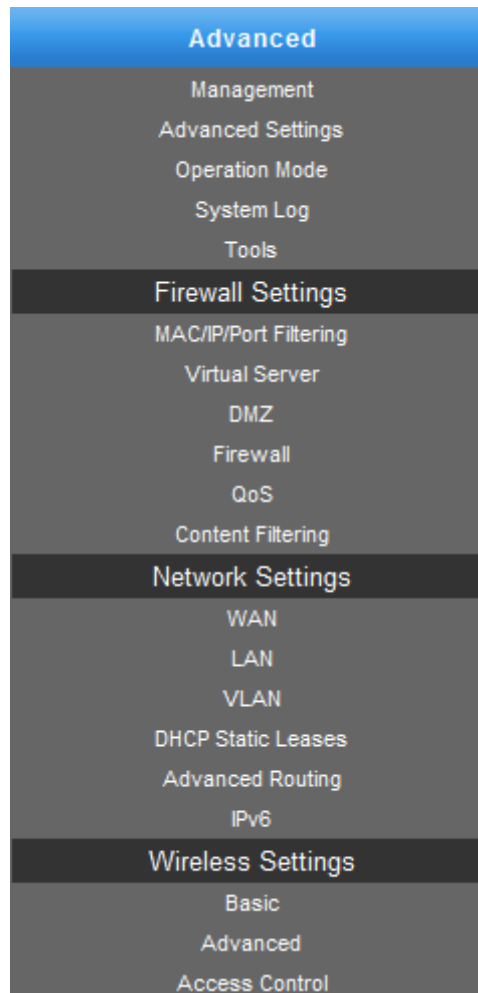
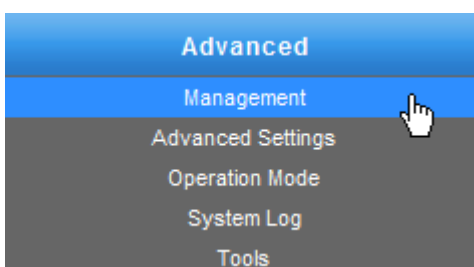

Figure 5-3-1

5.3.1 Advanced - Management



This section allows you to manage the Wireless AP.

5.3.1.1. Web Interface Settings (Password)

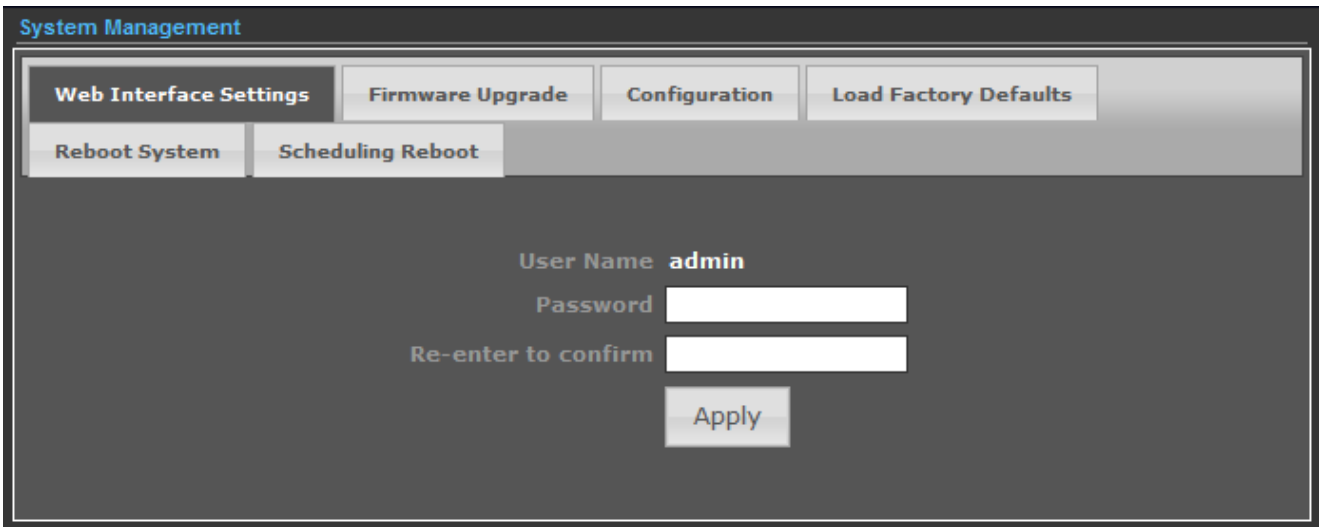

Figure 5-3-2

Object	Description
• User Name	Display the User Name info.
• Password	Enter the new password that you prefer for login.
• Re-enter to confirm	Re-enter the new password to confirm.



If you changed the login password, you must enter the new one in the next login.

5.3.1.2. Firmware Upgrade

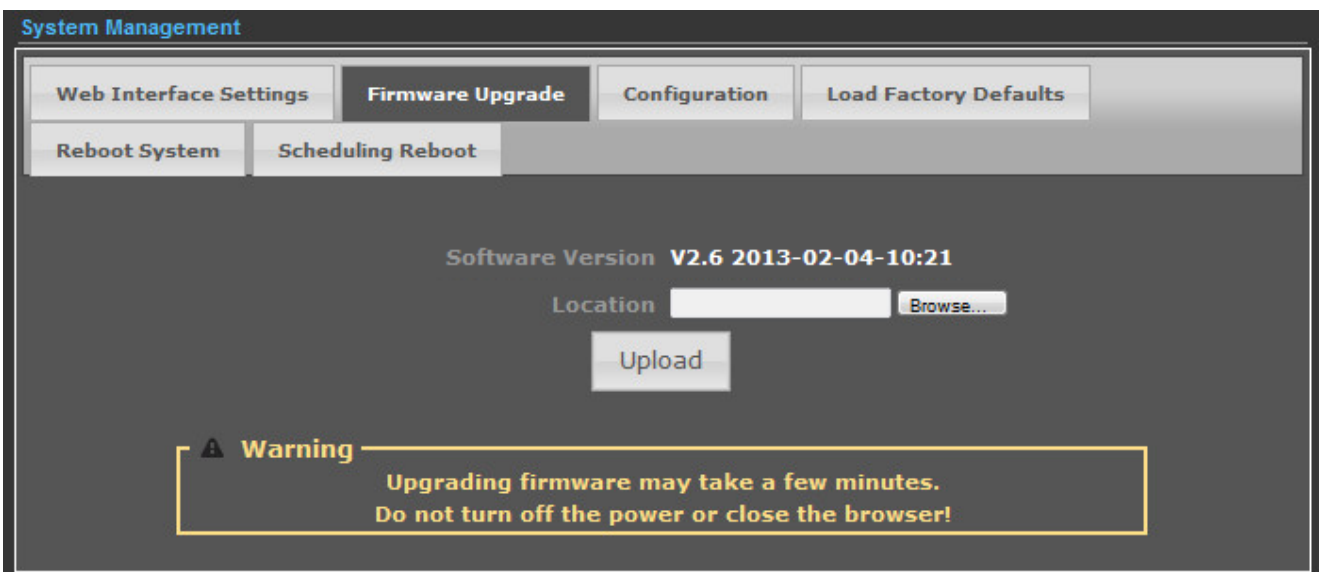



Figure 5-3-3

Click the “Browse...” button to select the new firmware for upgrading.

Object	Description
• Software Version	Display the current Software Version info.
• Location	Click the “Browse...” button to select the new firmware in this field.
• Upload	Click the “Upload” button to upgrade the new firmware.

	<p>IMPORTANT SAFETY PRECAUTIONS:</p> <p>Do Not Turn off the power or close the browser during upgrade process!</p>
---	---

5.3.1.3. Configuration

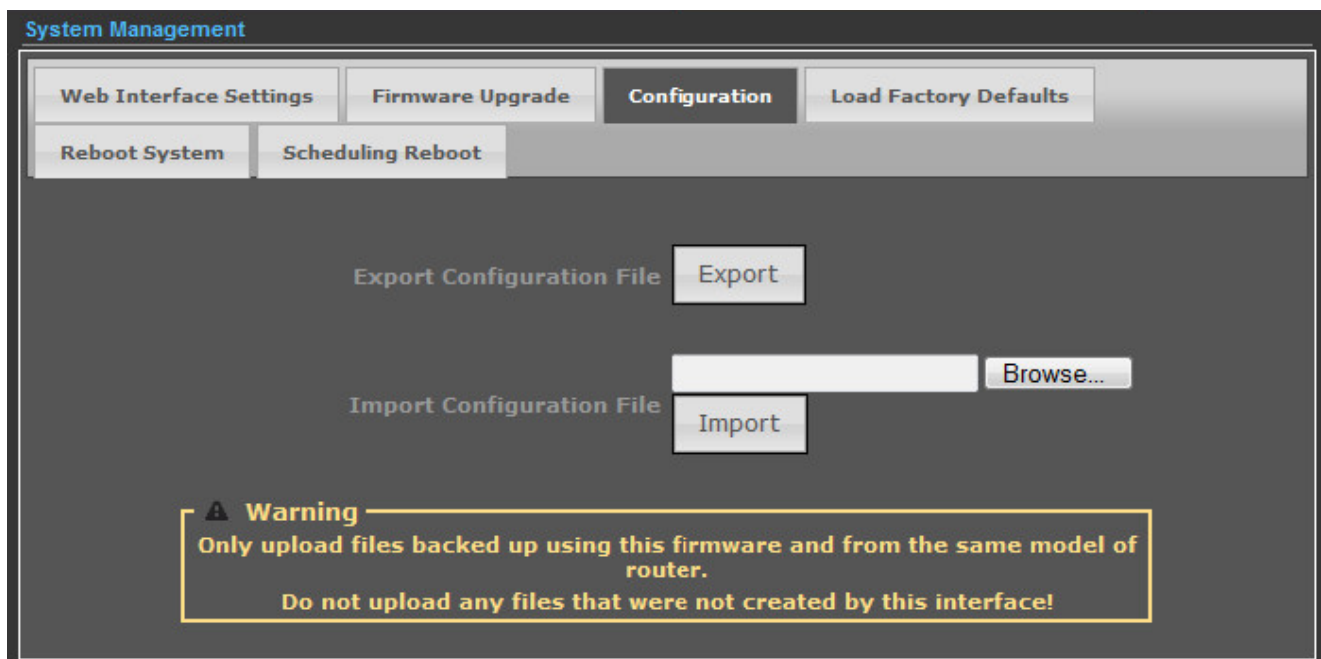

Figure 5-3-4

Click the “Export” button to backup the configuration of the Wireless AP, and click “Import” to restore the configuration.

Object	Description
• Export	Click the “Export” button to backup the configuration.
• Browse...	Click the “Browse...” button to select the configuration file in this field for restoring settings.
• Import	Click the “Import” button to restore the configuration.

5.3.1.4. Load Factory Defaults

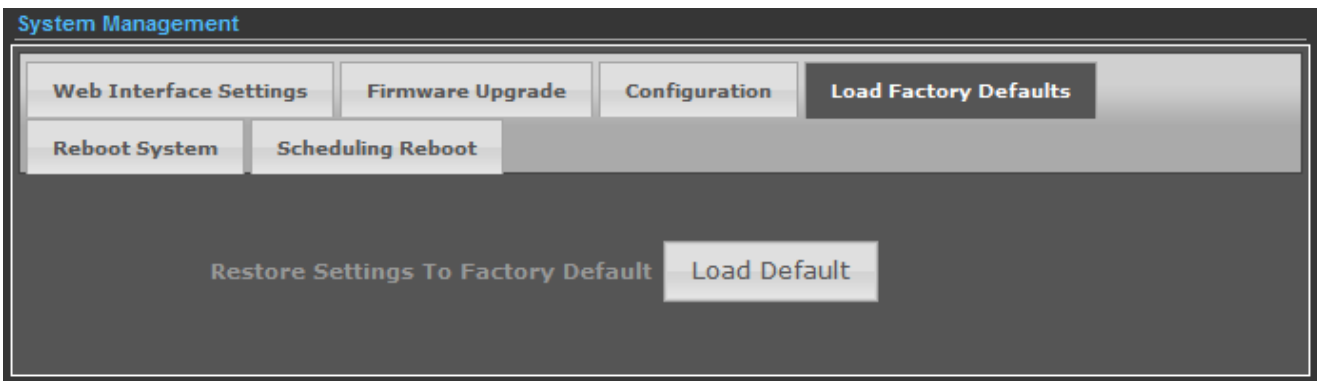

Figure 5-3-5

Click the “**Load Default**” button to reset it to factory default settings.

5.3.1.5. Reboot System

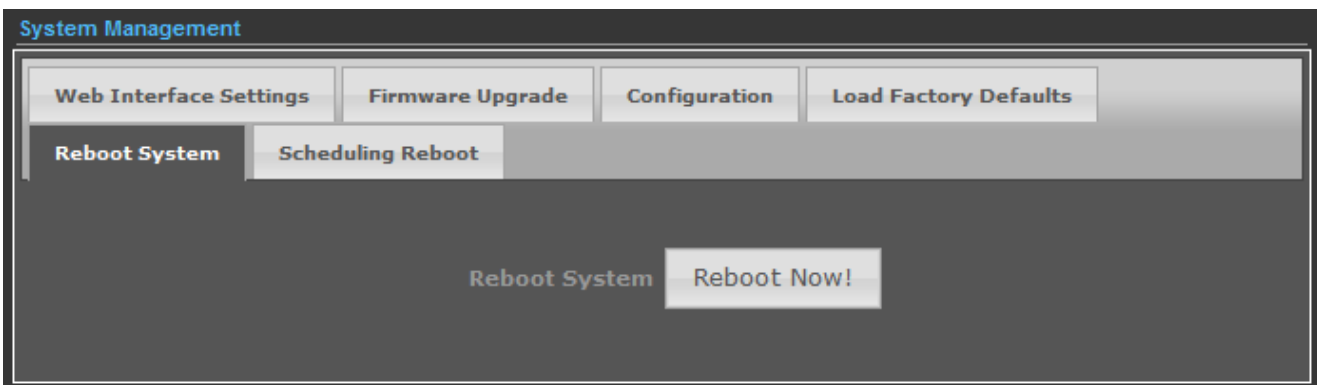

Figure 5-3-6

Click the “**Reboot Now!**” button to restart the Wireless AP.

5.3.1.6. Scheduling Reboot

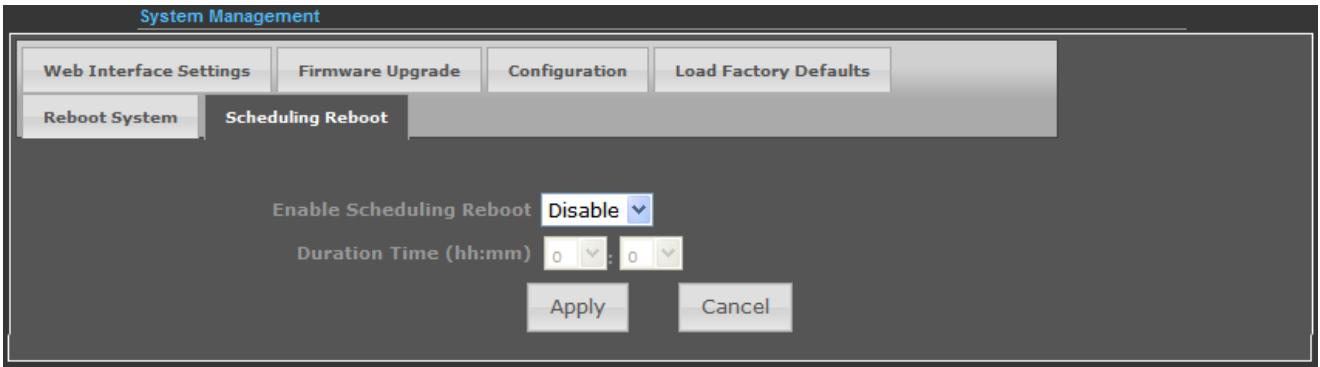
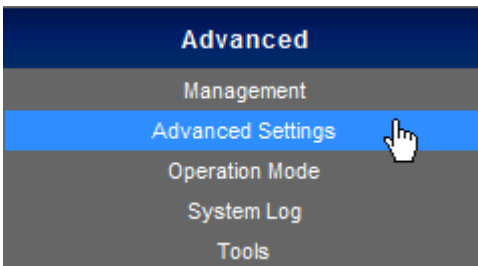

Figure 5-3-7

Select “**Enable**” to configure the system auto reboot according to the Duration Time (Time interval).

Object	Description
<ul style="list-style-type: none"> • Enable Scheduling Reboot 	<p>Enable: select it to enable the Scheduling Reboot.</p> <p>Disable: select it to disable the Scheduling Reboot.</p>
<ul style="list-style-type: none"> • Duration Time (hh:mm) 	<p>Configure the particular time interval for the system auto reboot.</p> <p>hh: means hours</p> <p>mm: means minutes</p>

5.3.2 Advanced – Advanced Settings



This section allows you to configure advanced settings of the Wireless AP.

5.3.2.1. Time Zone Settings

The screenshot shows the 'Time Zone Settings' page. At the top, there are tabs for 'Time Zone Settings', 'DDNS Settings', 'UPNP Settings', and 'SNMP Settings'. The 'Time Zone Settings' tab is active. Below the tabs, there are several fields: 'Current Time' with a text box containing 'Sun, 01 Jan 2012 14:50' and a 'Sync with host' button; 'Time Zone' with a dropdown menu showing 'Please select your Time Zone settings.'; 'SNTP Server' with a text box containing '?' and a help icon; and 'SNTP synchronization (minutes)' with a text box. At the bottom, there are 'Apply' and 'Cancel' buttons.

Figure 5-3-8

The page includes the following fields:

Object	Description
• Current Time	Display the current Time.
• Sync with host	Click it to sync your PC's time to the device.
• Time Zone	Select your current time zone.
• SNTP Server	Configure your SNTP Server.
• SNTP Synchronization (minutes)	Determines a time length when device periodically updates its time and date info from Internet.

5.3.2.2. DDNS Settings

The screenshot shows the 'DDNS Settings' page. At the top, there are tabs for 'Time Zone Settings', 'DDNS Settings', 'UPNP Settings', and 'SNMP Settings'. The 'DDNS Settings' tab is active. Below the tabs, there are several fields: 'Dynamic DNS Provider' with a dropdown menu showing 'None'; 'HostName' with a text box; 'User Name' with a text box; and 'Password' with a text box. At the bottom, there are 'Apply' and 'Cancel' buttons.

Figure 5-3-9

The page includes the following fields:

Object	Description
--------	-------------

• Dynamic DNS Provider	Select your Dynamic DNS Provider.
• Host Name	Enter the host name or domain name provided by your DDNS service provider.
• User Name	Enter the name of your DDNS account.
• Password	Password: Enter the password of the DDNS account.

Example of Planet DDNS Settings:



Please go to <http://www.planetddns.com/> to register a Planet DDNS account.

Please refer to the FAQ (<http://www.planetddns.com/index.php/faq>) for how to register a free account.

Please refer to the procedure listed as following to configure using Planet DDNS service.

Step 1. Select “**Enable Dynamic DDNS**” and “**planetddns.com**” from the list of Dynamic DNS Provider to use the Planet DDNS service.

Step 2. Configure the DDNS account that has been registered in Planet DDNS website.

Host Name: Enter your DDNS host (format: xxx.planetddns.com, xxx is the registered domain name)

User Name: Enter your DDNS account

Password: Enter your DDNS account’s password

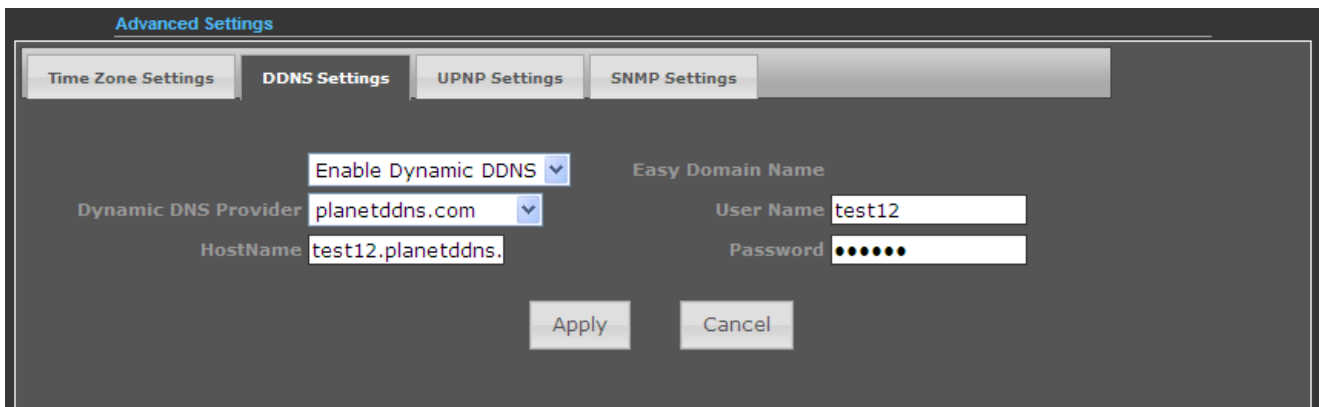

Figure 5-3-10

Step 3. Go to “**Advanced-> Firewall Settings-> Firewall**” to allow remote access from WAN port.

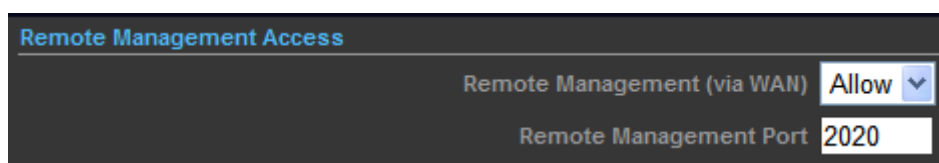

Figure 5-3-11

Step 4. Go to “Advanced-> Network Settings-> WAN” to configure WAN Connection using Static (Fixed IP).

Wide Area Network (WAN) Settings

WAN Connections: Static (Fixed IP)

Static Mode

IP Address: 210.66.155.70

Subnet Mask: 255.255.255.0

Default Gateway: 210.66.155.94

DNS Settings

Primary DNS Server: 8.8.8.8

Secondary DNS Server: 168.95.1.1

Apply Cancel

Figure 5-3-12

Step 5. Apply the settings, and connect your WAN port of the Wireless AP to the internet by Ethernet cable.

Step 6. In a remote computer, enter the DDNS host name as the figure shown as below. Then, you should be able to login the WNAP-7320 remotely.

Please remember to enter the remote management port number that you have configured in Step 3.

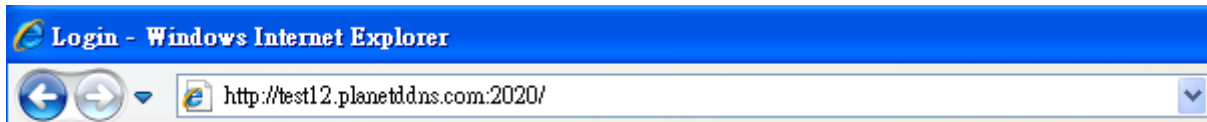

Figure 5-3-13

You can go to **My Devices** page of Planet DDNS website to check if the “**Last Connection IP**” is displayed. This indicates your DDNS service is work properly.

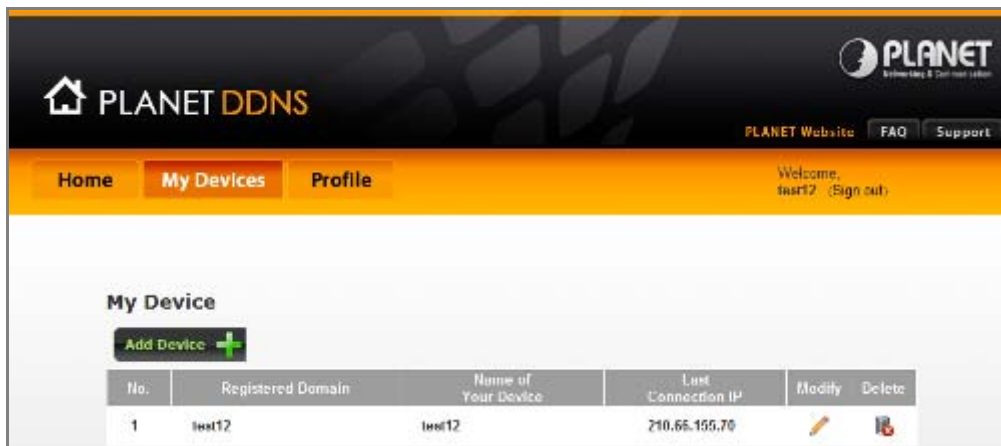

Figure 5-3-14

Example of Easy DDNS Settings:



This service is not required to register any DDNS account.

Please refer to the procedure listed as following to configure using Planet Easy DDNS service.

Step 1. Select “Enable Easy DDNS” to use the Planet Easy DDNS service.

Easy Domain Name: Display the specified domain name for this device. (format: [plxxxxxx.planetddns.com](#), xxxxxx is the last six-digit of the WAN Port MAC address)

The screenshot shows the 'Advanced Settings' window with the 'DDNS Settings' tab selected. The 'Enable Easy DDNS' dropdown menu is open and set to 'Enable Easy DDNS'. Below it, the 'Dynamic DNS Provider' is set to 'planetddns.com'. The 'Easy Domain Name' field contains 'pl66E689.planetddns.com'. There are also input fields for 'User Name' and 'Password', and 'Apply' and 'Cancel' buttons at the bottom.

Figure 5-3-15

Step 2. Go to “Advanced-> Firewall Settings-> Firewall” to allow remote access from WAN port.

The screenshot shows the 'Remote Management Access' settings. The 'Remote Management (via WAN)' dropdown menu is set to 'Allow'. The 'Remote Management Port' is set to '2020'.

Figure 5-3-16

Step 3. Go to “Advanced-> Network Settings-> WAN” to configure WAN Connection using Static (Fixed IP).

The screenshot shows the 'Wide Area Network (WAN) Settings' page. The 'WAN Connections' dropdown is set to 'Static (Fixed IP)'. Under 'Static Mode', the IP Address is 210.66.155.70, Subnet Mask is 255.255.255.0, and Default Gateway is 210.66.155.94. Under 'DNS Settings', the Primary DNS Server is 8.8.8.8 and the Secondary DNS Server is 168.95.1.1. There are 'Apply' and 'Cancel' buttons at the bottom.

Figure 5-3-17

Step 4. Apply the settings, and connect your WAN port of the Wireless AP to the internet by Ethernet cable.

Step 5. In a remote computer, enter the Easy Domain Name displayed in the [Step 1](#). Then, you should be able to login the WNAP-7320 remotely.

Please remember to enter the remote management port number that you have configured in [Step 3](#).

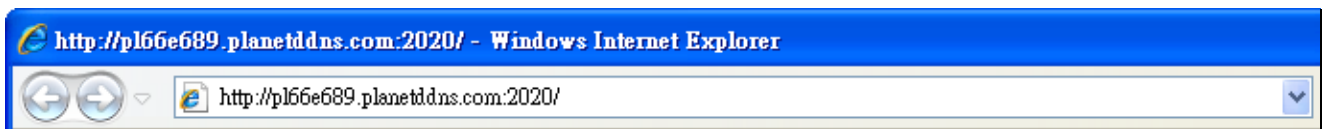

Figure 5-3-18

5.3.2.3. UPNP Settings

Select “Enable” to enable the UPNP function.

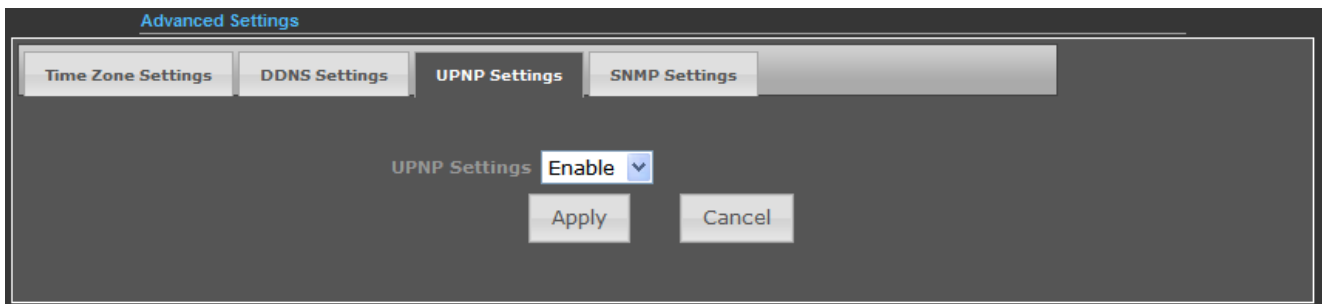

Figure 5-3-19

In the computer connected with WNAP-7320, go to “Network” to check the WNAP-7320 is displayed in the list. Double-click it to logon the Web UI of WNAP-7320.

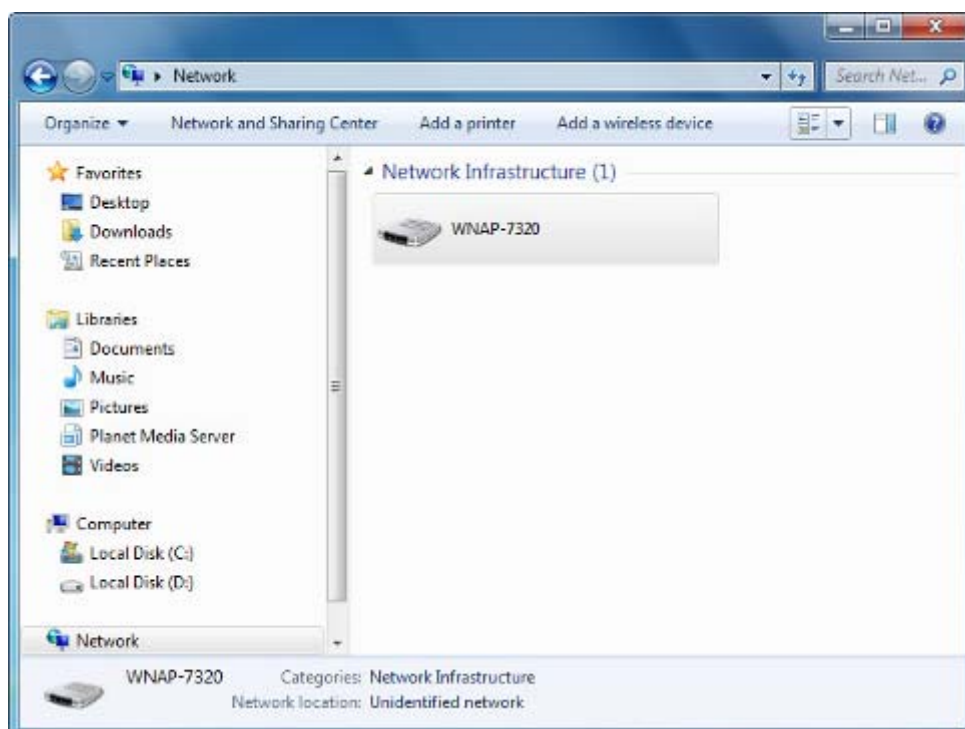

Figure 5-3-20

5.3.2.4. SNMP Settings

Enable **SNMP** function will allow the network management station to retrieve statistics and status from the SNMP Agent in the device.

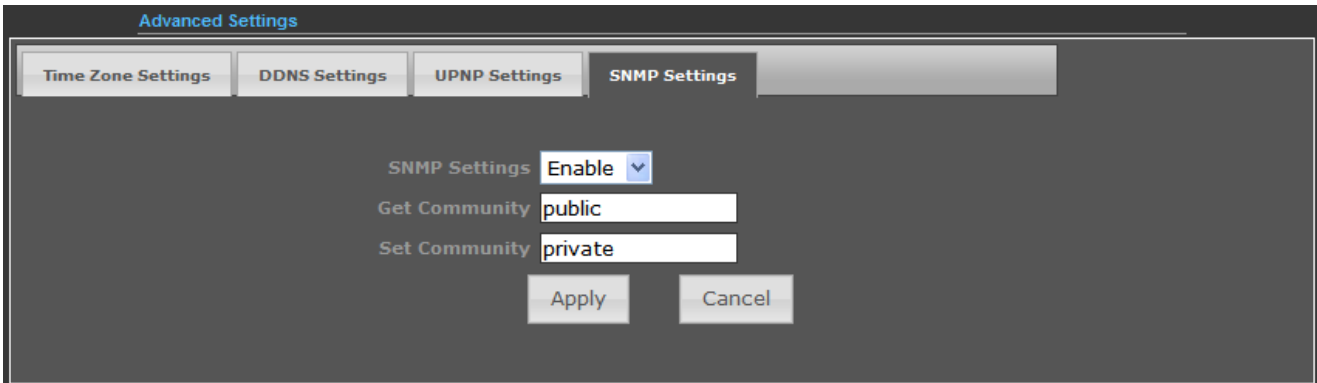
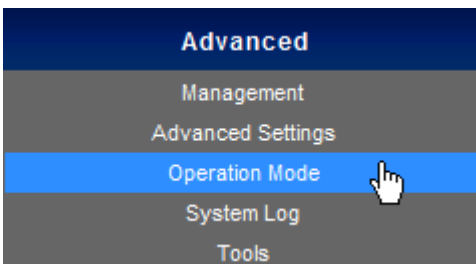

Figure 5-3-21

The page includes the following fields:

Object	Description
<ul style="list-style-type: none"> • SNMP Settings 	Choose Enable to open this function if you want to have remote control through SNMPv1/v2 agent. Choose Disable to close this function.
<ul style="list-style-type: none"> • Get Community 	Enter the community name that allows Read-Only access to the Device's SNMP information. The community name can be considered a group password. The default setting is public.
<ul style="list-style-type: none"> • Set Community 	Enter the community name that allows Read/Write access to the Device's SNMP information. The community name can be considered a group password. The default setting is private.

5.3.3 Advanced – Operation Mode



There are 4 operation modes (**AP Router**, **AP Bridge**, **Client Router**, **Client Bridge**) can be configured to meet various applications.

5.3.3.1. AP Router (AP+Router)

In the Access Point Mode with Router Function, **WNAP-7320** acts as central connection point, which wireless clients can connect to. The DHCP & NAT is enabled, so the clients wirelessly connected to WNAP-7320 can share the internet connection by connecting WNAP-7320 to a DSL/Cable modem.

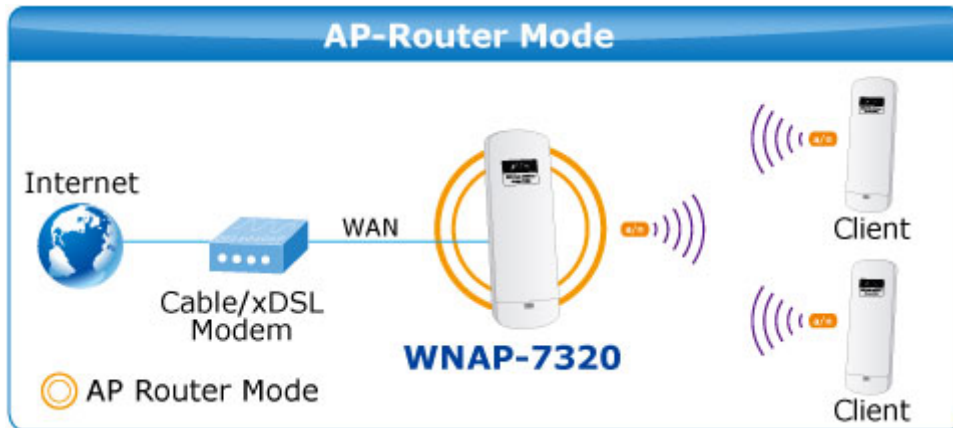

1. Connect the LAN port of WNAP-7320 to the POE port of the PoE Injector with an Ethernet cable.
2. Connect the DSL/Cable Modem to the WAN port of the WNAP-7320.
3. Plug one end of the power cord into the PoE Injector, and the other end in electrical socket.
4. Go to “**Advanced-> Operation Mode**” to configure it to **AP Router Mode**.

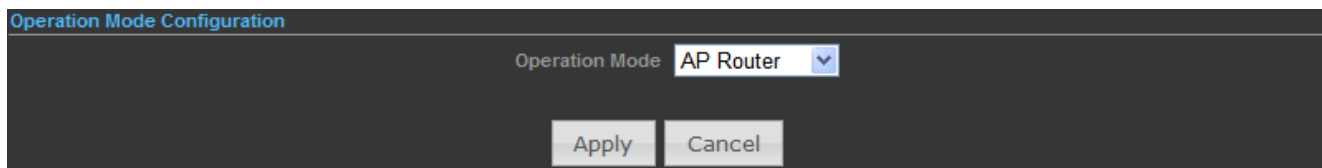

Figure 5-3-22



In this mode, the LAN2 of the WNAP-7320 works as the WAN port.

To configure the Wireless Settings of AP Router Mode, please refer to the section [5.6 Wireless Settings](#).

5.3.3.2. AP Bridge (AP+WDS)

In the Access Point Mode with WDS Function, **WNAP-7320** function likes a central connection for any stations or clients. Stations and Client must configure the same SSID and Security Password to associate within the range. WNAP-7320 supports 2 different SSIDs to separate different clients at the same time.



1. Connect the LAN port of WNAP-7320 to the POE port of the PoE Injector with an Ethernet cable.
2. Connect the PC to the LAN port of the PoE Injector with an Ethernet cable.
3. Plug one end of the power cord into the PoE Injector, and the other end in electrical socket.
4. Go to “**Advanced-> Operation Mode**” to configure it to **AP Bridge Mode**.

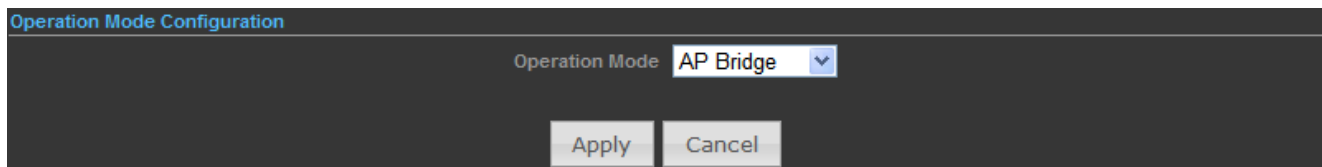

Figure 5-3-23



Note

In this mode, the Wireless interface of the WNAP-7320 works as the WAN port.

To configure the Wireless Settings of AP Bridge Mode, please refer to the section [5.6 Wireless Settings](#).

5.3.3.3. Client Router (WISP)

In the Client Router Mode, the WNAP-7320 has DHCP Server build inside that allows many LANs automatically generate an IP address to share the same Internet. Connect an AP/WISP Wirelessly and connect to LANs via wired. Client Router Mode is act completely opposite to the AP Router Mode.

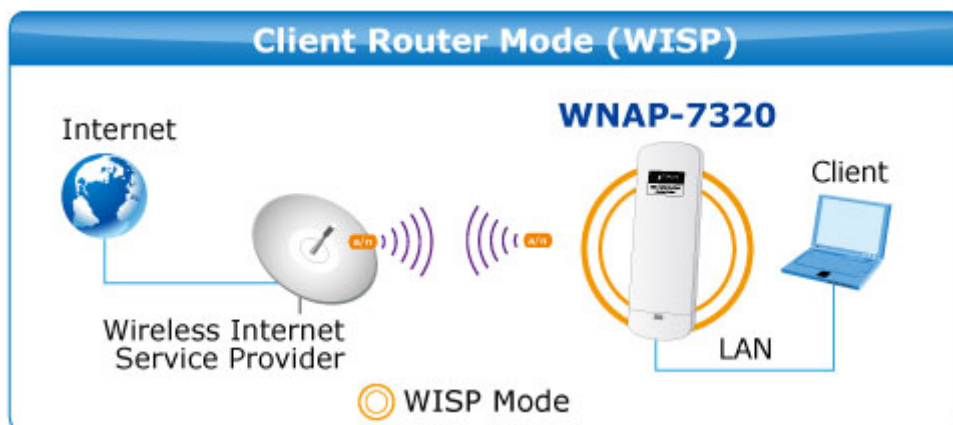

1. Connect the LAN port of WNAP-7320 to the POE port of the PoE Injector with an Ethernet cable.
2. Connect the PC to the LAN port of the PoE Injector with an Ethernet cable.
3. Plug one end of the power cord into the PoE Injector, and the other end in electrical socket.
4. Go to “**Advanced-> Operation Mode**” to configure it to **Client Router** Mode.

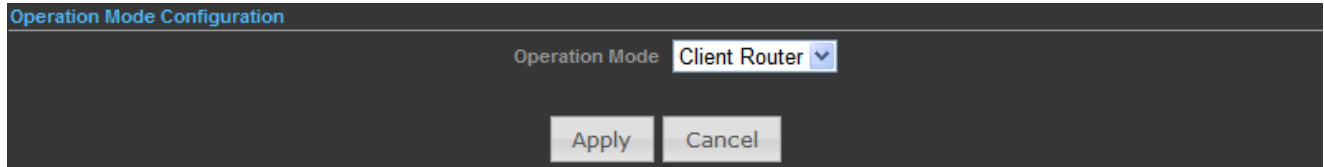

Figure 5-3-24

WISP Setup Procedure:

Step 1. Go to Advanced-> Wireless Settings-> Profile Settings.

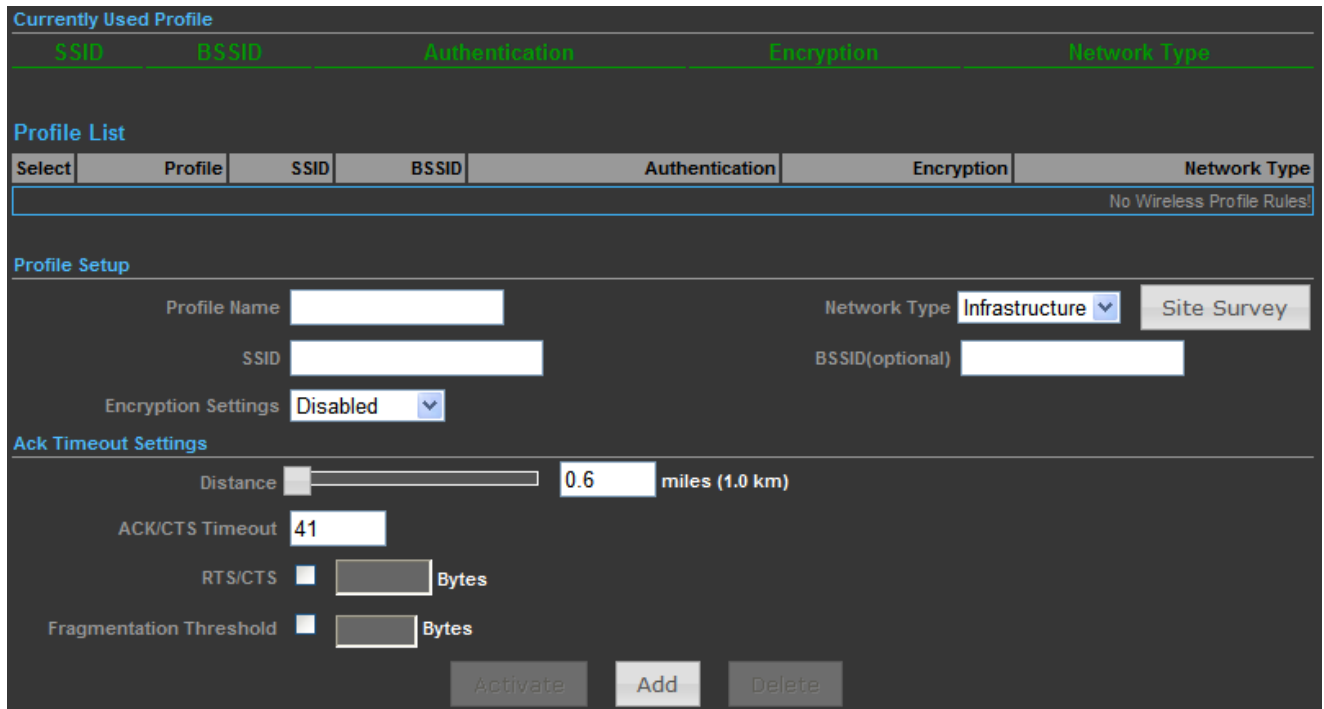
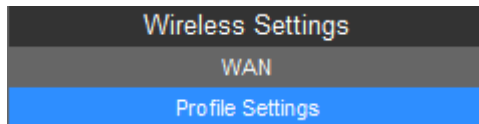

Figure 5-3-25

Step 2. Click “**Site Survey**” to discover the Wireless Internet Service Provider.

Step 3. Select the WISP’s AP, and the click “**Select**”.

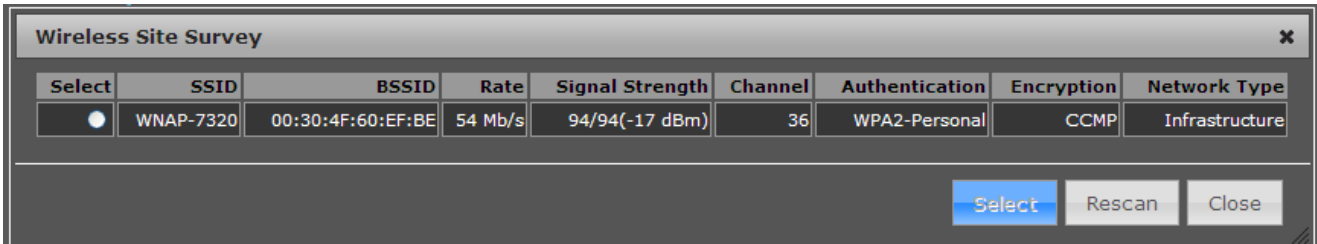

Figure 5-3-26

Step 4. Enter the Passphrase, and then click “Add” to add this setting to the profile.

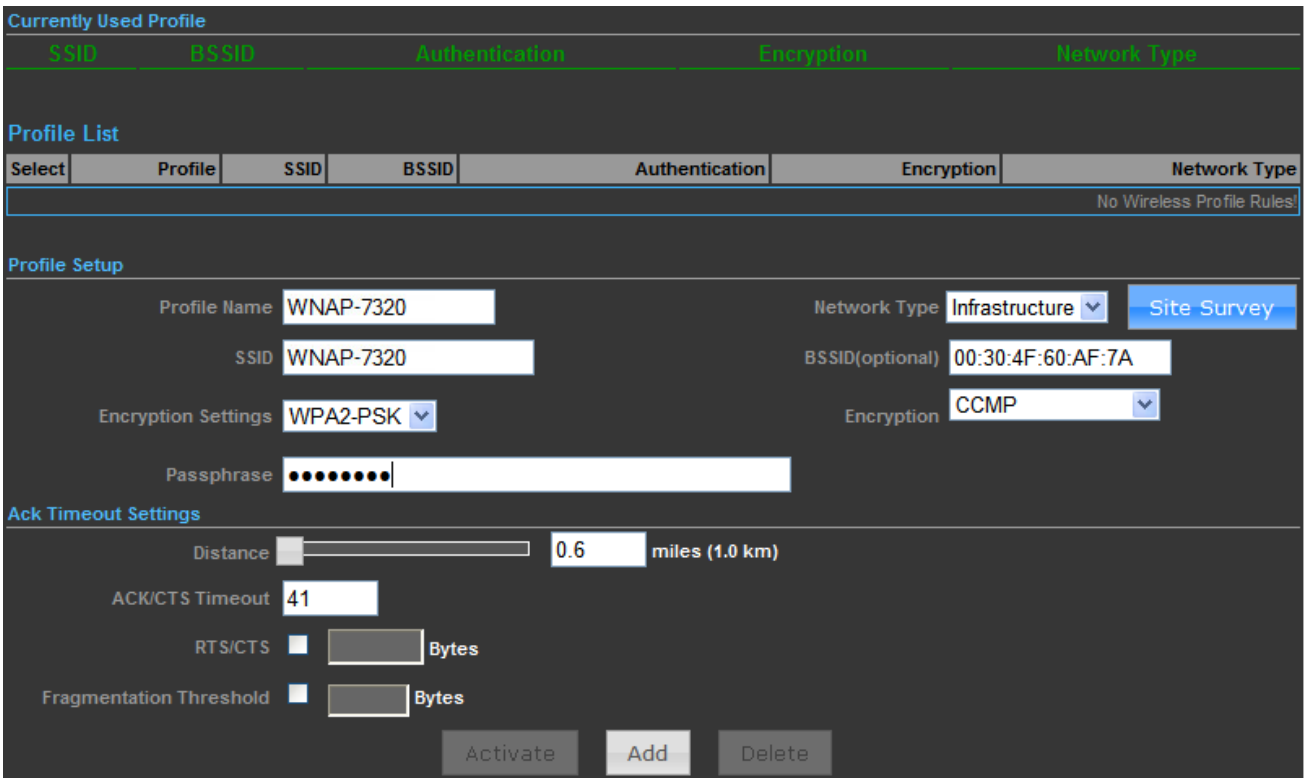

Figure 5-3-27

Step 5. The profile should be listed in the Profile List as the figure shown as below.

Currently Used Profile

SSID	BSSID	Authentication	Encryption	Network Type
WNAP-7320	00:30:4F:60:EF:BE	Disabled	Disabled	Infrastructure

Profile List

Select	Profile	SSID	BSSID	Authentication	Encryption	Network Type
<input type="radio"/>	WNAP-7320	WNAP-7320	00:30:4F:60:EF:BE	Disabled	Disabled	Infrastructure

Profile Setup

Profile Name: Network Type:

SSID: BSSID(optional):

Encryption Settings:

Ack Timeout Settings

Distance: miles (1.0 km)

ACK/CTS Timeout:

RTS/CTS: Bytes

Fragmentation Threshold: Bytes

WDS Client:

Figure 5-3-28

Step 6. Go to “Advanced-> Network Settings-> LAN” to enable DHCP Server.

LAN Setup

MAC Address: 00:30:4F:60:37:90

IP Address:

Subnet Mask:

DHCP Setup

DHCP Server:

Local Domain Name (Optional):

Start IP Address:

End IP Address:

Lease Time:

Figure 5-3-29

Step 7. Go to “Advanced-> Network Settings-> WAN” to configure the WAN Connection.

Wide Area Network (WAN) Settings

WAN Connections:

DHCP Mode

Hostname:

DNS Settings (Optional)

Primary DNS Server: Secondary DNS Server:

Figure 5-3-30

Step 8. Configure the wired client's TCP/IP setting to "Obtain an IP address automatically".



Figure 5-3-31

After got the IP assigned by the WNAP-7320, ping the DNS server to check whether internet connection is reachable.

5.3.3.4. Client Bridge (Slave AP Bridge)

In the Client Bridge Mode, the WNAP-7320 function likes a wireless adapter. Connected to an Access Point wirelessly and surf internet whenever you want. Using Site Survey to scan all the Access Point within the range and configure its SSID and Security Password to associate with it.



1. Connect the LAN port of WNAP-7320 to the POE port of the PoE Injector with an Ethernet cable.
2. Connect the PC to the LAN port of the PoE Injector with an Ethernet cable.
3. Plug one end of the power cord into the PoE Injector, and the other end in electrical socket.
4. Go to "Advanced-> Operation Mode" to configure it to **Client Bridge Mode**.

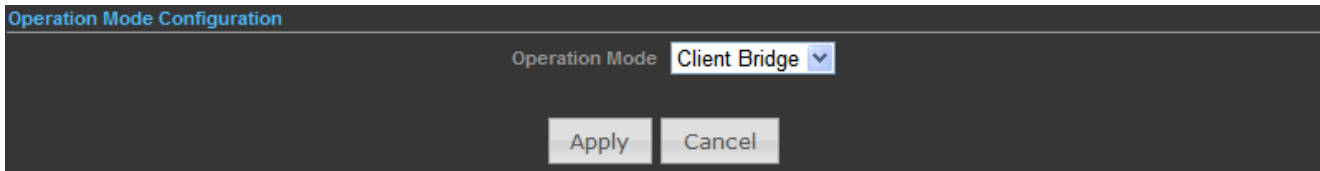
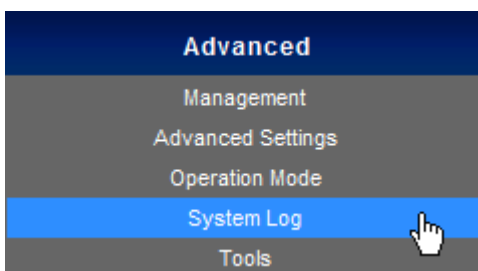

Figure 5-3-32

To configure the Wireless Settings of Client Bridge Mode, please refer to the section [5.6 Wireless Settings](#).

5.3.4 Advanced – System Log

Choose menu “**Advanced-> System Log**” to view the logs of the Wireless AP.



Click “**Refresh**” to update the system log.

Click “**Clear**” to erase the current system log.

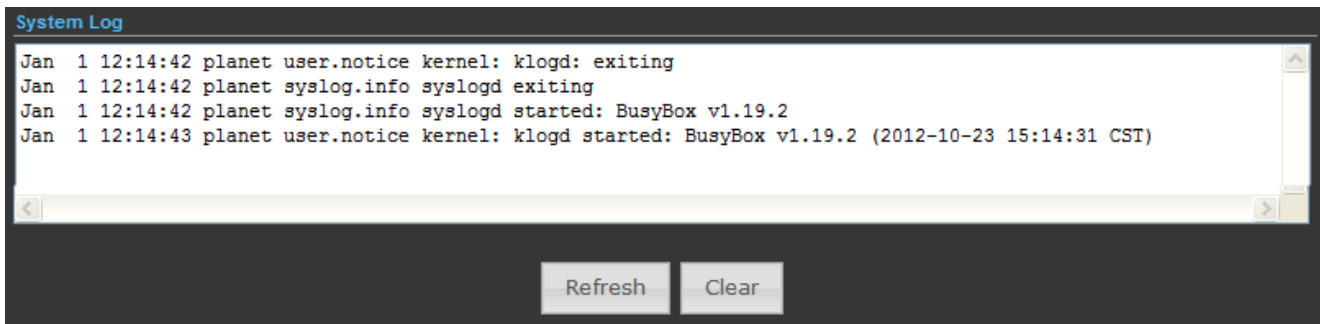
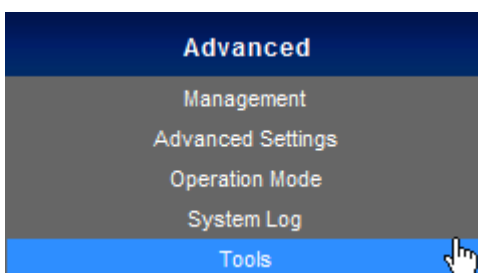

Figure 5-3-33

5.3.5 Advanced – Tools

The Tools included **Ping**, **Traceroute**, and **Throughput** can help user diagnostic the network connection.



5.3.5.1. Ping

Ping is a network tool used to test whether a particular host is reachable across an IP network.

Enter the IP, Ping Count, and click “**Start**” to diagnostic your internet connection.

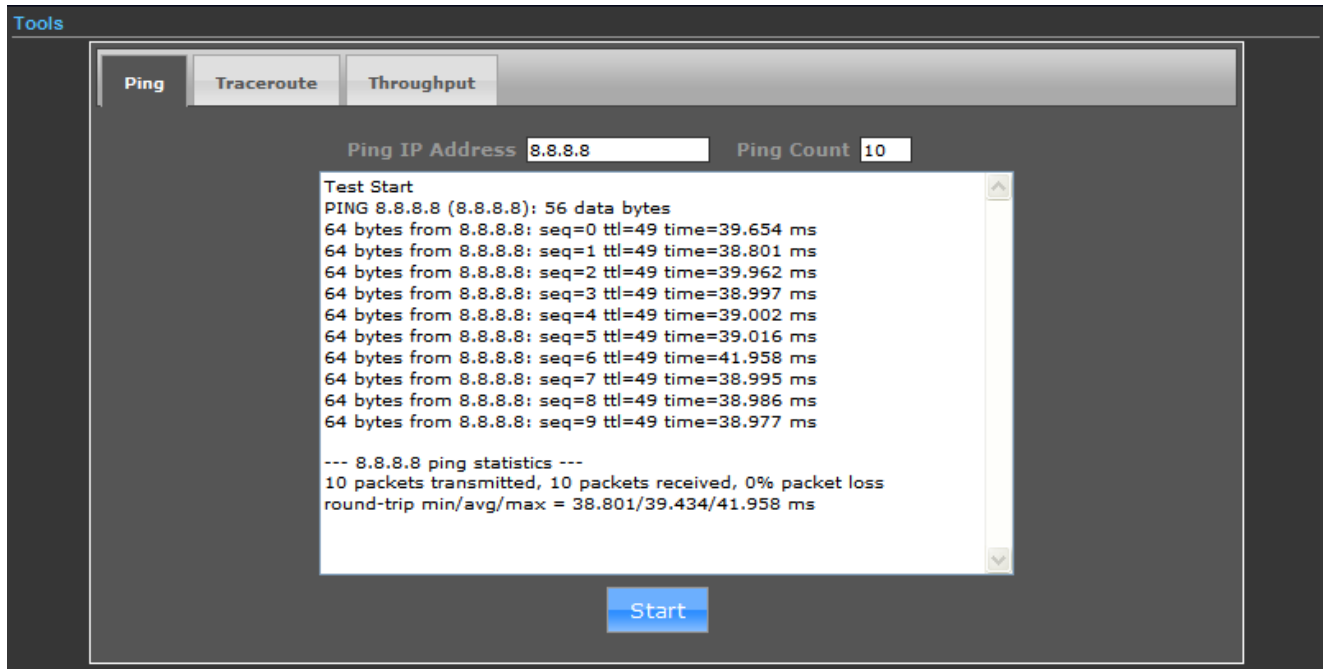

Figure 5-3-34

5.3.5.2. Traceroute

Traceroute is a computer network diagnostic tool for displaying the route (path) and measuring transit delays of packets across an Internet Protocol (IP) network. It can help identify connection problems.

Enter the IP or Hostname, and click “**Start**” to diagnostic your internet connection.

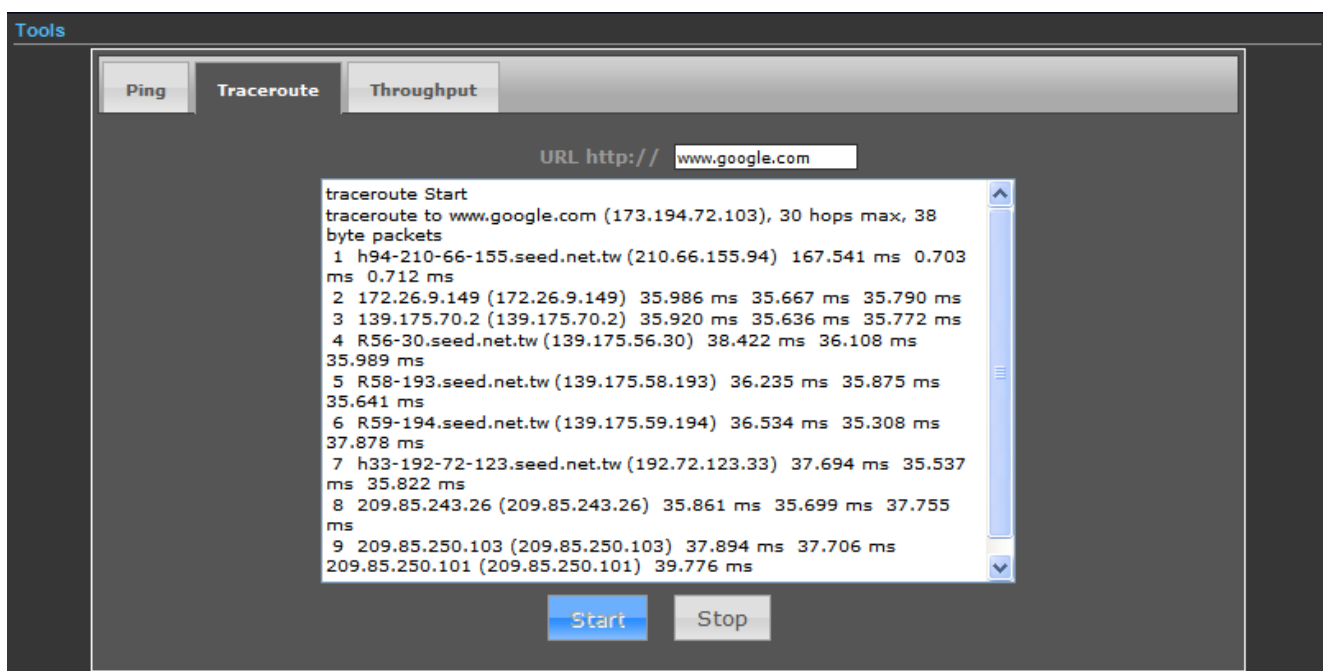

Figure 5-3-35

5.3.5.3. Throughput

Click “VISIT THE SITE TO TEST SPEED” button to go <http://www.speedtest.net/> to test the internet connection speed.

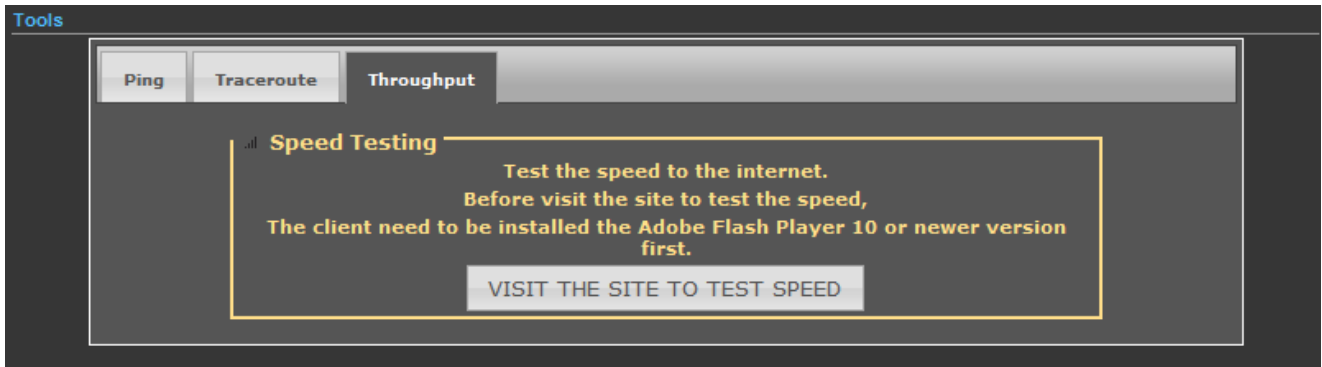
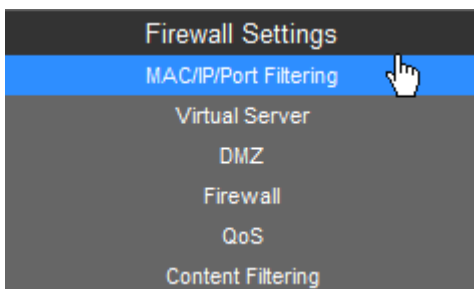

Figure 5-3-36

5.4 Firewall Settings

5.4.1 MAC/IP/Port Filtering



Basic Settings

MAC/IP/Port Filtering Default Policy: Describes how packets not matching any rules will be handled

MAC/IP/Port Filter Settings

MAC address

Destination IP address (DIP) Source IP address (SIP)

Protocol

Destination Port Range (DPR) - Source Port Range (SPR) -

Action

Comment

(The maximum rule count is 32.)

Current MAC/IP/Port filtering rules in system

No.	MAC address	DIP	SIP	Protocol	DPR	SPR	Action	Comment
Others would be accepted								

Figure 5-4-1

The page includes the following fields:

Object	Description
• MAC/IP/Port Filtering	Select Enable to enable the MAC/IP/Port Filtering function.
• Default Policy	Select a policy for filtering rule.
• MAC Address	Fill in the MAC address of source NIC, to restrict data transmission.
• Destination IP address (DIP)	Fill in the IP address of destination, to restrict data transmission.
• Source IP address (SIP)	Fill in the IP address of source, to restrict data transmission.
• Protocol	Select the protocol that you want to restrict. There are four options: None, TCP, UDP and ICMP.
• Destination Port Range	Fill in the start-port and end-port number of destination, to restrict data transmission.
• Source Port Range	Fill in the start-port and end-port number of source, to restrict data transmission.
• Action	Select Accept or Drop to specify the action of filtering policies.
• Comment	Make a comment for the filtering policy.

5.4.2 Virtual Server

The screenshot displays the configuration interface for the Virtual Server feature. It includes a navigation menu on the left, a main configuration area with a toggle and an 'Apply' button, a settings section with input fields for IP Address, Private Port, Public Port, Protocol (set to TCP&UDP), and Comment, and a table for existing virtual servers. The table has columns for No., IP Address, Port Mapping, Protocol, and Comment. Below the table are 'Delete Selected' and 'Reset' buttons. A note indicates that the maximum rule count is 32.

Figure 5-4-2

The page includes the following fields:

Object	Description
• Virtual Server	Select Enable to enable the Virtual Server function.
• IP address	To forward data packets coming from WAN to a specific IP address that hosted in local network behind the NAT firewall, fill in the IP address.
• Private Port	To forward data packets coming from WAN to a specific IP address that hosted in local network behind the NAT firewall, fill in the private port.
• Public Port	To forward data packets coming from WAN to a specific IP address that hosted in local network behind the NAT firewall, fill in the public port.

<ul style="list-style-type: none"> • Protocol 	The protocol used for this application, either of TCP, UDP, or TCP&UDP (all protocols are supported by the Device.).
<ul style="list-style-type: none"> • Comment 	Make a comment to help identify the setting.

5.4.3 DMZ

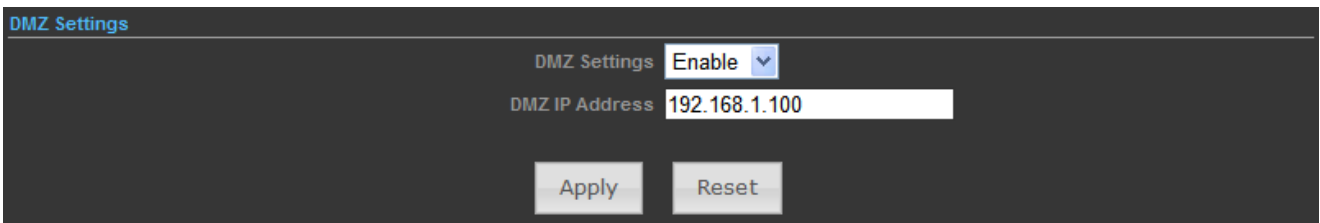
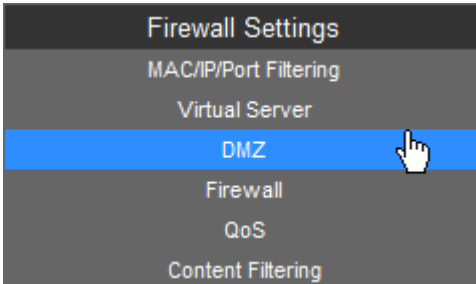

Figure 5-4-3

The page includes the following fields:

Object	Description
<ul style="list-style-type: none"> • DMZ Settings 	Select Enable to enable the DMZ function.
<ul style="list-style-type: none"> • DMZ IP Address 	To support DMZ in your firewall design, fill in the IP address of DMZ host that can be access from the WAN interface.

5.4.4 Firewall

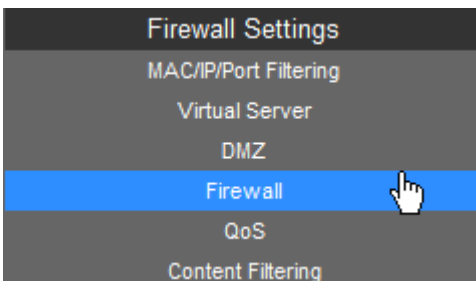

Figure 5-4-4

The page includes the following fields:

Object	Description
<ul style="list-style-type: none"> • Remote Management (via WAN) 	Select Deny or Allow for remote management function.
<ul style="list-style-type: none"> • Remote Management Port 	Configure the port for remote management.
<ul style="list-style-type: none"> • Ping from WAN Filter 	Select Deny or Allow for Ping permit from WAN.
<ul style="list-style-type: none"> • SPI Firewall 	Select Disable or Enable for SPI firewall function.
<ul style="list-style-type: none"> • Network Address Translation 	Enable it to let the LAN devices connect to the internet. All computers must be assigned with a public IP address to get connected to the Internet without NAT. However, Internet Service Providers only provide very few IP addresses to every user. Therefore it is necessary to use NAT to share a single public IP address to multiple computers on local network, so everyone can get connected to the Internet.
<ul style="list-style-type: none"> • PPPoE Passthrough 	Enable it to allow Multiple PPP connections on remote hosts.

5.4.5 QoS

Quality of Service provides an efficient way for clients on the network to share the bandwidth with a promised quality of Internet service. Without QoS, all computers and devices on the network will compete with each other to get the bandwidth, and some applications which require guaranteed bandwidth (like video streaming and network telephone) will be affected. With this function, you can limit the maximum bandwidth or give a guaranteed bandwidth for a specific computer, to avoid such displeasing result from happening.

The screenshot displays the configuration interface for Quality of Service (QoS) settings. It is divided into three main sections:

- Firewall Settings:** A vertical menu on the left with options: Firewall Settings, MAC/IP/Port Filtering, Virtual Server, DMZ, Firewall, **QoS** (highlighted in blue), and Content Filtering. A mouse cursor is pointing at the QoS option.
- Quality of Service Settings:**
 - QoS Setup:** A dropdown menu set to "Enable".
 - Upload Bandwidth:** A text input field containing "2048" kbps.
 - Download Bandwidth:** A text input field containing "10240" kbps.
 - Buttons: "Apply" and "Cancel".
- QoS Rules Setting:**
 - Target:** Radio buttons for Priority (selected), Express, Normal, and Low.
 - Source IP:** Two empty text input fields.
 - Destination IP:** Two empty text input fields.
 - Application:** A dropdown menu set to "all".
 - Protocol:** Radio buttons for all (selected), TCP, UDP, ICMP, and Custom.
 - Ports:** A text input field with a "?" icon.
 - Number of Bytes:** A text input field with a "?" icon.
 - Text: "(content filter message 8.)"
 - Buttons: "Add" and "Reset".
- Current QoS Rules in system:**

No	Target	Source	Destination	Application	Protocol	Ports	Num of Bytes
1	Express	all	all	all	all	22,53	
2	Low	all	all	all	tcp	20,21,25,80,110,443,993,995	
3	Normal	all	all	all	all	5190	

 - Buttons: "Delete Selected" and "Reset".

Figure 5-4-5

The page includes the following fields:

Object	Description
• QoS Setup	Select Enable to enable the QoS function.
• Upload Bandwidth	Set the limit of total upload bandwidth in kbits. To disable upload bandwidth limitation, input '0' here.
• Download Bandwidth	Set the limit of total download bandwidth in kbits. To disable download bandwidth limitation, input '0' here.
• Target	Set the target of QoS rule.
• Source IP	Specify the local (source) IP address that will be affected by this rule. Please input the starting IP address in the left field, and input the end IP address in the right field to define a range of IP addresses, or just input the IP address in the left field to define a single IP address.

<ul style="list-style-type: none"> • Destination IP 	Specify the remote (destination) IP address that will be affected by this rule. Please input the starting IP address in the left field, and input the end IP address in the right field to define a range of IP addresses, or just input the IP address in the left field to define a single IP address.
<ul style="list-style-type: none"> • Application 	Select the pre-defined application for this rule.
<ul style="list-style-type: none"> • Protocol 	Please select the protocol type of this rule. If you don't know what protocol your application uses, please try 'TCP' first, and switch to 'UDP' if this rule doesn't seem to work.
<ul style="list-style-type: none"> • Ports 	Fill out the ports for this rule.
<ul style="list-style-type: none"> • Number of Bytes 	Fill out the max. Number of bytes for this rule.

5.4.6 Content Filtering

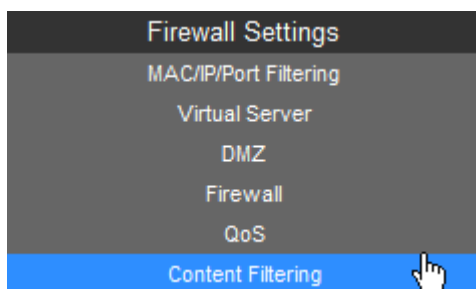

There are two types (Webs URL Filter Settings and Web Host Filter Settings) of content filtering.

5.4.6.1. Webs URL Filter Settings

The Webs URL Filter option allows you to set up a list of Web sites you would like to deny through your network. Please enter a URL for filtering.

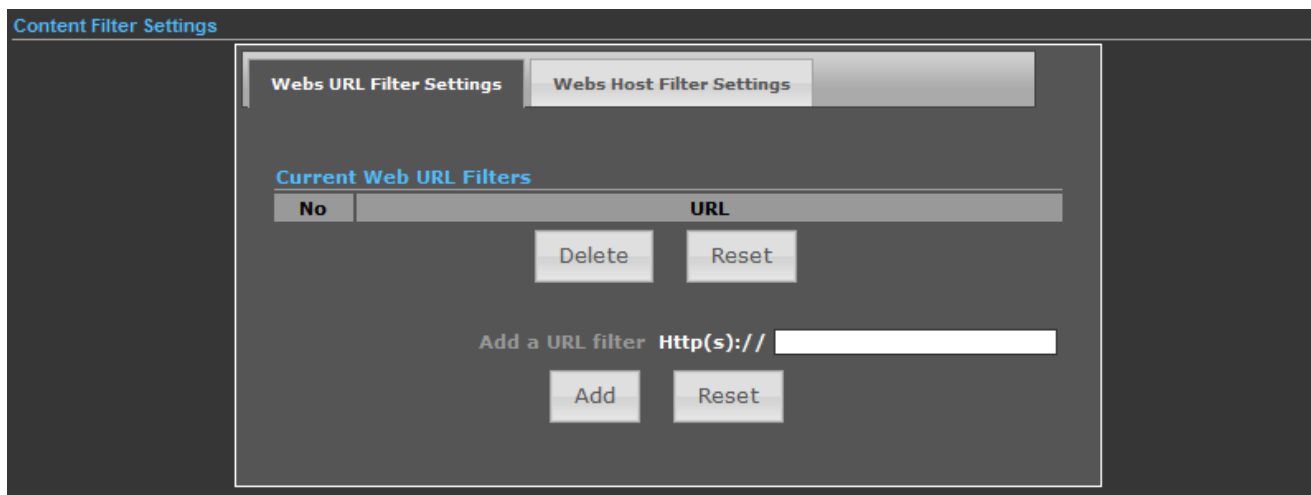

Figure 5-4-6

5.4.6.2. Web Host Filter Settings

The Webs Host Filter option allows you to set up a list of keyword you would like to deny through your network. Please enter a Host (keyword) for filtering.

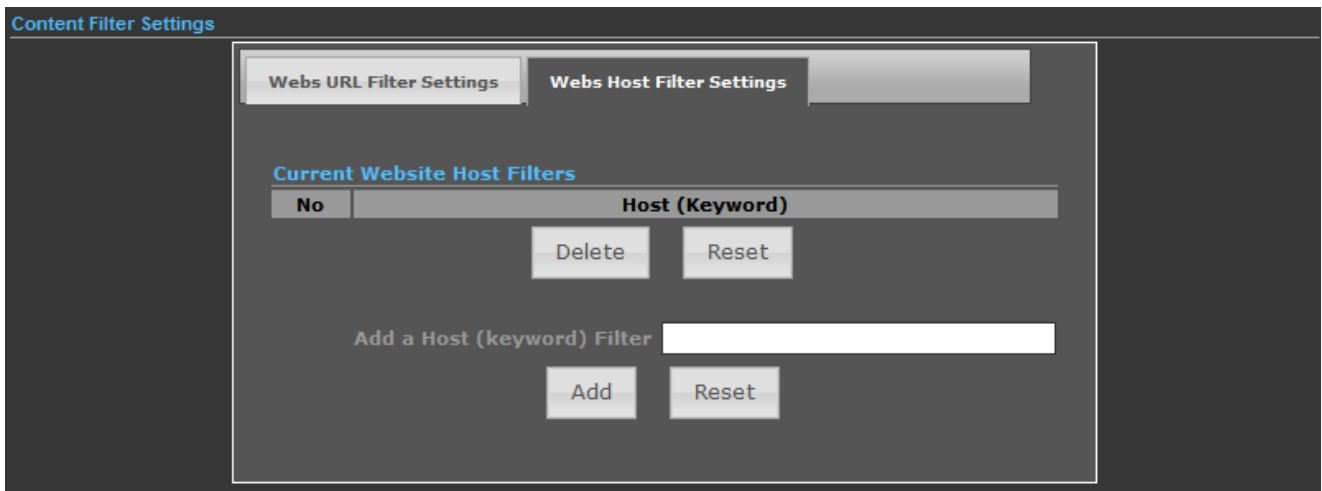
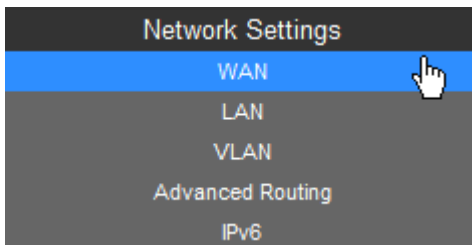

Figure 5-4-7

5.5 Network Settings

5.5.1 WAN

There are 5 submenus under the Network menu: **WAN**, **LAN**, **VLAN**, **Advanced Routing** and **IPv6**. Click any of them, and you will be able to configure the corresponding function.



WAN Connection Types:

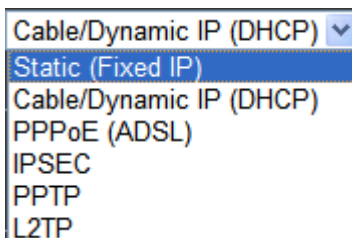

5.5.1.1. Static (Fixed IP)

If your ISP provides a static or fixed IP Address, Subnet Mask, Gateway and DNS setting, select **Static (Fixed IP)**. The Static IP settings page will appear as the figure shown as below.

Figure 5-5-1

The page includes the following fields:

Object	Description
• WAN Connections	Select Static (Fixed IP) from the list.
• IP Address	Enter the IP address in dotted-decimal notation provided by your ISP.
• Subnet Mask	Enter the subnet Mask in dotted-decimal notation provided by your ISP, usually is 255.255.255.0
• Default Gateway	(Optional) Enter the gateway IP address in dotted-decimal notation provided by your ISP.
• Primary DNS Server	(Optional) Enter the DNS IP address in dotted-decimal notation provided by your ISP.
• Secondary DNS Server	(Optional) Enter another DNS IP address in dotted-decimal notation provided by your ISP.

5.5.1.2. Cable/Dynamic IP (DHCP)

If your ISP provides the DHCP service, please choose **Cable/Dynamic IP (DHCP)** type, and the AP Router will automatically obtain IP parameters from your ISP. You can see the page shown as the below.

The screenshot displays the configuration interface for the WNAP-7320. The top section is titled "Wide Area Network (WAN) Settings". It includes a "WAN Connections" dropdown menu set to "Cable/Dynamic IP (DHCP)". Below this is the "DHCP Mode" section with a "Hostname" field containing "planet". The "DNS Settings (Optional)" section has "Primary DNS Server" set to "8.8.8.8" and "Secondary DNS Server" set to "168.95.1.1". "Apply" and "Cancel" buttons are visible at the bottom of this section. A large red arrow points downwards from the "Apply" button to the "Internet Configuration" section below. The "Internet Configuration" section shows "Connected Type" as "DHCP" and "Connected Status" as "Connected". It lists "WAN IP Address" as "192.168.2.150", "Subnet Mask" as "255.255.255.0", "Default Gateway" as "192.168.2.1", "Primary Domain Name Server" as "8.8.8.8", and "Secondary Domain Name Server" as "168.95.1.1". The "LAN Configuration" section shows "LAN IP Address" as "192.168.1.1" and "LAN Netmask" as "255.255.255.0". The "System Info" section shows "Firmware Version" as "V2.6 2012-10-23-15:12", "System Time" as "Sun, 01 Jan 2012 12:03:11", "Operation Mode" as "AP Router mode", and "Wireless MAC Address" as "00:30:4F:60:37:92".

Figure 5-5-2

The page includes the following fields:

Object	Description
• WAN Connections	Select Cable/Dynamic IP (DHCP) from the list.
• Host Name	This option specifies the Host Name of the AP Router.
• Primary DNS Server	(Optional) Enter the DNS IP address in dotted-decimal notation provided by your ISP.
• Secondary DNS Server	(Optional) Enter another DNS IP address in dotted-decimal notation provided by your ISP.

5.5.1.3. PPPoE (ADSL)

If local ISP provides a PPPoE connection, choose **PPPoE (ADSL)** and fill the necessary parameters below.

The screenshot displays the 'Wide Area Network (WAN) Settings' interface. At the top, 'WAN Connections' is set to 'PPPoE (ADSL)'. Below this, the 'PPPoE Mode' section includes:

- User Name: pppoe_user
- Password: [masked]
- Verify Password: [masked]
- Operation Mode: Keep Alive
- Keep Alive Mode: Redial Period: 60 Seconds
- MTU: 1492 bytes (Default=1492)

 The 'DNS Settings (Optional)' section includes:

- Primary DNS Server: 8.8.8.8
- Secondary DNS Server: 168.95.1.1

 At the bottom, there are 'Apply' and 'Cancel' buttons.

Figure 5-5-3

The page includes the following fields:

Object	Description
• WAN Connections	Select PPPoE (ADSL) from the list.
• Host Name	This option specifies the Host Name of the AP Router.
• User Name / Password	Enter the User Name and Password provided by your ISP. These fields are case-sensitive.
• Verify Password	Enter the same password entered above for the confirmation.
• Operation Mode	Keep Alive: Being constantly connected.
• Keep Alive Mode	Set up the redial period after the disconnection. The default setting is " 60 seconds ".
• MTU	Please input the MTU value of your network connection here. If you don't know, please keep the default value.
• Primary DNS Server	(Optional) Enter the DNS IP address in dotted-decimal notation provided by your ISP.
• Secondary DNS Server	(Optional) Enter another DNS IP address in dotted-decimal notation provided by your ISP.

5.5.1.4. IPSEC

If your ISP provides IPSEC connection, please select **IPSEC**. And enter the following parameters.

Figure 5-5-4

Figure 5-5-5

The page includes the following fields:

Object	Description
<ul style="list-style-type: none"> • WAN Connections 	Select IPSEC from the list.
<ul style="list-style-type: none"> • Primary DNS Server 	(Optional) Enter the DNS IP address in dotted-decimal notation provided by your ISP.
<ul style="list-style-type: none"> • Secondary DNS Server 	(Optional) Enter another DNS IP address in dotted-decimal notation provided by your ISP.

<ul style="list-style-type: none"> • Connection address family 	<p>For an IPsec connection, all host addresses must be of the same Address Family (IPv4 and IPv6 use different Address Families).</p>						
<ul style="list-style-type: none"> • IPsec Operation Mode 	<p>Select the IPsec Operation Mode from the drop-down list.</p>						
<ul style="list-style-type: none"> • IPsec Connection Type 	<p>This field allows you to set the connection type to any of the following:</p> <p>Select Tunnel to specify a Host to Host, Host to Subnet (Road Warrior), or Subnet to Subnet Tunnel. This is by far the most common connection type.</p> <p>Select Transport to specify a Host to Host Transport mode tunnel. This connection type is much less common, and would generally only be used if you are attempting to establish an IPsec connection to another host which specifically requires this mode.</p> <p>Select Passthrough to disable IPsec processing on packets associated with the tunnel. We can't imagine a scenario where you would use this connection type. I mean seriously, if you don't allow IPsec to process the packets then you don't really have a tunnel, right? Still, the underlying protocol supports this mode, and so here we are.</p> <p>Select Drop to cause the kernel to drop IPsec packets associated with the tunnel.</p> <p>Select Reject to cause the kernel to reject IPsec packets associated with the tunnel.</p>						
<ul style="list-style-type: none"> • PFS DH Group 	<p>Perfect Forward Secrecy (PFS)—PFS ensures that a given IPsec SA key was not derived from any other secret, like some other keys. In other words, if someone breaks a key, PFS ensures that the attacker is not able to derive any other key. If PFS is not enabled, someone can potentially break the IKE SA secret key, copy all the IPsec protected data, and then use knowledge of the IKE SA secret in order to compromise the IPsec SAs setup by this IKE SA. With PFS, breaking IKE does not give an attacker immediate access to IPsec. The attacker needs to break each IPsec SA individually.</p> <p>Diffie-Hellman (DH) key exchange protocol allows two parties without any initial shared secret to create one securely. The following Modular Exponential (MODP) and Elliptic Curve (EC2N) Diffie-Hellman (also known as "Oakley") Groups are supported:</p> <table border="1" data-bbox="539 2000 1396 2098"> <thead> <tr> <th>Diffie-Hellman Group</th> <th>Name</th> <th>Reference</th> </tr> </thead> <tbody> <tr> <td>Group 1</td> <td>768 bit MODP group</td> <td>RFC 2409</td> </tr> </tbody> </table>	Diffie-Hellman Group	Name	Reference	Group 1	768 bit MODP group	RFC 2409
Diffie-Hellman Group	Name	Reference					
Group 1	768 bit MODP group	RFC 2409					

	<table border="1"> <tbody> <tr> <td>Group 2</td> <td>1024 bits MODP group</td> <td>RFC 2409</td> </tr> <tr> <td>Group 3</td> <td>EC2N group on GP(2¹⁵⁵)</td> <td>RFC 2409</td> </tr> <tr> <td>Group 4</td> <td>EC2N group on GP(2¹⁸⁵)</td> <td>RFC 2409</td> </tr> <tr> <td>Group 5</td> <td>1536 bits MODP group</td> <td>RFC 3526</td> </tr> </tbody> </table>	Group 2	1024 bits MODP group	RFC 2409	Group 3	EC2N group on GP(2 ¹⁵⁵)	RFC 2409	Group 4	EC2N group on GP(2 ¹⁸⁵)	RFC 2409	Group 5	1536 bits MODP group	RFC 3526
Group 2	1024 bits MODP group	RFC 2409											
Group 3	EC2N group on GP(2 ¹⁵⁵)	RFC 2409											
Group 4	EC2N group on GP(2 ¹⁸⁵)	RFC 2409											
Group 5	1536 bits MODP group	RFC 3526											
• IPSec Authentication	The AP supports SHA1 & MD5 authentication algorithms.												
• IPSec Encryption	<p>The AP supports DES, 3DES, AES, Blowfish, Twofish, Camellia Encryption methods.</p> <p>DES - 56-bit DES-CBC encryption algorithm</p> <p>3DES - 168-bit DES encryption algorithm</p> <p>AES - 128, 192 and 256-bit key AES-CBC encryption algorithm</p> <p>Blowfish - a symmetric block cipher that can be used as a drop-in replacement for DES or IDEA. It takes a variable-length key, from 32 bits to 448 bits.</p> <p>Twofish - Twofish has a 128-bit block size, a key size ranging from 128 to 256 bits, and is optimized for 32-bit CPUs.</p> <p>Camellia - 128, 192 and 256-bit key Camellia encryption algorithm</p>												
• SA connection Life Time	This value describes the timeframe in hours for which the IKE SA is valid and when the next rekeying should take place.												
• IKE Key Tries	The field is used to specify the retry times of IKE Key.												
• Local IP Address	This field is used to configure the IP address of the Untangle server on the network configured in the Local Network field.												
• Peer IP Address	This field should contain the public IP address of the host to which the IPSec VPN will be connected.												
• Local Subnet	This field is used to configure the local network that will be reachable from hosts on the other side of the IPSec VPN.												
• Peer Subnet	This field is used to configure the remote network that will be reachable from hosts on the local side of the IPSec VPN.												
• Local Gateway	This field is used to configure the Gateway of the Untangle server on the network configured in the Local Network field.												
• Peer Gateway	This field should contain the public Gateway of the host to which the IPSec VPN will be connected.												
• IPSec Tunnel Name	This field should contain a short name or description.												
• IPSec Secret Key	This field should contain the shared secret or PSK (pre-shared key) that is used to authenticate the connection, and must be the same on both sides of the tunnel for the connection to be successful. Because the PSK is actually used as the encryption key for the session, using long strings of a random nature will provide the highest level of security.												

<ul style="list-style-type: none"> • IPSec Key Life time 	<p>Lifetime settings determine when a new key is generated. Any time a key lifetime is reached, the associated SA is also renegotiated. The process of generating new keys at intervals is called dynamic rekeying or key regeneration. Lifetimes allow you to force the generation of a new key after a specific interval. For example, if the communication takes 12 hours and you specify the key lifetime as 1 hour, 12 keys will be generated (one every 1 hour) during the exchange.</p>
<ul style="list-style-type: none"> • NAT Traversal 	<p>NAT Traversal also known as UDP encapsulation allows traffic to get to the specified destination when a device does not have a public address. This is usually the case if your ISP is doing NAT, or the external interface of your firewall is connected to a device that has NAT enabled.</p>
<ul style="list-style-type: none"> • Perfect Forward Secrets 	<p>Select the checkbox to enable PFS (Perfect Forward Secrets).</p>
<ul style="list-style-type: none"> • IPSec Compression 	<p>Select the checkbox to enable compression of content on the connection.</p>
<ul style="list-style-type: none"> • IPSec Conn. Keep Alive 	<p>When the firewall is located behind a NAT device, it sends keep alive packets to maintain the connection. You can also force it to send keep alive packets for all NAT-T connections.</p>
<ul style="list-style-type: none"> • IPSec Tunnel UP 	<p>This field indicates the IPSec Tunnel is UP and running.</p>

5.5.1.5. PPTP

If your ISP provides PPTP connection, please select **PPTP**. And enter the following parameters.

The screenshot shows the 'Wide Area Network (WAN) Settings' interface. At the top, 'WAN Connections' is set to 'PPTP'. Under 'PPTP Mode', the following fields are visible: 'Server IP' with the value 'pptp_server', 'User Name' with 'pptp_user', 'Password' (masked with dots), 'Address Mode' set to 'Static IP', 'IP Address' and 'Subnet Mask' (empty), 'Operation Mode' set to 'Keep Alive', and 'Keep Alive Mode: Redial Period' set to '60'. Below this, 'DNS Settings (Optional)' shows 'Primary DNS Server' as '8.8.8.8' and 'Secondary DNS Server' as '168.95.1.1'. At the bottom, there are 'Apply' and 'Cancel' buttons.

Figure 5-5-6

The page includes the following fields:

Object	Description
<ul style="list-style-type: none"> • WAN Connections 	Select PPTP from the list.

• Server IP	Enter the IP address of the PPTP server.
• User Name / Password	Enter the User Name and Password provided by your ISP. These fields are case-sensitive.
• Address Mode	Static IP/ Dynamic IP: Choose either as you are given by your ISP and If you choose static IP and enter the domain name, you should also enter the DNS assigned by your ISP. And click the Save button.
• IP Address	Enter the User Name and Password provided by your ISP. These fields are case-sensitive.
• Subnet Mask	Enter the subnet Mask in dotted-decimal notation provided by your ISP, usually is 255.255.255.0
• Operation Mode	Keep Alive: Being constantly connected.
• Keep Alive Mode	Set up the redial period after the disconnection. The default setting is " 60 seconds ".
• Primary DNS Server	(Optional) Enter the DNS IP address in dotted-decimal notation provided by your ISP.
• Secondary DNS Server	(Optional) Enter another DNS IP address in dotted-decimal notation provided by your ISP.

5.5.1.6. L2TP

If your ISP provides L2TP connection, please select **L2TP**. And enter the following parameters.

The screenshot shows the 'Wide Area Network (WAN) Settings' interface. At the top, 'WAN Connections' is set to 'L2TP'. Below this, the 'L2TP Mode' section contains several input fields: 'Server IP' with the value 'l2tp_server', 'User Name' with 'l2tp_user', 'Password' which is masked with dots, 'Address Mode' set to 'Static IP', 'IP Address' and 'Subnet Mask' which are empty, 'Operation Mode' set to 'Keep Alive', and 'Keep Alive Mode: Redial Period' set to '60'. The 'DNS Settings (Optional)' section at the bottom shows 'Primary DNS Server' as '8.8.8.8' and 'Secondary DNS Server' as '168.95.1.1'. 'Apply' and 'Cancel' buttons are located at the bottom center of the form.

Figure 5-5-7

The page includes the following fields:

Object	Description
• WAN Connections	Select L2TP from the list.
• Server IP	Enter the IP address of the L2TP server.

• User Name / Password	Enter the User Name and Password provided by your ISP. These fields are case-sensitive.
• Address Mode	Static IP/ Dynamic IP: Choose either as you are given by your ISP and If you choose static IP and enter the domain name, you should also enter the DNS assigned by your ISP. And click the Save button.
• IP Address	Enter the User Name and Password provided by your ISP. These fields are case-sensitive.
• Subnet Mask	Enter the subnet Mask in dotted-decimal notation provided by your ISP, usually is 255.255.255.0
• Operation Mode	Keep Alive: Being constantly connected.
• Keep Alive Mode	Set up the redial period after the disconnection. The default setting is " 60 seconds ".
• Primary DNS Server	(Optional) Enter the DNS IP address in dotted-decimal notation provided by your ISP.
• Secondary DNS Server	(Optional) Enter another DNS IP address in dotted-decimal notation provided by your ISP.

5.5.2 LAN

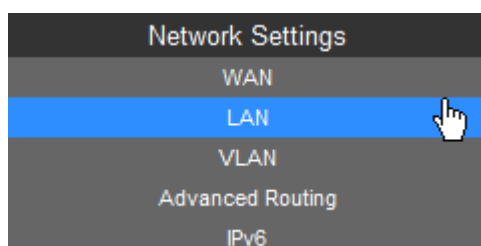

LAN Setup

MAC Address 00:30:4F:60:37:90

IP Address

Subnet Mask

Figure 5-5-8

The page includes the following fields:

Object	Description
• MAC Address	Display the LAN port MAC address of the Wireless AP.
• IP Address	The Wireless AP's LAN IP. The default is 192.168.1.1 . You can change it according to your need.
• Subnet Mask	Enter the subnet mask of the LAN IP.

5.5.2.1. DHCP Server

The screenshot shows the DHCP Setup configuration interface. The 'DHCP Server' dropdown menu is set to 'DHCP Server'. The 'Local Domain Name (Optional)' field is empty. The 'Start IP Address' is set to 192.168.1.100 and the 'End IP Address' is set to 192.168.1.199. The 'Lease Time' dropdown menu is set to 'One day'. There are 'Apply' and 'Cancel' buttons at the bottom of the form.

Figure 5-5-9

The page includes the following fields:

Object	Description
• DHCP Server	Select DHCP Server to enable DHCP server feature.
• Local Domain Name (Optional)	(Optional) Input the domain name of your network.
• Start IP Address	Enter the starting IP address for the DHCP server's IP assignment.
• End IP Address	Enter the ending IP address for the DHCP server's IP assignment.
• Lease Time	The length of time for the IP address lease. Configuring a proper lease time improves the efficiency for the DHCP server to reclaim disused IP addresses.

To benefit from the DHCP server feature, you must set all LAN PCs to DHCP clients by selecting the “Obtain an IP Address Automatically” radio buttons thereon.

5.5.2.2. DHCP Relay

The screenshot shows the DHCP Setup configuration interface. The 'DHCP Server' dropdown menu is set to 'DHCP Relay'. The 'DHCP Relay' field contains the IP address 192.168.23.168. There are 'Apply' and 'Cancel' buttons at the bottom of the form.

Figure 5-5-10

The page includes the following fields:

Object	Description
• DHCP Server	Select DHCP Relay to enable DHCP relay feature.
• DHCP Relay	A DHCP relay agent is any host that forwards DHCP packets between clients and servers. Configure the IP address of DHCP Relay host.

5.5.3 VLAN

VLAN Settings

VLAN Setup ▾

Management VLAN ID Enable Management VLAN

VLAN Group

VLAN ID eth0 eth1 SSID 1 SSID 2 Allow Untag

(The maximum VLAN group count is 8.)

Current VLAN Groups in system

No	VID	Members				UnTag
		eth0	eth1	SSID 1	SSID 2	
1 <input type="checkbox"/>	1			Yes		Deny
2 <input type="checkbox"/>	2				Yes	Deny

Figure 5-5-11

The page includes the following fields:

Object	Description
• VLAN Setup	Check this box to enable the VLAN function.
• Management VLAN ID	Configure a specified VLAN to be the management VLAN.
• Enable Management VLAN ID	Check this box to enable the Management VLAN function.
• VLAN ID	The ID of a VLAN. Only in the same VLAN can a wireless PC and a wired PC communicate with each other. The value can be between 1 and 4095. If the VLAN function is enabled, when AP forwards packets, the packets out from the LAN port will be added with an IEEE 802.1Q VLAN Tag, whose VLAN ID is just the ID of the VLAN where the sender belongs.

5.5.4 Advanced Routing

Network Settings

- WAN
- LAN
- VLAN
- Advanced Routing**
- IPv6

Advanced Routing Settings

Add a routing rule

Destination:

Type:

Gateway:

Interface:

Comment:

Current Routing table in the system

No.	Destination	Netmask	Gateway	Flags	Metric	Ref	Use	Interface	Comment
1	255.255.255.255	255.255.255.255	0.0.0.0	5	0	0	0	LAN(br0)	
2	210.66.155.0	255.255.255.0	0.0.0.0	1	0	0	0	eth0(eth0)	
3	192.168.1.0	255.255.255.0	0.0.0.0	1	0	0	0	LAN(br0)	
4	0.0.0.0	0.0.0.0	210.66.155.94	3	0	0	0	eth0(eth0)	

Dynamic Routing Protocol

RIP:

Figure 5-5-12

The page includes the following fields:

Object	Description
• Destination	The IP address of packets that can be routed.
• Type	Defines the type of destination. (Host: Signal IP address / Net: Portion of Network)
• Gateway	Defines the packets destination next hop
• Interface	Select interface to which a static routing subnet is to be applied
• Comment	Help identify the routing
• Dynamic Routing Protocol	Enable or disable the RIP (Routing Information Protocol) for the WAN or LAN interface. It supports RIP v1 and v2.

5.5.5 IPv6

Use this section to configure your IPv6 Connection type. If you are unsure of your connection method, please contact your Internet Service Provider.

The screenshot displays the IPv6 configuration page. At the top, a 'Network Settings' menu is visible with 'IPv6' selected. The main configuration area is divided into several sections:

- IPv6 Connection Mode:** A dropdown menu is set to 'DHCPv6'.
- DNS Address Server Setting:** Two input fields for 'IPv6 Primary DNS' and 'IPv6 Secondary DNS'.
- Prefix Delegation Setting:** Includes a checkbox for 'Enable DHCP-PD', an input field for 'SLD ID' (value: 0), and an input field for 'SLA Length' (value: 16).
- Lan IPv6 Address Setting:** Includes an input field for 'Lan IPv6 Address' (value: 2001:db8:1:2::1) and a dropdown for the prefix length (value: /64), and an input field for 'Lan IPv6 Link-Local Address' (value: /64).
- Lan Address Autoconfiguration:** Includes a dropdown for 'IPv6 Autoconfiguration' (value: Stateless(RADVD)) and an input field for 'IPv6 Address Lifetime' (value: 1800).

 At the bottom of the configuration area are 'Apply' and 'Cancel' buttons.

Figure 5-5-13

The page includes the following fields:

Object	Description
<ul style="list-style-type: none"> • IPv6 Connection Mode 	Choose the mode to be used by the AP/Router to the IPv6 Internet. There are 7 connection modes available: Static, SLAAC, DHCPv6, 6to4 Tunnel, 6in4 Tunnel, PPPoE, and Pass Through.
<ul style="list-style-type: none"> • DNS Address Server Setting 	Enter the IPv6 Primary DNS & IPv6 Secondary DNS to this section.
<ul style="list-style-type: none"> • Prefix Delegation Setting 	Enter the IPv6 Prefix Delegation information provided by your Internet Service Provider (ISP).
<ul style="list-style-type: none"> • LAN IPv6 Address Setting 	Use this section to configure the internal network settings of your AP/Router. If you change the LAN IPv6 Address here, you may need to adjust your PC network settings to access the network again.
<ul style="list-style-type: none"> • LAN Address Auto 	IPv6 offers two types of autoconfiguration: Stateful (DHCPv6) &

configuration	<p>Stateless (RADVD).</p> <p>Stateful (DHCPv6): This type of configuration is suitable for small organizations and individuals. It allows each host to determine its address from the contents of received user advertisements. It makes use of the IEEE EUI-64 standard to define the network ID portion of the address.</p> <p>Stateless(RADVD): With Stateless Autoconfiguration, a host gains an address via an interface automatically "leasing" an address and does not require the establishment of a server to delve out address space.</p>
----------------------	--

5.6 Wireless Settings

You could configure the minimum number of Wireless settings for communication, such as Network Name (SSID) and Channel. The Access Point can be set simply with only the minimum setting items.

5.6.1 Basic

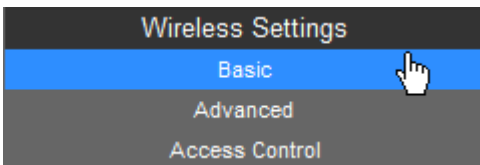

5.6.1.1. Wireless Mode – Access Point

Figure 5-6-1

The page includes the following fields:

Object	Description
<ul style="list-style-type: none"> • Wireless Mode 	<p>Click to select Wireless Mode from pull down menu.</p> <p>There are 4 options available:</p> <ul style="list-style-type: none"> ■ Access Point: This mode allows wireless clients or Stations(STA) to access ■ WDS Access Point: This mode enables the wireless interconnection of Access Point in an IEEE802.11 network .and accept wireless clients at the same time. ■ WDS Repeater: Set to this mode to enable the wireless access point repeat the signal of root access point using WDS. ■ WDS Client: Set to this mode to enable wireless client using WDS to connect to the WDS Access Point.
<ul style="list-style-type: none"> • Multiple SSID 	<p>There is one more SSID available. Select the checkbox to enable it, enter the descriptive names that you want to use.</p>
<ul style="list-style-type: none"> • Country Code 	<p>Set your country code by clicking the “Set Country Code”.</p>
<ul style="list-style-type: none"> • Frequency (Channel) 	<p>Set the channel you would like to use. The channel range will be changed by selecting different domain.</p>
<ul style="list-style-type: none"> • Site Survey 	<p>Click “Site Survey” button to observe the signal of remote sites.</p>
<ul style="list-style-type: none"> • Network Mode 	<p>Select the operating channel width to WiFi 11na (mixed), HT20 or HT40MHz.</p>
<ul style="list-style-type: none"> • Extension Channel 	<p>An extension channel is a secondary channel used to bond with the primary channel to increase this range to 40MHz. Bonded channels allow for greater bandwidth on the local network.</p>
<ul style="list-style-type: none"> • Distance 	<p>To decrease the chances of data retransmission at long distance, the IEEE 802.11a/n Wireless Outdoor CPE can automatically adjust proper ACK timeout value by specifying distance of the two nodes.</p>
<ul style="list-style-type: none"> • ACK/CTS Timeout 	<p>ACK/CTS Timeout settings are for long distance links. It is important to tweak settings to achieve the optimal result based on requirement.</p> <p>The device’s default settings should be sufficient for most applications.</p> <p>The value is auto determined by distance between the radios, data rate of average environment.</p>
<ul style="list-style-type: none"> • Network Name (SSID) 	<p>It is the wireless network name. The SSID can be 32 bytes long.</p> <p>User can use the default SSID or change it.</p> <p>The default SSID is WNAP-7320.</p>
<ul style="list-style-type: none"> • WPS Choice 	<p>Enable it to use WPS associating with AP or Client device.</p>

• Encryption Settings	Select the encryption type that you would like to use.
• WPA Algorithms	Select the WPA Algorithms that you would like to use.
• Key Renewal Interval (Seconds)	The key renewal time is the period of time that the AP uses the same key before a new one is generated.
• Pre-Shared Key	Data encryption and key are required for wireless authentication.

5.6.1.2. Wireless Mode – WDS Access Point

The screenshot shows the configuration interface for the WNAP-7320. It is divided into two main sections: 'Basic Wireless Settings' and 'SSID Security Settings'.

Basic Wireless Settings:

- Wireless Mode: WDS Access Point (dropdown menu)
- Country Code: United States (with a 'Set Country Code' button)
- Frequency (Channel): 5180 MHz (Channel 36) (dropdown menu)
- Site Survey: Site Survey (button)
- Network Mode: WiFi 11na HT20 (dropdown menu)
- Extension Channel: None (dropdown menu)
- Distance: 0.6 miles (1.0 km) (slider)
- ACK/CTS Timeout: 41 (input field)

SSID Security Settings:

- Network Name (SSID): WNAP-7320 (input field) with a 'Hide' checkbox.
- Encryption Settings: WPA2-PSK (dropdown menu)
- WPA Algorithms: TKIP (radio button), CCMP(AES) (radio button, selected), Auto (radio button)
- Key Renewal Interval(Seconds): 60 (input field)
- Pre-Shared Key: 12345678 (input field) with a 'Generator' button.

At the bottom of the SSID Security Settings section, there are 'Apply' and 'Cancel' buttons.

Figure 5-6-2

The page includes the following fields:

Object	Description
• Wireless Mode	<p>Click to select Wireless Mode from pull down menu.</p> <p>There are 4 options available:</p> <p>Access Point: This mode allows wireless clients or Stations(STA) to access</p> <p>WDS Access Point: This mode enables the wireless interconnection of Access Point in an IEEE802.11 network .and accept wireless clients at the same time.</p> <p>WDS Repeater: Set to this mode to enable the wireless access point repeat the signal of root access point using WDS.</p>

	<p>WDS Client:</p> <p>Set to this mode to enable wireless client using WDS to connect to the WDS Access Point.</p>
• Country Code	Set your country code by clicking the “ Set Country Code ”.
• Frequency (Channel)	Set the channel you would like to use. The channel range will be changed by selecting different domain.
• Site Survey	Click “ Site Survey ” button to observe the signal of remote sites.
• Network Mode	Select the operating channel width to WiFi 11na (mixed), HT20 or HT40MHz.
• Extension Channel	An extension channel is a secondary channel used to bond with the primary channel to increase this range to 40MHz. Bonded channels allow for greater bandwidth on the local network.
• Distance	To decrease the chances of data retransmission at long distance, the IEEE 802.11a/n Wireless Outdoor CPE can automatically adjust proper ACK timeout value by specifying distance of the two nodes.
• ACK/CTS Timeout	<p>ACK/CTS Timeout settings are for long distance links. It is important to tweak settings to achieve the optimal result based on requirement.</p> <p>The device’s default settings should be sufficient for most applications.</p> <p>The value is auto determined by distance between the radios, data rate of average environment.</p>
• Network Name (SSID)	<p>It is the wireless network name. The SSID can be 32 bytes long.</p> <p>User can use the default SSID or change it.</p> <p>The default SSID is WNAP-7320.</p>
• Encryption Settings	Select the encryption type that you would like to use.
• WPA Algorithms	Select the WPA Algorithms that you would like to use.
• Key Renewal Interval (Seconds)	The key renewal time is the period of time that the AP uses the same key before a new one is generated.
• Pre-Shared Key	Data encryption and key are required for wireless authentication.

5.6.1.3. Wireless Mode – WDS Repeater

Basic Wireless Settings

Wireless Mode: WDS Repeater

Root AP MAC Address (optional):

Country Code: United States [Set Country Code](#)

Frequency (Channel): 5180 MHz (Channel 36)

Site Survey: [Site Survey](#)

Network Mode: WiFi 11na HT20

Extension Channel: None

Distance: 0.6 miles (1.0 km)

ACK/CTS Timeout: 41

SSID I Security Settings

Network Name (SSID): WNAP-7320 [Hide](#)

Encryption Settings: WPA2-PSK

WPA Algorithms: TKIP CCMP(AES) Auto

Key Renewal Interval(Seconds): 60

Pre-Shared Key: 12345678 [Generator](#)

[Apply](#) [Cancel](#)

SSID II Security Settings

Root AP SSID: [Hide](#)

Encryption Settings: Disable

Figure 5-6-3

The page includes the following fields:

Object	Description
<ul style="list-style-type: none"> Wireless Mode 	<p>Click to select Wireless Mode from pull down menu.</p> <p>There are 4 options available:</p> <ul style="list-style-type: none"> Access Point: This mode allows wireless clients or Stations(STA) to access WDS Access Point: This mode enables the wireless interconnection of Access Point in an IEEE802.11 network .and accept wireless clients at the same time. WDS Repeater: Set to this mode to enable the wireless access point repeat the signal of root access point using WDS. WDS Client: Set to this mode to enable wireless client using WDS to connect to the WDS Access Point.
<ul style="list-style-type: none"> Root AP MAC Address (optional) 	Fill out the Root AP's MAC Address enable it to connect to the Root AP using WDS.
<ul style="list-style-type: none"> Country Code 	Set your country code by clicking the “Set Country Code”.

• Frequency (Channel)	Set the channel you would like to use. The channel range will be changed by selecting different domain.
• Site Survey	Click " Site Survey " button to observe the signal of remote sites.
• Network Mode	Select the operating channel width to WiFi 11na (mixed), HT20 or HT40MHz.
• Extension Channel	An extension channel is a secondary channel used to bond with the primary channel to increase this range to 40MHz. Bonded channels allow for greater bandwidth on the local network.
• Distance	To decrease the chances of data retransmission at long distance, the IEEE 802.11a/n Wireless Outdoor CPE can automatically adjust proper ACK timeout value by specifying distance of the two nodes.
• ACK/CTS Timeout	ACK/CTS Timeout settings are for long distance links. It is important to tweak settings to achieve the optimal result based on requirement. The device's default settings should be sufficient for most applications. The value is auto determined by distance between the radios, data rate of average environment.
• Network Name (SSID)	It is the wireless network name of itself. The SSID can be 32 bytes long. User can use the default SSID or change it. The default SSID is WNAP-7320 .
• Root AP SSID	It is the wireless network name of Root AP. The SSID must be the same with Root AP so that the connection can be established successfully.
• Encryption Settings	Select the encryption type that you would like to use.
• WPA Algorithms	Select the WPA Algorithms that you would like to use.
• Key Renewal Interval (Seconds)	The key renewal time is the period of time that the AP uses the same key before a new one is generated.
• Pre-Shared Key	Data encryption and key are required for wireless authentication.

5.6.1.4. Wireless Mode – WDS Client

Basic Wireless Settings

Wireless Mode:

Root AP MAC Address (optional):

Country Code:

Frequency (Channel):

Network Mode:

Extension Channel:

Distance: miles (1.0 km)

ACK/CTS Timeout:

SSID | Security Settings

Root AP SSID:

Encryption Settings:

WPA Algorithms: TKIP [?] CCMP(AES) Auto

Key Renewal Interval(Seconds):

Pre-Shared Key:

Figure 5-6-4

The page includes the following fields:

Object	Description
<ul style="list-style-type: none"> Wireless Mode 	<p>Click to select Wireless Mode from pull down menu.</p> <p>There are 4 options available:</p> <ul style="list-style-type: none"> Access Point: This mode allows wireless clients or Stations(STA) to access WDS Access Point: This mode enables the wireless interconnection of Access Point in an IEEE802.11 network .and accept wireless clients at the same time. WDS Repeater: Set to this mode to enable the wireless access point repeat the signal of root access point using WDS. WDS Client: Set to this mode to enable wireless client using WDS to connect to the WDS Access Point.
<ul style="list-style-type: none"> Root AP MAC Address (optional) 	Fill out the Root AP's MAC Address enable it to connect to the Root AP using WDS.
<ul style="list-style-type: none"> Country Code 	Set your country code by clicking the "Set Country Code".

• Frequency (Channel)	Set the channel you would like to use. The channel range will be changed by selecting different domain.
• Network Mode	Select the operating channel width to WiFi 11na (mixed), HT20 or HT40MHz.
• Extension Channel	An extension channel is a secondary channel used to bond with the primary channel to increase this range to 40MHz. Bonded channels allow for greater bandwidth on the local network.
• Distance	To decrease the chances of data retransmission at long distance, the IEEE 802.11a/n Wireless Outdoor CPE can automatically adjust proper ACK timeout value by specifying distance of the two nodes.
• ACK/CTS Timeout	ACK/CTS Timeout settings are for long distance links. It is important to tweak settings to achieve the optimal result based on requirement. The device's default settings should be sufficient for most applications. The value is auto determined by distance between the radios, data rate of average environment.
• Root AP SSID	It is the wireless network name of Root AP. The SSID must be the same with Root AP so that the connection can be established successfully. Click " Scan " to site survey the Root AP.
• Encryption Settings	Select the encryption type that you would like to use.
• WPA Algorithms	Select the WPA Algorithms that you would like to use.
• Key Renewal Interval (Seconds)	The key renewal time is the period of time that the AP uses the same key before a new one is generated.
• Pre-Shared Key	Data encryption and key are required for wireless authentication.

5.6.2 Profile Settings

In **Client Bridge** and **Client Router** operation modes, please go to “Advanced-> Wireless Settings-> Profile Settings” to configure the wireless client function to connect with the wireless AP.

The screenshot displays the 'Profile Settings' configuration page. At the top, there are two tabs: 'Wireless Settings' and 'Profile Settings'. Below this, the 'Currently Used Profile' section shows a table with columns for SSID, BSSID, Authentication, Encryption, and Network Type. The 'Profile List' table contains one entry for 'WNAP-7320' with BSSID '00:30:4F:60:EF:BE', Authentication 'WPA2-Personal', Encryption 'CCMP', and Network Type 'Infrastructure'. The 'Profile Setup' section includes fields for Profile Name, SSID, Encryption Settings (set to 'Disabled'), Network Type (set to 'Infrastructure'), and BSSID(optional). There is also a 'Site Survey' button. The 'Ack Timeout Settings' section includes a slider for Distance (set to 0.6 miles / 1.0 km), ACK/CTS Timeout (set to 41), RTS/CTS (checkbox), Fragmentation Threshold (checkbox), and WDS Client (checkbox). At the bottom, there are 'Activate', 'Add', and 'Delete' buttons.

Figure 5-6-5

The page includes the following fields:

Object	Description
<ul style="list-style-type: none"> Profile Name 	Fill out the Root AP's MAC Address enable it to connect to the Root AP using WDS.
<ul style="list-style-type: none"> Network Type 	<p>Set the Network Type that you would like to use.</p> <ul style="list-style-type: none"> Infrastructure: Infrastructure networks consist of the networked devices and the wireless access point or wireless router. Each device must connect to the access point before having access to other computers on the network. Ad-hoc: In an ad hoc network, each device's network adapter directly communicates with other devices.
<ul style="list-style-type: none"> SSID 	It is the wireless network name of Root AP.

• BSSID (optional)	Indicate the Basic Service Set ID of the associated AP
• Encryption Settings	Select the encryption type that you would like to use.
• Distance	To decrease the chances of data retransmission at long distance, the IEEE 802.11a/n Wireless Outdoor CPE can automatically adjust proper ACK timeout value by specifying distance of the two nodes.
• ACK/CTS Timeout	<p>ACK/CTS Timeout settings are for long distance links. It is important to tweak settings to achieve the optimal result based on requirement. The device's default settings should be sufficient for most applications.</p> <p>The value is auto determined by distance between the radios, data rate of average environment.</p>
• RTS/CTS	<p>RTS/CTS (Request to Send / Clear to Send) is the optional mechanism used by the 802.11 wireless networking protocol to reduce frame collisions introduced by the hidden node problem.</p> <p>You can enter a setting ranging from 0 to 2347 bytes.</p>
• Fragmentation Threshold	The fragmentation threshold determines the size at which packets are fragmented (sent as several pieces instead of as one block). Use a low setting in areas where communication is poor or where there is a great deal of radio interference. This function will help you to improve the network performance.
• WDS Client	Check it to enable WDS Client function.

5.6.3 Advanced

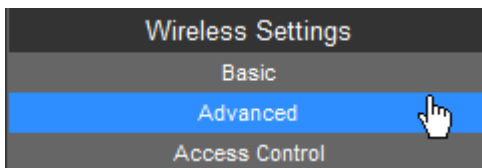

Advanced Wireless Settings

Wireless On/Off

AP MAC Address 00:30:4F:60:EF:BE

Packet Aggregate Enable Disable

WMM Enable Disable

TX Power dBm

Beacon Interval ms

DTIM

RTS/CTS Bytes

Fragmentation Threshold Bytes

Station Control (SSID I)

Station Control (SSID II)

Wireless Isolate

Thresholds,dbm LED1:- LED2:- LED3:- LED4:-

Figure 5-6-6

The page includes the following fields:

Object	Description
• Wireless On/Off	Click this button to switch the Wireless Radio On or Off.
• AP MAC Address	Display the AP MAC Address of wireless interface.
• Packet Aggregate	In a packet-based communications network, packet aggregation is the process of joining multiple packets together into a single transmission unit, in order to reduce the overhead associated with each transmission.
• WMM	WMM function can guarantee the packets with high-priority messages being transmitted preferentially. It is strongly recommended enabled.
• TX Power	The range of TX power is “3~27dBm”. In case of shortening the distance and the coverage of the wireless network, input a smaller value to reduce the radio transmission power. For example, input

	9 to apply 33% Tx power.
• Beacon Interval	The beacons are the packets sent by the Device to synchronize a wireless network. Beacon Interval value determines the time interval of the beacons. You can specify a value between 20-1000 milliseconds. The default value is 100 .
• DTIM	This value determines the interval of the Delivery Traffic Indication Message (DTIM). You can specify the value between 1-255 Beacon Intervals. The default value is 1 , which indicates the DTIM Interval is the same as Beacon Interval.
• RTS/CTS	The RTS/CTS mechanism is widely used in wireless networks in order to avoid packet collisions and, thus, achieve high throughput.
• Fragmentation Threshold	This value is the maximum size determining whether packets will be fragmented. Setting the Fragmentation Threshold too low may result in poor network performance since excessive packets. 2346 is the default setting and is recommended.
• Station Control (SSID I)	Fill out the Station Control value of SSID I.
• Station Control (SSID II)	Fill out the Station Control value of SSID II.
• Wireless Isolate	Isolate all connected wireless stations so that wireless stations cannot access each other through WLAN. This function will be disabled if WDS/Bridge is enabled.
• Thresholds, dbm	Set the AP to the external LED lights and wireless signal strength received correspondence, when the AP receives the wireless signal, according to the wireless signal strength, the corresponding LED will be lit.

5.6.4 Access Control

Choose menu “**Advanced-> Wireless Settings-> Access Control**” to configure the filtering rules for the clients would like to associate with Wireless AP.

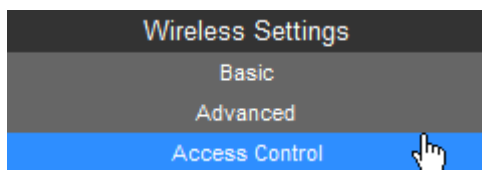

The screenshot shows the configuration interface for the WNAP-7320. It is divided into three main sections:

- Basic Settings:** Contains a dropdown menu for SSID set to 'WNAP-7320' and another dropdown for Access Control Mode set to 'Allow Listed'. Below these are 'Apply' and 'Reset' buttons.
- Wireless Access Control:** Contains a text input field for MAC Address with the value '00:30:4F:60:EF:AE' and a note '(content filter message 32.)'. Below are 'Apply' and 'Reset' buttons.
- Current Access Control List:** A table with columns 'No.', 'Action', and 'MAC Address'. It contains one entry with 'No.' 1, 'Action' ALLOW, and 'MAC Address' 00:30:4F:60:EF:AE. Below the table are 'Delete' and 'Reset' buttons.

Figure 5-6-7

The page includes the following fields:

Object	Description
• SSID	Select the SSID which you would like to configure access control.
• Access Control Mode	Allow Listed: allow the packets not specified by any access control policy to pass through the AP Router. Deny Listed: deny the packets not specified by any access control policy to pass through the AP Router.
• MAC Address	Configure the MAC Address to apply the access control.
• Current Access Control List	Display the current Access Control List.

5.7 Logout

Select “Logout”, and then click “Yes” to logout the system.



Figure 5-7-1

The dialog box has a title bar that says 'Logout'. The main content area contains the question 'Do you want to logout?' and a single 'Yes' button below it.

Figure 5-7-2

Appendix A: FAQ

A.1 What and how to find my PC's IP and MAC address?

IP address is the identifier for a computer or device on a TCP/IP network. Networks using the TCP/IP protocol route messages based on the IP address of the destination. The format of an IP address is a 32-bit numeric address written as four numbers separated by periods. Each number can be zero to 255. For example, 191.168.1.254 could be an IP address

The MAC (Media Access Control) address is your computer's unique hardware number. (On an Ethernet LAN, it's the same as your Ethernet address.) When you're connected to the Internet from your computer (or host as the Internet protocol thinks of it), a correspondence table relates your IP address to your computer's physical (MAC) address on the LAN.

To find your PC's IP and MAC address,

- (1) Open the Command program in the Microsoft Windows.
- (2) Type in "ipconfig /all", then press the Enter button.
- (3) Your PC's IP address is the one entitled IP Address and your PC's MAC address is the one entitled Physical Address.

A.2 What is Wireless LAN?

A wireless LAN (WLAN) is a network that allows access to Internet without the need for any wired connections to the user's machine.

A.3 What are ISM bands?

ISM stands for Industrial, Scientific and Medical; radio frequency bands that the Federal Communications Commission (FCC) authorized for wireless LANs. The ISM bands are located at 915 +/-13 MHz, 2450 +/-50 MHz and 5800 +/-75 MHz.

A.4 How does wireless networking work?

The 802.11 standard define two modes: infrastructure mode and ad hoc mode. In infrastructure mode, the wireless network consists of at least one access point connected to the wired network infrastructure and a set of wireless end stations. This configuration is called a Basic Service Set (BSS). An Extended Service Set (ESS) is a set of two or more BSSs forming a single sub-network. Since most corporate WLANs require access to the wired LAN for services (file servers, printers, Internet links) they will operate in infrastructure mode.

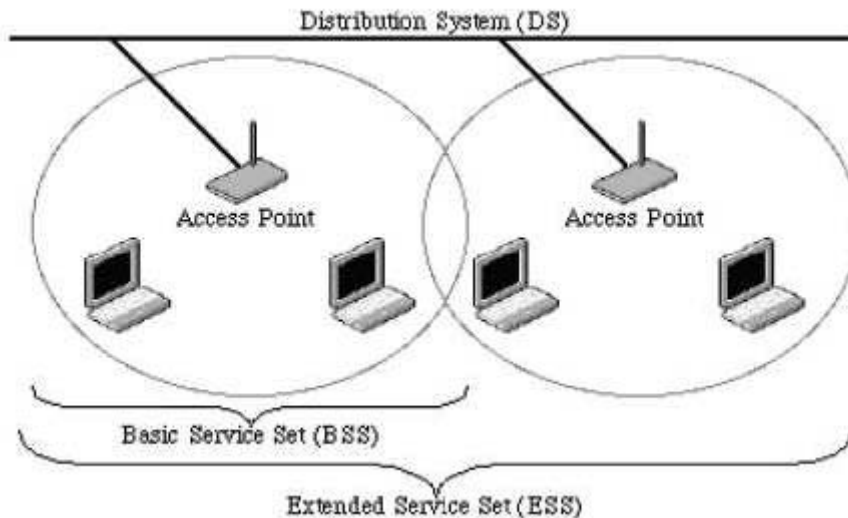

Example 1: wireless Infrastructure Mode

Ad hoc mode (also called peer-to-peer mode or an Independent Basic Service Set, or IBSS) is simply a set of 802.11 wireless stations that communicate directly with one another without using an access point or any connection to a wired network. This mode is useful for quickly and easily setting up a wireless network anywhere that a wireless infrastructure does not exist or is not required for services, such as a hotel room, convention center, or airport, or where access to the wired network is barred (such as for consultants at a client site).

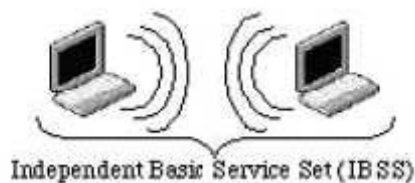

Example 2: wireless Ad Hoc Mode

A.5 What is BSSID?

A six-byte address is that distinguish a particular a particular access point from others. Also know as just SSID. Serve as a network ID or name.

A.6 What is ESSID?

The Extended Service Set ID (ESSID) is the name of the network you want to access. It is used to identify different wireless networks.

A.7 What are potential factors that may causes interference?

Factors of interference:

- Obstacles: walls, ceilings, furniture... etc.
- Building Materials: metal door, aluminum studs.
- Electrical devices: microwaves, monitors and electrical motors.

Solutions to overcome the interferences:

- Minimizing the number of walls and ceilings.
- Position the WLAN antenna for best reception.
- Keep WLAN devices away from other electrical devices, eg: microwaves, monitors, electric motors...etc.
- Add additional WLAN Access Points if necessary.

A.8 What are the Open System and Shared Key authentications?

IEEE 802.11 supports two subtypes of network authentication services: open system and shared key. Under open system authentication, any wireless station can request authentication. The station that needs to authenticate with another wireless station sends an authentication management frame that contains the identity of the sending station. The receiving station then returns a frame that indicates whether it recognizes the sending station. Under shared key authentication, each wireless station is assumed to have received a secret shared key over a secure channel that is independent from the 802.11 wireless network communications channel.

A.9 What is WEP?

An option of IEEE 802.11 function is that offers frame transmission privacy similar to a wired network. The Wired Equivalent Privacy generates secret shared encryption keys that both source and destination stations can use to alert frame bits to avoid disclosure to eavesdroppers.

WEP relies on a secret key that is shared between a mobile station (e.g. a laptop with a wireless Ethernet card) and an access point (i.e. a base station). The secret key is used to encrypt packets before they are transmitted, and an integrity check is used to ensure that packets are not modified in transit.

A.10 What is Fragment Threshold?

The proposed protocol uses the frame fragmentation mechanism defined in IEEE 802.11 to achieve parallel transmissions. A large data frame is fragmented into several fragments each of size equal to fragment threshold. By tuning the fragment threshold value, we can get varying fragment sizes. The determination of an efficient fragment threshold is an important issue in this scheme. If the fragment threshold is small, the overlap part of the master and parallel transmissions is large. This means the spatial reuse ratio of parallel transmissions is high. In contrast, with a large fragment threshold, the overlap is small and the spatial reuse ratio is low. However high fragment threshold leads to low fragment overhead. Hence there is a trade-off between spatial re-use and fragment overhead.

Fragment threshold is the maximum packet size used for fragmentation. Packets larger than the size programmed in this field will be fragmented.

If you find that your corrupted packets or asymmetric packet reception (all send packets, for example). You may want to try lowering your fragmentation threshold. This will cause packets to be broken into smaller fragments.

These small fragments, if corrupted, can be resent faster than a larger fragment. Fragmentation increases overhead, so you'll want to keep this value as close to the maximum value as possible.

A.11 What is RTS (Request to Send) Threshold?

The RTS threshold is the packet size at which packet transmission is governed by the RTS/CTS transaction. The IEEE 802.11-1997 standard allows for short packets to be transmitted without RTS/ CTS transactions. Each station can have a different RTS threshold. RTS/CTS is used when the data packet size exceeds the defined RTS threshold. With the CSMA/CA transmission mechanism, the transmitting station sends out an RTS packet to the receiving station, and waits for the receiving station to send back a CTS (Clear to Send) packet before sending the actual packet data.

This setting is useful for networks with many clients. With many clients, and a high network load, there will be many more collisions. By lowering the RTS threshold, there may be fewer collisions, and performance should improve. Basically, with a faster RTS threshold, the system can recover from problems faster. RTS packets consume valuable bandwidth, however, so setting this value too low will limit performance.

A.12 What is Beacon Interval?

In addition to data frames that carry information from higher layers, 802.11 include management and control frames that support data transfer. The beacon frame, which is a type of management frame, provides the "heartbeat" of a wireless LAN, enabling stations to establish and maintain communications in an orderly fashion.

Beacon Interval represents the amount of time between beacon transmissions. Before a station enters power save mode, the station needs the beacon interval to know when to wake up to receive the beacon (and learn whether there are buffered frames at the access point).

A.13 What is Preamble Type?

There are two preamble types defined in IEEE 802.11 specification. A long preamble basically gives the decoder more time to process the preamble. All 802.11 devices support a long preamble. The short preamble is designed to improve efficiency (for example, for VoIP systems). The difference between the two is in the Synchronization field. The long preamble is 128 bits, and the short is 56 bits.

A.14 What is SSID Broadcast?

Broadcast of SSID is done in access points by the beacon. This announces your access point (including various bits of information about it) to the wireless world around it. By disabling that feature, the SSID configured in the client must match the SSID of the access point.

Some wireless devices don't work properly if SSID isn't broadcast (for example the D-link DWL-120 USB 802.11b adapter). Generally if your client hardware supports operation with SSID disabled, it's not a bad idea to run that way to enhance network security. However it's no replacement for WEP, MAC filtering or other protections.

A.15 What is Wi-Fi Protected Access (WPA)?

Wi-Fi's original security mechanism, Wired Equivalent Privacy (WEP), has been viewed as insufficient for securing confidential business communications. A longer-term solution, the IEEE 802.11i standard, is under development. However, since the IEEE 802.11i standard is not expected to be published until the end of 2003, several members of the Wi-Fi Alliance teamed up with members of the IEEE 802.11i task group to develop a significant near-term enhancement to Wi-Fi security. Together, this team developed Wi-Fi Protected Access.

To upgrade a WLAN network to support WPA, Access Points will require a WPA software upgrade. Clients will require a software upgrade for the network interface card, and possibly a software update for the operating system. For enterprise networks, an authentication server, typically one that supports RADIUS and the selected EAP authentication protocol, will be added to the network.

A.16 What is WPA2?

It is the second generation of WPA. WPA2 is based on the final IEEE 802.11i amendment to the 802.11 standard.

A.17 What is 802.1x Authentication?

802.1x is a framework for authenticated MAC-level access control, defines Extensible Authentication Protocol (EAP) over LANs (WAPOL). The standard encapsulates and leverages much of EAP, which was defined for dial-up authentication with Point-to-Point Protocol in RFC 2284.

Beyond encapsulating EAP packets, the 802.1x standard also defines EAPOL messages that convey the shared key information critical for wireless security.

A.18 What is Temporal Key Integrity Protocol (TKIP)?

The Temporal Key Integrity Protocol, pronounced tee-kip, is part of the IEEE 802.11i encryption standard for wireless LANs. TKIP is the next generation of WEP, the Wired Equivalency Protocol, which is used to secure 802.11 wireless LANs. TKIP provides per-packet key mixing, a message integrity check and a re-keying mechanism, thus fixing the flaws of WEP.

A.19 What is Advanced Encryption Standard (AES)?

Security issues are a major concern for wireless LANs, AES is the U.S. government's next-generation cryptography algorithm, which will replace DES and 3DES.

A.20 What is Inter-Access Point Protocol (IAPP)?

The IEEE 802.11f Inter-Access Point Protocol (IAPP) supports Access Point Vendor interoperability, enabling roaming of 802.11 Stations within IP subnet.

IAPP defines messages and data to be exchanged between Access Points and between the IAPP and high layer management entities to support roaming. The IAPP protocol uses TCP for inter-Access Point communication and UDP for RADIUS request/response exchanges. It also uses Layer 2 frames to update the forwarding tables of Layer 2 devices.

A.21 What is Wireless Distribution System (WDS)?

The Wireless Distribution System feature allows WLAN AP to talk directly to other APs via wireless channel, like the wireless WDS or repeater service.

A.22 What is Universal Plug and Play (UPnP)?

UPnP is an open networking architecture that consists of services, devices, and control points. The ultimate goal is to allow data communication among all UPnP devices regardless of media, operating system, programming language, and wired/wireless connection.

A.23 What is Maximum Transmission Unit (MTU) Size?

Maximum Transmission Unit (MTU) indicates the network stack of any packet is larger than this value will be fragmented before the transmission. During the PPP negotiation, the peer of the PPP connection will indicate its MRU and will be accepted. The actual MTU of the PPP connection will be set to the smaller one of MTU and the peer's MRU.

A.24 What is Clone MAC Address?

Clone MAC address is designed for your special application that request the clients to register to a server machine with one identified MAC address. Since that all the clients will communicate outside world through the WLAN Broadband Router, so have the cloned MAC address set on the WLAN Broadband Router will solve the issue.

A.25 What is DDNS?

DDNS is the abbreviation of Dynamic Domain Name Server. It is designed for user owned the DNS server with dynamic WAN IP address.

A.26 What is NTP Client?

NTP client is designed for fetching the current timestamp from internet via Network Time protocol. User can specify time zone, NTP server IP address.

A.27 What is VPN?

VPN is the abbreviation of Virtual Private Network. It is designed for creating point-to point private link via shared or public network.

A.28 What is IPSEC?

IPSEC is the abbreviation of IP Security. It is used to transferring data securely under VPN.

A.29 What is WLAN Block Relay between Clients?

An Infrastructure Basic Service Set is a BSS with a component called an Access Point (AP). The access point provides a local relay function for the BSS. All stations in the BSS communicate with the access point and no longer communicate directly. All frames are relayed between stations by the access point. This local relay function effectively doubles the range of the IBSS.

A.30 What is WMM?

WMM is based on a subset of the IEEE 802.11e WLAN QoS draft standard. WMM adds prioritized capabilities to Wi-Fi networks and optimizes their performance when multiple concurring applications, each with different latency and throughput requirements, compete for network resources. By using WMM, end-user satisfaction is maintained in a wider variety of environments and traffic conditions. WMM makes it possible for home network users and enterprise network managers to decide which data streams are most important and assign them a higher traffic priority.

A.31 What is WLAN ACK TIMEOUT?

ACK frame has to receive ACK timeout frame. If remote does not receive in specified period, it will be retransmitted.

A.32 What is Modulation Coding Scheme (MCS)?

MCS is Wireless link data rate for 802.11n. The throughput/range performance of an AP will depend on its implementation of coding schemes. MCS includes variables such as the number of spatial streams, modulation, and the data rate on each stream. Radios establishing and maintaining a link must automatically negotiate the optimum MCS based on channel conditions and then continuously adjust the selection of MCS as conditions change due to interference, motion, fading, and other events.

A.33 What is Frame Aggregation?

Every 802.11 packet, no matter how small, has a fixed amount of overhead associated with it. Frame Aggregation combines multiple smaller packets together to form one larger packet. The larger packet can be sent without the overhead of the individual packets. This technique helps improve the efficiency of the 802.11n radio allowing more end user data to be sent in a given time.

A.34 What is Guard Intervals (GI)?

A GI is a period of time between symbol transmission that allows reflections (from multipath) from the previous data transmission to settle before transmitting a new symbol. The 802.11n specifies two guard intervals: 400ns (short) and 800ns (long). Support of the 400ns GI is optional for transmit and receive. The purpose of a guard interval is to introduce immunity to propagation delays, echoes, and reflections to which digital data is normally very sensitive.

Appendix B: Configuring the PC in Windows 7

In this section, we'll introduce how to configure the TCP/IP correctly in Windows 7. First make sure your Network Adapter is working, refer to the adapter's manual if needed.

- 1) On the Windows taskbar, click the **Start** button, and then click **Control Panel**.
- 2) Click the **Network and Sharing Center** icon, and then click the **Change adapter settings** on the left side of the screen.

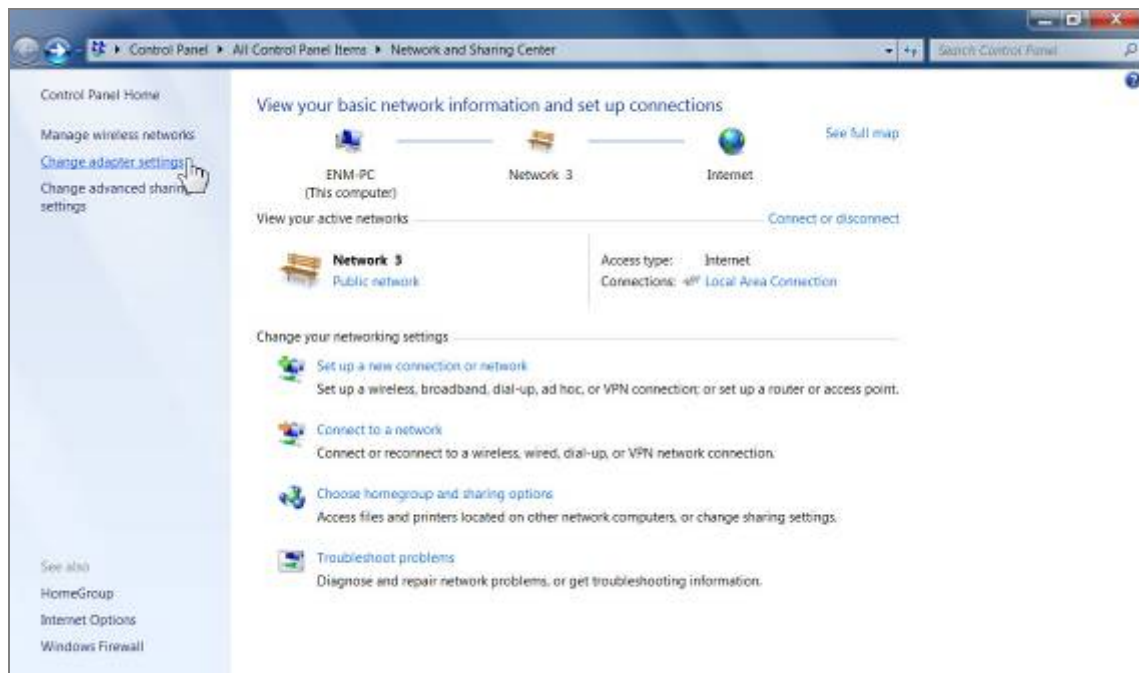

Figure B-1

- 3) Right click the icon of the network adapter shown in the figure below, and select Properties on the prompt window.

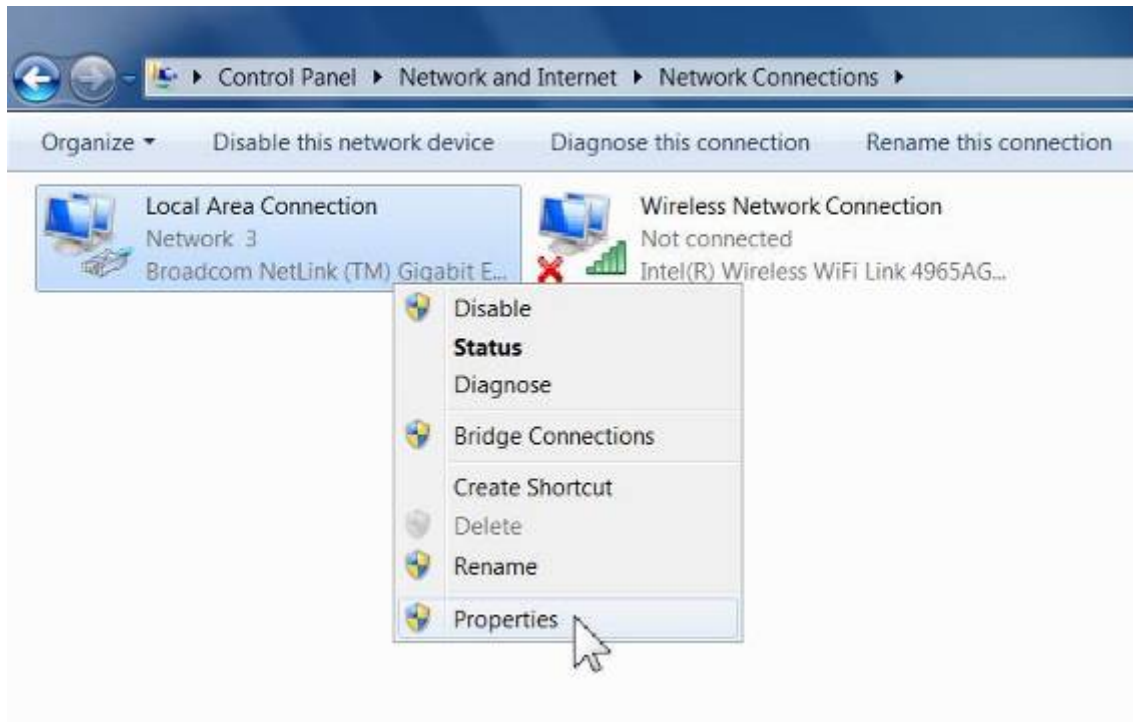

Figure B-2

- 4) In the prompt page shown below, double click on the **Internet Protocol Version 4 (TCP/IPv4)**.

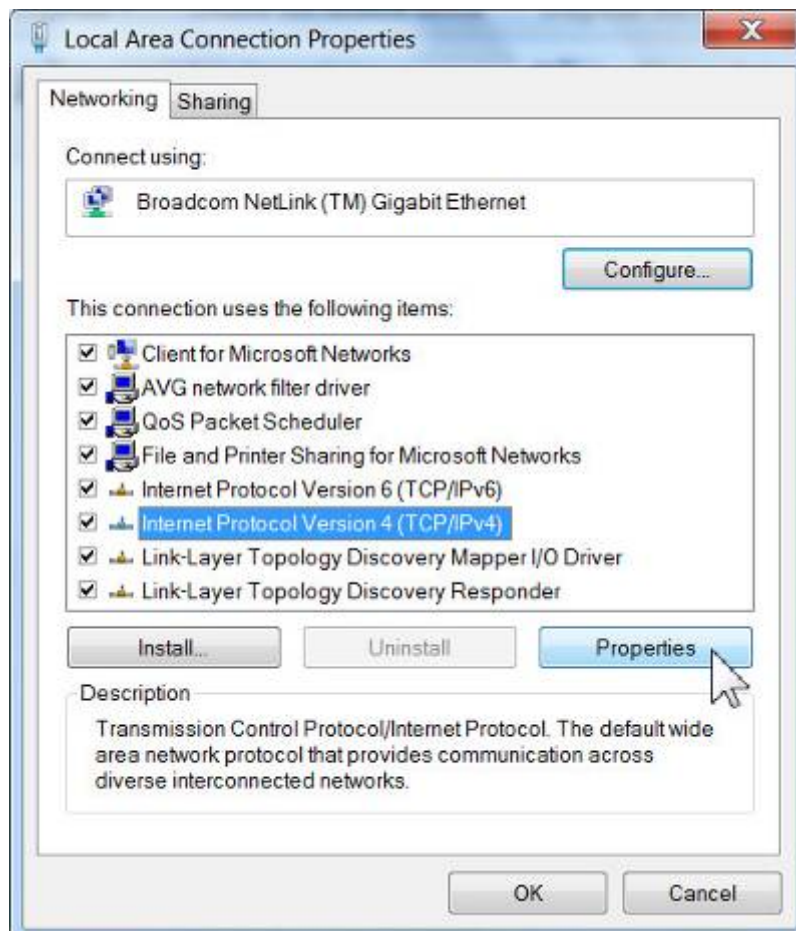

Figure B-3

- 5) The following **TCP/IP Properties** window will display and the **IP Address** tab is open on this window by default.

Now you can configure the **TCP/IP** protocol below:

➤ **Setting IP address manually**

- 1 Select **Use the following IP address** radio button.
- 2 If the AP's LAN IP address is 192.168.1.1, type in IP address 192.168.1.x (x is from 2 to 254), and **Subnet mask** 255.255.255.0.
- 3 Select **Use the following DNS server addresses** radio button. In the **Preferred DNS Server** field you can type the DNS server IP address which has been provided by your ISP

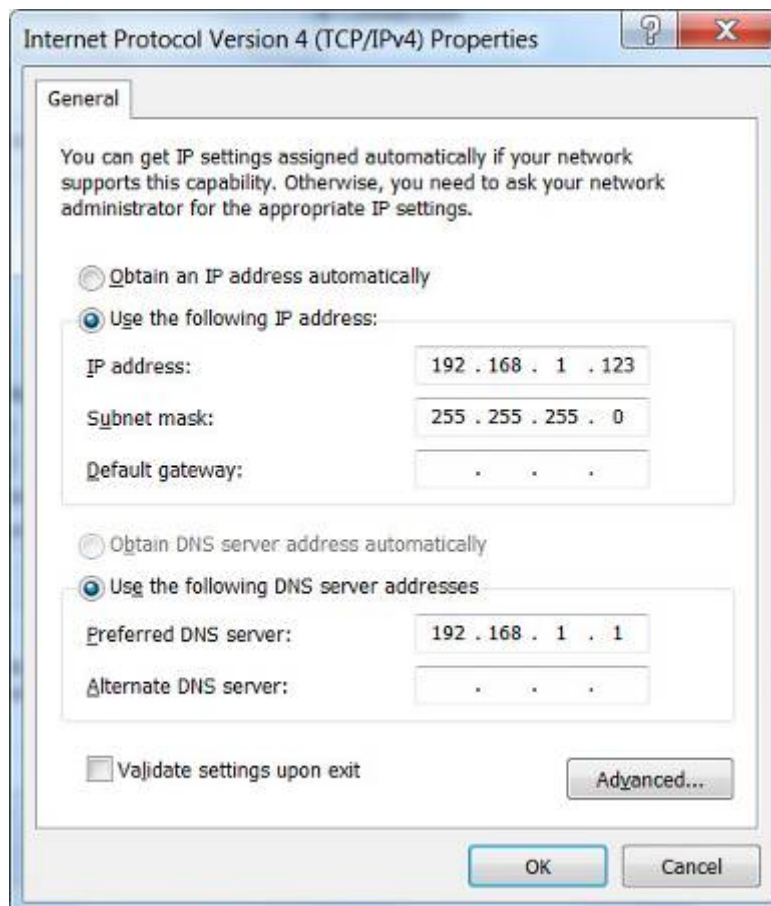

Figure B-4

Now click **OK** to keep your settings.

Appendix C: Use Planet Smart Discovery to find AP

For easily discover the WNAP-7320 in your Ethernet environment, the Planet Smart Discovery Utility from user's manual CD-ROM is an ideal solution.

The following install instructions guiding you to run the Planet Smart Discovery Utility.

Step 1: Deposit the **Planet Smart Discovery Utility** in administrator PC.

Step 2: Execute this utility.



Step 3: Click **“Refresh”** button to update the current connected devices list, the screen is shown as follow.

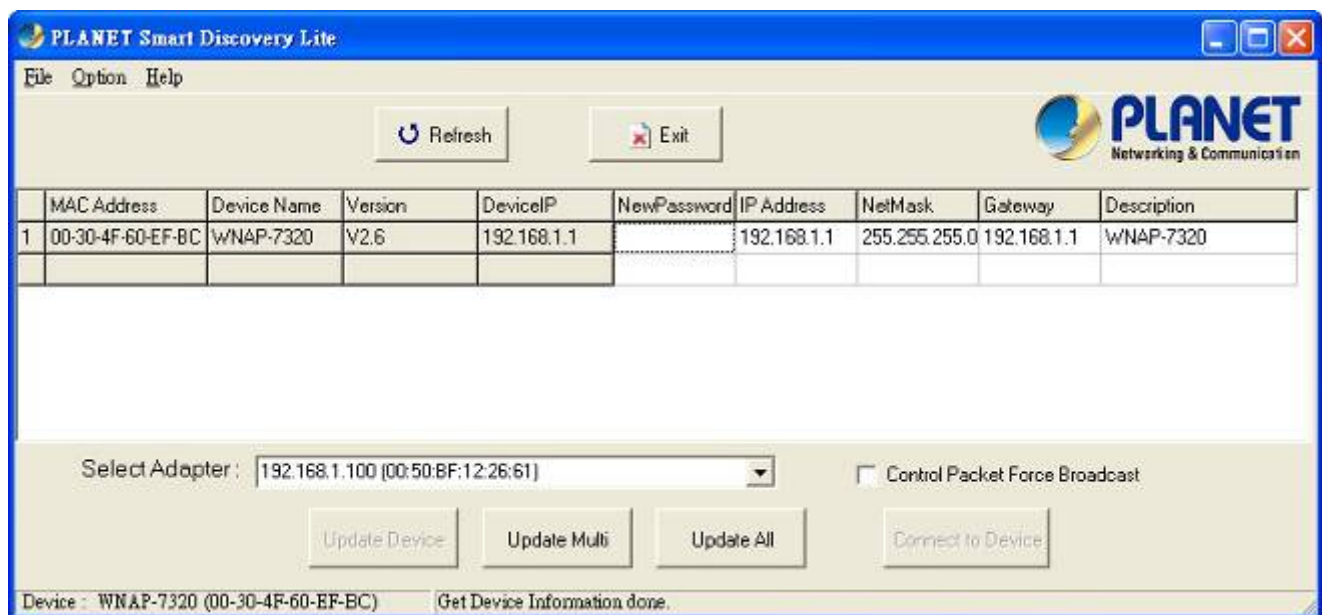

Figure C-1

Step 3: Select the WNAP-7320 from the list, and then click **“Connect to Device”** button to login the Web Management Configuration Page.



The fields in white background can be modified directly, and then you can apply the new setting by clicking the **“Update Device”** button.

Appendix D: Specifications

Product	WNAP-7320 5GHz 300Mbps 802.11a/n Wireless Outdoor Access Point			
Hardware Specifications				
Standard support	IEEE 802.11a/n Wireless LAN IEEE 802.11i Wireless Security IEEE 802.3 10Base-T Ethernet IEEE 802.3u 100Base-TX Ethernet IEEE 802.3x Flow Control			
Memory	32 Mbytes DDR SDRAM 8 Mbytes Flash			
Interface	Wireless IEEE802.11a/n, 2T2R LAN: 1 x 10/100Base-TX, Auto-MDI/MDIX WAN: 1 x 10/100Base-TX, Auto-MDI/MDIX			
Antenna	Built-in 14dBi Dual-Polarization Antenna - Horizontal: 45 degree - Vertical: 60 degree			
Wireless RF Specifications				
Wireless Technology	IEEE 802.11a IEEE 802.11n			
Data Rate	IEEE 802.11a: 54, 48, 36, 24, 18, 12, 9 and 6Mbps IEEE 802.11n (20MHz): up to 150Mbps IEEE 802.11n (40MHz): up to 300Mbps			
Media Access Control	CSMA / CA			
Modulation	Transmission / Emission Type: OFDM Data modulation type: OFDM with BPSK, QPSK, 16-QAM, 64-QAM			
Frequency Band	5.180GHz ~ 5.825GHz			
Operating Channel	5.180GHz	CH36	5.580GHz	CH116
	5.200GHz	CH40	5.600GHz	CH120
	5.220GHz	CH44	5.620GHz	CH124
	5.240GHz	CH48	5.640GHz	CH128
	5.260GHz	CH52	5.660GHz	CH132
	5.280GHz	CH56	5.680GHz	CH136
	5.300GHz	CH60	5.700GHz	CH140
	5.320GHz	CH64	5.745GHz	CH149
	5.500GHz	CH100	5.765GHz	CH153
	5.520GHz	CH104	5.785GHz	CH157
	5.540GHz	CH108	5.805GHz	CH161
	5.560GHz	CH112	5.825GHz	CH165
*The above 24 channels are defined in theory. The actual application will vary depends on the regulation in different regions and countries.				

RF Output Power	IEEE 802.11a: 27 ± 1dBm IEEE 802.11n: 24 ± 1dBm
Receiver Sensitivity	IEEE 802.11a: -92 ~ -73dBm @ 6Mbps ~ 54Mbps IEEE 802.11n: -94 ~ -73dBm @ MCS0 ~ MCS15
Output Power Control	3~27dBm
Software Features	
LAN	Built-in DHCP server supporting static IP address distributing Supports 802.1d STP (Spanning Tree)
WAN	<ul style="list-style-type: none"> ■ Static IP ■ Dynamic IP ■ PPPoE ■ PPTP ■ L2TP ■ IPSec
Operating Mode	<ul style="list-style-type: none"> ■ Bridge ■ Gateway ■ WISP
Firewall	NAT firewall with SPI (Stateful Packet Inspection) Built-in NAT server supporting Virtual Server and DMZ Built-in firewall with Port / IP address / MAC / URL filtering
Wireless Mode	<ul style="list-style-type: none"> ■ AP ■ Client ■ WDS PTP ■ WDS PTMP ■ WDS Repeater (AP+WDS)
Channel Width	20MHz / 40MHz
Wireless Isolation	Enable it to isolate each connected wireless clients from communicating with each other mutually.
Encryption Type	64/128-bits WEP, WPA, WPA-PSK, WPA2, WPA2-PSK, 802.1X
Wireless Security	Provides wireless LAN ACL (Access Control List) filtering Wireless MAC address filtering Supports WPS (WIFI Protected Setup) Enable / Disable SSID Broadcast
Multiple SSID	Up to 2
Max. Wireless Client	40
Max. WDS AP	8
Max. Wired Client	60
WMM	Supports Wi-Fi Multimedia
QoS	Supports Quality of Service for bandwidth control
NTP	Network Time Management
Management	Web UI, DHCP Client, Configuration Backup & Restore, Dynamic DNS, SNMP
Diagnostic tool	System Log, Ping Watchdog
Mechanical & Power	

IP Rate	IP55	
Material	Outdoor UV Stabilized Enclosure	
Dimension (W x D x H)	275 x 93 x 45mm	
Weight	336 ± 5g	
Installation	Pole mounting or Wall mounting	
Power Requirements	LAN	24V DC, 0.5A/ Passive PoE Pin 4,5 VDC+ Pin 7,8 VDC-
Power Consumption	7.68W	
Environment & Certification		
Operation Temperature	-30~75 Degree C	
Operating Humidity	10~95% non-condensing	
Regulatory	CE / RoHS	
Accessory		
Standard Accessories	<ul style="list-style-type: none"> ■ 24V DC Passive PoE injector & Power cord x 1 ■ Mounting Tie x 2 ■ Quick Installation Guide x 1 ■ CD (User's Manual, Quick Installation Guide) x 1 	



EC Declaration of Conformity

For the following equipment:

*Type of Product : 5GHz 802.11a/n 300Mbps Wireless LAN Outdoor CPE
AP/Router (14dBi Antenna Built-in)

*Model Number : WNAP-7320

* Produced by:

Manufacturer's Name : **Planet Technology Corp.**

Manufacturer's Address: 10F., No.96, Minquan Rd., Xindian Dist.,
New Taipei City 231, Taiwan (R.O.C.)

is herewith confirmed to comply with the requirements set out in the Council Directive on the Approximation of the Laws of the Member States relating to 1999/5/EC R&TTE. For the evaluation regarding the R&TTE the following standards were applied:

EN 301 893 V1.5.1	(2008-12)
EN 301 489-1 V1.8.1	(2008-04)
EN 301 489-17 V2.1.1	(2009-05)
EN 60950-1	(2006 + A11: 2009 + A1:2010 + A12:2011)

Responsible for marking this declaration if the:

Manufacturer **Authorized representative established within the EU**

Authorized representative established within the EU (if applicable):

Company Name: Planet Technology Corp.

Company Address: 10F., No.96, Minquan Rd., Xindian Dist., New Taipei City 231, Taiwan (R.O.C.)

Person responsible for making this declaration

Name, Surname Kent Kang

Position / Title : Product Manager

Taiwan
Place

8th March., 2013
Date

Kent Kang
Legal Signature

PLANET TECHNOLOGY CORPORATION

e-mail: sales@planet.com.tw http://www.planet.com.tw

10F., No.96, Minquan Rd., Xindian Dist., New Taipei City, Taiwan, R.O.C. Tel:886-2-2219-9518 Fax:886-2-2219-9528

EC Declaration of Conformity

English	Hereby, PLANET Technology Corporation , declares that this 300Mbps 802.11a/n Wireless Outdoor AP/Router is in compliance with the essential requirements and other relevant provisions of Directive 1999/5/EC.	Lietuviškai	Šiuo PLANET Technology Corporation , skelbia, kad 300Mbps 802.11a/n Wireless Outdoor AP/Router tenkina visus svarbiausius 1999/5/EC direktyvos reikalavimus ir kitas svarbias nuostatas.
Česky	Společnost PLANET Technology Corporation , tímto prohlašuje, že tato 300Mbps 802.11a/n Wireless Outdoor AP/Router splňuje základní požadavky a další příslušná ustanovení směrnice 1999/5/EC.	Magyar	A gyártó PLANET Technology Corporation , kijelenti, hogy ez a 300Mbps 802.11a/n Wireless Outdoor AP/Router megfelel az 1999/5/EK irányelv alapkövetelményeinek és a kapcsolódó rendelkezéseknek.
Dansk	PLANET Technology Corporation , erklærer herved, at følgende udstyr 300Mbps 802.11a/n Wireless Outdoor AP/Router overholder de væsentlige krav og øvrige relevante krav i direktiv 1999/5/EF	Malti	Hawnhekk, PLANET Technology Corporation , jiddikjara li dan 300Mbps 802.11a/n Wireless Outdoor AP/Router jikkonforma mal-htigijiet essenzjali u ma provvedimenti oħrajn relevanti li hemm fid-Dirrettiva 1999/5/EC
Deutsch	Hiermit erklärt PLANET Technology Corporation , dass sich dieses Gerät 300Mbps 802.11a/n Wireless Outdoor AP/Router in Übereinstimmung mit den grundlegenden Anforderungen und den anderen relevanten Vorschriften der Richtlinie 1999/5/EG befindet". (BMW i)	Nederlands	Hierbij verklaart, PLANET Technology Corporation , dat 300Mbps 802.11a/n Wireless Outdoor AP/Router in overeenstemming is met de essentiële eisen en de andere relevante bepalingen van richtlijn 1999/5/EG
Eestikeeles	Käesolevaga kinnitab PLANET Technology Corporation , et see 300Mbps 802.11a/n Wireless Outdoor AP/Router vastab Euroopa Nõukogu direktiivi 1999/5/EC põhinõuetele ja muudele olulistele tingimustele.	Polski	Niniejszym firma PLANET Technology Corporation , oświadcza, że 300Mbps 802.11a/n Wireless Outdoor AP/Router spełnia wszystkie istotne wymogi i klauzule zawarte w dokumencie „Directive 1999/5/EC”.
Ελληνικά	<i>ΜΕ ΤΗΝ ΠΑΡΟΥΣΑ, PLANET Technology Corporation, ΔΗΛΩΝΕΙ ΟΤΙ ΑΥΤΟ 300Mbps 802.11a/n Wireless Outdoor AP/Router ΣΥΜΜΟΡΦΩΝΕΤΑΙ ΠΡΟΣ ΤΙΣ ΟΥΣΙΩΔΕΙΣ ΑΠΑΙΤΗΣΕΙΣ ΚΑΙ ΤΙΣ ΛΟΙΠΕΣ ΣΧΕΤΙΚΕΣ ΔΙΑΤΑΞΕΙΣ ΤΗΣ ΟΔΗΓΙΑΣ 1999/5/ΕΚ</i>	Português	PLANET Technology Corporation , declara que este 300Mbps 802.11a/n Wireless Outdoor AP/Router está conforme com os requisitos essenciais e outras disposições da Directiva 1999/5/CE.
Español	Por medio de la presente, PLANET Technology Corporation , declara que 300Mbps 802.11a/n Wireless Outdoor AP/Router cumple con los requisitos esenciales y cualesquiera otras disposiciones aplicables o exigibles de la Directiva 1999/5/CE	Slovensky	Výrobca PLANET Technology Corporation , týmto deklaruje, že táto 300Mbps 802.11a/n Wireless Outdoor AP/Router je v súlade so základnými požiadavkami a ďalšími relevantnými predpismi smernice 1999/5/EC.
Français	Par la présente, PLANET Technology Corporation , déclare que les appareils du 300Mbps 802.11a/n Wireless Outdoor AP/Router sont conformes aux exigences essentielles et aux autres dispositions pertinentes de la directive 1999/5/CE	Slovensko	PLANET Technology Corporation , s tem potrjuje, da je ta 300Mbps 802.11a/n Wireless Outdoor AP/Router skladen/a z osnovnimi zahtevami in ustreznimi določili Direktive 1999/5/EC.
Italiano	Con la presente, PLANET Technology Corporation , dichiara che questo 300Mbps 802.11a/n Wireless Outdoor AP/Router è conforme ai requisiti essenziali ed alle altre disposizioni pertinenti stabilite dalla direttiva 1999/5/CE.	Suomi	PLANET Technology Corporation , vakuuttaa täten että 300Mbps 802.11a/n Wireless Outdoor AP/Router tyyppinen laite on direktiivin 1999/5/EY oleellisten vaatimusten ja sitä koskevien direktiivin muiden ehtojen mukainen.
Latviski	Ar šo PLANET Technology Corporation , apliecina, ka šī 300Mbps 802.11a/n Wireless Outdoor AP/Router atbilst Direktīvas 1999/5/EK pamatprasībām un citiem atbilstošiem noteikumiem.	Svenska	Härmed intygat, PLANET Technology Corporation , att denna 300Mbps 802.11a/n Wireless Outdoor AP/Router står i överensstämmelse med de väsentliga egenskapskrav och övriga relevanta bestämmelser som framgår av direktiv 1999/5/EG.