



## 1. Package Contents

Thank you for purchasing PLANET 1-port Ultra PoE+ to 4-port IEEE 802.3af/at Gigabit PoE Extender, POE-E304. "Gigabit PoE Extender" mentioned in this manual refers to the POE-E304.

Open the box of the Gigabit PoE Extender and carefully unpack it. The box should contain the following items:

Gigabit PoE Extender x 1	User's Manual x 1
	
Rubber Feet x 4	Wall-mount Kit
	

If any of these are missing or damaged, please contact your dealer immediately; if possible, retain the carton including the original packing material, and use them again to repack the product in case there is a need to return it to us for repair.

## 2. Product Features

### Physical Port

- 5-port 10/100/1000BASE-T Gigabit RJ45 interface
  - 1-port data + power input
  - 4-port data + power output

### Power over Ethernet

- 1-port data + power input
  - Complies with Ultra Power over Ethernet end-span/mid-span PD
  - Supports PoE input power up to 60 watts
- 4-port data + power output
  - Complies with IEEE 802.3af/IEEE 802.3at Power over Ethernet/end-span PSE
  - Up to 4 IEEE 802.3af/802.3at devices powered
  - Supports PoE power up to 30.8 watts for each PoE port
  - Auto detects powered device (PD)
- Extends the range of PoE to an additional 100 meters (328ft.)
- Forwards both Ethernet data and PoE power to remote device

### Layer 2 Features

- Hardware based 10/100/1000Mbps auto-negotiation and auto MDI/MDI-X
- Integrates address look-up engine, supporting 2K absolute MAC addresses
- 9K Jumbo packet support
- IEEE 802.1Q VLAN transparency

- Features Store-and-Forward mode with wire-speed filtering and forwarding rates
- IEEE 802.3x flow control for full duplex operation and backpressure for half duplex operation
- Automatic address learning and address aging

### Case and Installation

- No external power cable installation required
- Made of metal, desktop size design
- Wall-mountable, Plug-and-Play installation
- 0 ~ 50 degrees C operating Temperature

**Note**

**PSE (Power Sourcing Equipment)** is a device (switch or hub for instance) that will provide power in a PoE setup. The maximum allowed continuous output power per such device in IEEE 802.3af is 15.4 watts and in IEEE 802.3at is 30 watts.

**PD (Powered Device)** such as IP phones, network cameras or wireless access points is a PoE-enabled terminal that consumes energy supplied by PSE.

## 3. Product Specifications

Model	POE-E304
Hardware Specifications	
Network Connector	<b>PoE In Port</b> 1 x 10/100/1000BASE-T Ethernet with Ultra PoE b in, auto MDI/MDI-X, auto-negotiation RJ45 connector <b>PoE Out Port</b> 4 x 10/100/1000BASE-T Ethernet with IEEE 802.3at/802.3af PoE "Data + DC" out, auto MDI/MDI-X, auto-negotiation RJ45 connector
Data Rate	10/100/1000Mbps
Switch Architecture	Store-and-Forward
MAC Address Table	2K
Data Buffer	2Mbits
Switch Fabric	10Gbps
Switch Throughput	7.44Mpps @ 64 bytes
Jumbo Frame	9K
Flow Control	IEEE 802.3x pause frame for full duplex Back pressure for half duplex
LED Indicators	PoE In Port 10/100 LNK/ACT (orange), 1000 LNK/ACT (green) PoE Out Port 1 to Port 4 10/100 LNK/ACT (orange), 1000 LNK/ACT (green) PoE-in-Use (orange) PoE Max. (orange)

Protection	ESD (Ethernet): 2KV (TBD) Surge (EFT for power): 2KV (TBD)
Enclosure	Metal
Installation	Desktop/Wall mountable
Dimensions (W x D x H)	160 x 92.5 x 28mm
Weight	370g
Power Requirements	PoE In: IEEE 802.3bt or 4-pair 802.3at PoE+ compliant with voltage within 50V-56V DC External DC: 50~56V DC
Power Consumption	4 watts/13.7BTU (System on with PoE input) 6 watts/20.6BTU (Ethernet full loading without PoE function) 60 watts/205.9BTU (Full loading with PoE function)
Network Cable	10BASE-T: 4-pair UTP Cat5 up to 100m (328ft) 100BASE-TX: 4-pair UTP Cat5 up to 100m (328ft) 1000BASE-T: 4-pair UTP Cat5e, 6, up to 100m (328ft) EIA/TIA-568 100-ohm STP (100m, 328ft)
Power over Ethernet	
PoE Standard	<b>PoE In Port</b> Ultra Power over Ethernet end-span/mid-span PD class 4 PD <b>Per PoE Out Port</b> IEEE 802.3at Power over Ethernet Plus end-span PSE IEEE 802.3af Power over Ethernet end-span PSE

PoE Power	<b>PoE In Port</b> 50~56V DC, max. 60 watts <b>Per PoE Out Port</b> 44~55V DC, max. 30.8 watts
Power Pin Assignment	<b>PoE In Port</b> 1/2 (+), 3/6 (-); 4/5 (+), 7/8 (-) or 1/2(-), 3/6(+); 4/5(+), 7/8(-) <b>Per PoE Out Port</b> 1/2 (+), 3/6 (-), end-span (Type A)
PoE Power Budget	50 watts (max.) @ Ultra PoE input 20 watts (max.) @ IEEE 802.3at PoE+ input
Standard Conformance	
Regulatory Compliance	FCC Part 15 Class A, CE
Standard Compliance	IEEE 802.3 10BASE-T Ethernet IEEE 802.3u 100BASE-TX Fast Ethernet IEEE 802.3ab 1000BASE-T Gigabit Ethernet IEEE 802.3af Power over Ethernet IEEE 802.3at Power over Ethernet Plus IEEE 802.3x Flow Control
Environment	
Operating	Temperature: 0 ~ 50 degrees C Relative Humidity: 5 ~ 95% (non-condensing)
Storage	Temperature: -10 ~ 70 degrees C Relative Humidity: 5 ~ 95% (non-condensing)

**Note**

The maximum distance that data and power can transmit depends on the quality of the UTP cable and environment.

## 4. Hardware Introduction

### 4.1 Three-View Diagram

The three-view diagram of the Gigabit PoE Extender consists of one auto-sensing 10/100/1000BASE-T Ultra PoE In port, and four auto-sensing 10/100/1000BASE-T 802.3af/802.3at PoE Out ports. The LED Indicators are also located on the port of Gigabit PoE Extender front panel.

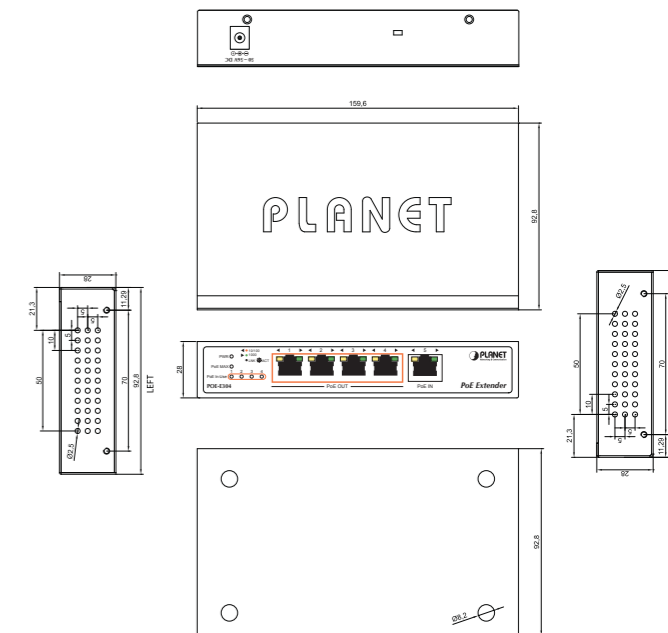

Figure 1: POE-E304

### 4.2 Ports Connection

PoE IN Port	Connect the <b>PoE IN</b> port from the following Ultra <b>PSE</b> devices through a Cat5/5e/6 UTP cable: <ul style="list-style-type: none"> <li>Ultra PoE injector</li> <li>Ultra PoE injector hub</li> <li>Ultra PoE Ethernet switch</li> </ul>
PoE OUT Port	Connect the <b>PoE OUT</b> port to the following 802.3at/af <b>PD</b> devices through a Cat5/5e/6 UTP cable: <ul style="list-style-type: none"> <li>PoE IP camera</li> <li>PoE VoIP phone</li> <li>PoE wireless AP</li> <li>PoE splitter</li> </ul>

### 4.3 LED Indicators

LED	Color	Function
10/100 LNK/ACT	Orange	<b>Lights</b> to indicate the link through that port is successfully established at 1000Mbps. <b>Blinks</b> to indicate that the port is actively sending or receiving data.
1000 LNK/ACT	Green	<b>Lights</b> to indicate the link through that port is successfully established at 1000Mbps. <b>Blinks</b> to indicate that the port is actively sending or receiving data.

## 802.3at/af PoE Out Ports

LED	Color	Function
10/100 LNK/ACT	Orange	<b>Lights</b> to indicate the link through that port is successfully established at 1000Mbps. <b>Blinks</b> to indicate that the port is actively sending or receiving data.
1000 LNK/ACT	Green	<b>Lights</b> to indicate the link through that port is successfully established at 1000Mbps. <b>Blinks</b> to indicate that the port is actively sending or receiving data.

## PoE-in-Use

LED	Color	Function
PoE Max.	Orange	<b>Lights</b> to indicate the power usage is $\geq 45W$ <b>Blinks</b> to indicate the power usage is $\geq 55W$
PoE-in-Use	Orange	<b>Lights</b> to indicate the port is providing 50V-56V DC in-line power output

## 5. Hardware Installation

### 5.1 Before Installation

The POE-E304 is installed between the PSE (Power Source Equipment) and the PD (powered device); it is powered by PSE and forwards the Ethernet data and remaining POE power or an external power supply to the PD and it can be installed easily by just plug and play without affecting the data transmission performance.

- 9 -



- To provide you with better PoE power and data extension quality, we strongly recommend that you use "Solid UTP Cable" when installing the POE-E304.
- The POE-E304 can be installed with a third-party device if the device complies with IEEE 802.3at/af standard.

### 5.2 Connecting POE-E304 to PSE

This section describes how to install Gigabit PoE Extender and make connection to it. Please read the following topics and perform the procedures in the order being presented.

There are 4 RJ45 ports in the Gigabit PoE Extender, of which the "PoE IN" port functions as "PoE (Data and Power) input" and the four "PoE Out" ports function as "PoE (Data and Power) output".

**Step 1:** Connect a standard Cat5e/6 UTP cable from power source equipment (PSE), such as PoE switch, PoE injector hub and single port PoE injector, to the "PoE IN" port of the Gigabit PoE Extender.

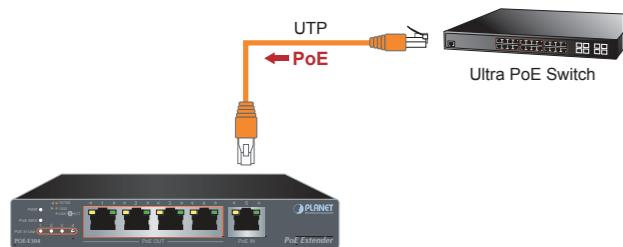

**Step 2:** The PSE delivers both Ethernet data and PoE power over UTP cable to the Gigabit PoE Extender.

- 10 -

**Note**

- When the PoE-in-use LED turns steady orange, it means the Gigabit PoE OUT is supplying power successfully from PSE.
- If the PoE-in-use LED is not lit, please check the remote PSE or the cable connecting to a PC or a network device to see if the cable is correct.

**Warning**

Never connect any **non-standard** POE PSE to the Gigabit PoE Extender; it will damage the device permanently.

### 5.3 Connecting POE-E304 to Powered Device (PD)

**Step 1:** Connect the additional Cat5e/6 cable that will be used to connect to the remote **Powered Device (PD)** to the "PoE Out" port of the Gigabit PoE Extender.

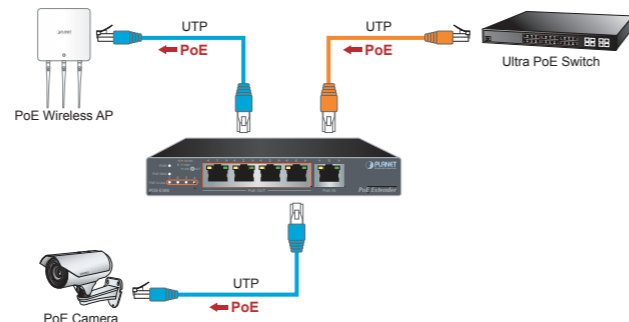

**Step 2:** The "PoE Out" port is also the power injector which transmits DC voltage to the Cat5e/6 cable and transfer data and power simultaneously between the PSE and PD.

- 11 -

**Step 3:** Once the Gigabit PoE Extender detects the existence of an IEEE 802.3at/af device, the "PoE-in-Use" LED indicator will be lit steadily, showing it is providing power.

**Note**

- If the connected device is not fully complying with IEEE 802.3at/af standard or in-line power device, the PoE-in-Use LED indicator of the Gigabit PoE Extender will not be lit steadily.
- According to IEEE 802.3at/af standard, the Gigabit PoE Extender will not inject power to the cable if not connected to a standard IEEE 802.3at/af device.

### 5.4 PoE Power Distribution

The POE-E304 can obtain a maximum of 60-watt PoE power from Ultra PoE input port and supplies a maximum of 55-watt PoE power budget to four PoE output ports, extending both the reach of **Gigabit Ethernet Data** and **IEEE 802.3at/802.3af Power over Ethernet** over the standard 100m (328 ft.) Cat 5/5e/6 UTP cable to up to 200m at the same time.

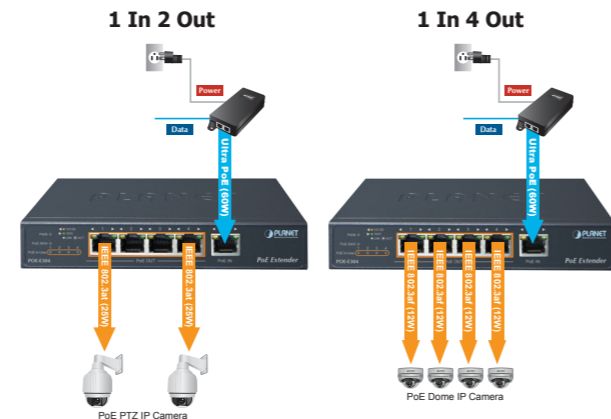

- 12 -

## Power over Ethernet POE-E304

[www.PLANET.com.tw](http://www.PLANET.com.tw)

## 1-Port Ultra PoE to 4-Port 802.3af/at Gigabit PoE Extender



PLANET Technology Corp.  
11F., No. 96, Minquan Rd., Xindian Dist., New Taipei City 231, Taiwan  
2351-AF0580-000



## 6. Power Over Ethernet Budget

The following table lists how many PoE devices can be powered by POE-E304:

Power Source	PoE Output Budget*	Max. Number of PDs supported	
IEEE 802.3at PoE+ PSE	25 watts max.	Class 4 PD@25-watt	1 unit
		Class 3 PD@15-watt	1 unit
		Class 2 PD@7-watt	3 units
PLANET 60W Ultra PoE PSE	55 watts max.	Class 4 PD@25-watt	2 units
		Class 3 PD@15-watt	3 units
		Class 2 PD@7-watt	4 units
External Power Adapter - 56V DC, 65W	55 watts max.	Class 4 PD@25-watt	2 units
		Class 3 PD@15-watt	3 units
		Class 2 PD@7-watt	4 units

**Note**

- The PoE Output Budget means the 4-port PD aggregated power output. The aggregated power consumption will be below 55 watts if with ultra PoE PSE.
- If the PoE output, whose power source is **IEEE 802.3at PoE+**, is more than 25 watts, the device will be shut down.

- 13 -

## 7. Customer Support

Thank you for purchasing PLANET products. You can browse our online FAQ resource at PLANET web site first to check if it could solve your issue. If you need more support information, please contact PLANET switch support team.

PLANET online FAQ:  
<http://www.planet.com.tw/en/support/faq.php?type=1>

Switch support team mail address:  
[support\\_switch@planet.com.tw](mailto:support_switch@planet.com.tw)

- 14 -