

# Full HD **Ultra-mini** Bullet IP Camera

**ICA-3200**



[www.planet.com.tw](http://www.planet.com.tw)

Copyright © PLANET Technology Corporation. All rights reserved.

# Presentation Outlines

- ◆ **Product Overview**
- ◆ **Product Features**
- ◆ **Product Applications**
- ◆ **Product Comparison**



**Handy**

**1080 FULL HD**

**SD Card**

**Motion detects**

**IP Surveillance**

**Full HD Ultra-mini Bullet IP Camera**

▶▶ **ICA-3200**

**ONVIF**  
Supported

# IP Surveillance - Bullet



## ◆ The PLANET Bullet IP CAM Family

- Ongoing
- Planning
- New Phase-in

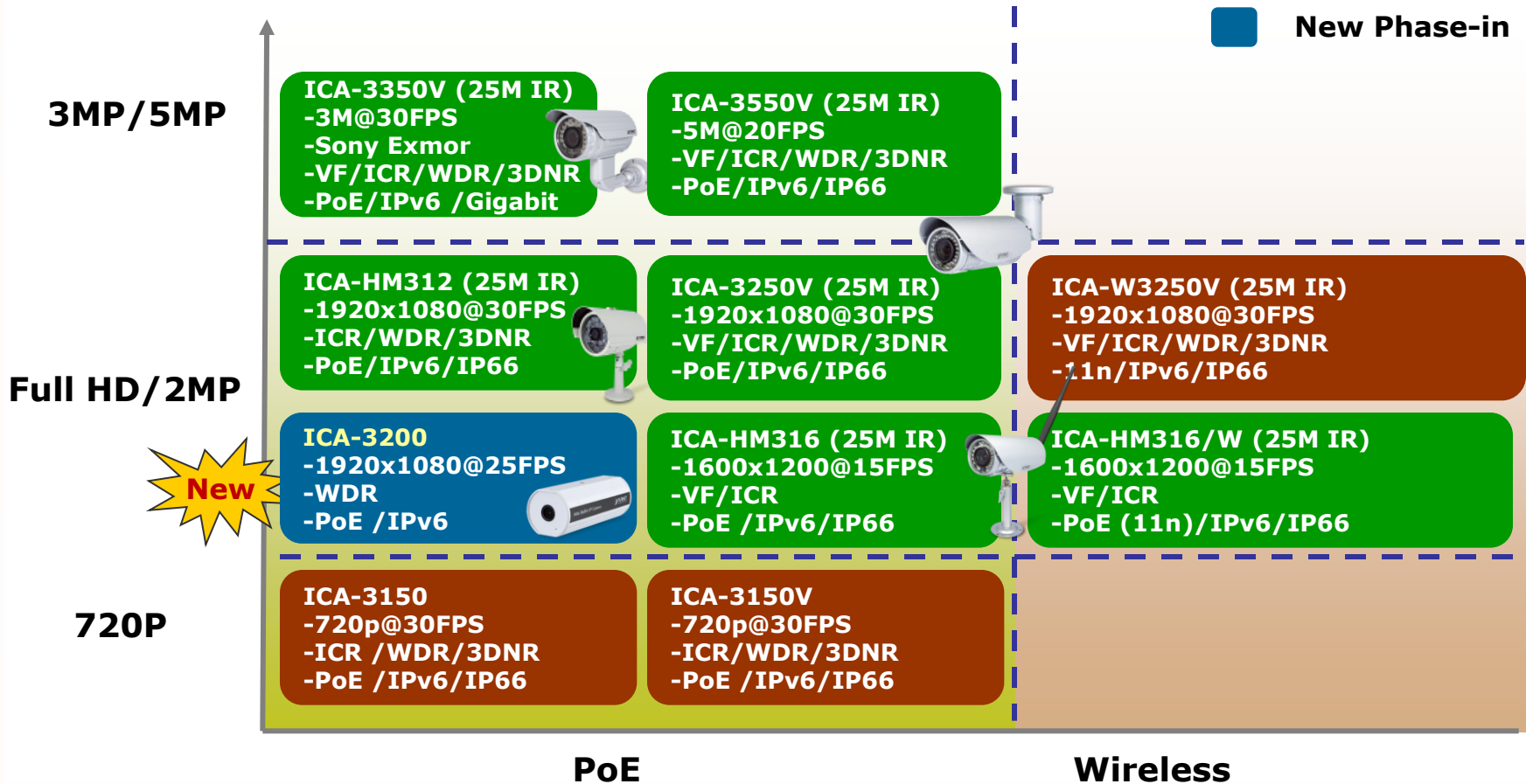

# Product Overview

## ◆ Real View of ICA-3200

Dimensions(Φ x L)	44 x 100mm
Weight	135g (gross weight)

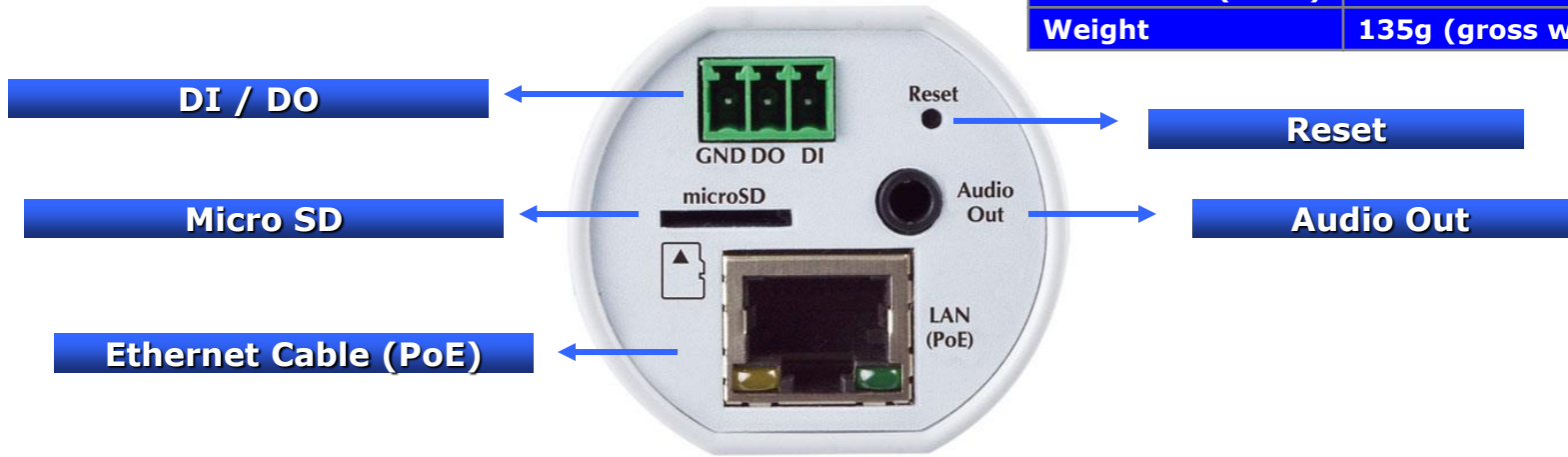

**H: 53 Degrees**  
**V: 29 Degrees**



**3.2 mm Lens**

**Microphone**

# Product Features

## ➤ Camera

- 1/3.2" progressive scan CMOS sensor
- ✓ 0.5 lux minimum illumination at F1.6
- ✓ Maximum resolution **1920 x 1080 (Full HD)**
- ✓ Convenient **nano-design** blends in nicely with any surrounding
- ✓ **Easily-recessed** mount design





# Product Features – *Full HD*

Full HD  
1080

## ◆ High-Definition Television Resolutions

- ✓ HDTV provides up to five times higher resolution than standard analog TV. Full HD also has better color fidelity and a **16:9** format.

4:3



16:9



## Product Features – *Nano-design*

### ◆ Nano-design for Easy Installation

- ✓ The ICA-3200 is an ultra lightweight IP camera in compact size, thus offering a quick and simple installation on the interior ceilings or walls of houses and buildings. Installation can be finished in less than 60 seconds.



# Product Features

## ➤ Video / Audio

- ✓ Simultaneous **H.264 / MPEG-4** and **M-JPEG** video compression
- ✓ Simultaneous **multi-stream** support
- ✓ H.264 high profile, main profile and baseline
- ✓ Max. resolution of **1080P at 25fps**
- ✓ **DNR** to improve picture quality at low lux
- ✓ **WDR** for enhancing visibility under extremely bright or dark environments
- ✓ **2-way audio** support with enhanced audio quality



# Product Features – *Multi-Profile*

## ◆ Multi-Profile

- ✓ Supporting simultaneous **multiple resolutions** and **video compressions** can generate different video streams per user's command.



**Recording**

**1920x1080 @25fps (Full HD)**



**Mobile View**

**176x144 @5fps (QCIF)**



**Remote Access**

**1280x720 @5fps (HD)**

## Product Features - **WDR**

### ◆ Exceptional Image Quality

- ✓ **WDR** (Wide Dynamic Range) for enhancing visibility under extremely bright or dark environments



# Product Features

## ◆ Supports 2-way Audio

With **2-way audio** function, IP camera becomes a bridge that helps users to talk to other people.

### *Two-Way Audio*



# Product Features

## ➤ Network and Configuration

- ✓ Compliant with **IEEE 802.3af PoE** interface for flexible deployment
- ✓ Auto MDI/MDI-X supported
- ✓ Supports both **IPv6** and **IPv4**
- ✓ Built-in **Samba** client for NAS
- ✓ **3GPP** for 3G mobile remote applications
- ✓ **RTSP / UPnP / QoS / SNMP / PPPoE / HTTPS** protocols selectable
- ✓ Access anytime, anywhere for **PLANET easy DDNS**

# Product Features - *PoE*

## ◆ Power over Ethernet

- ✓ IEEE 802.3af support enables the camera to be installed anywhere without the need for an additional power socket for the IP camera.

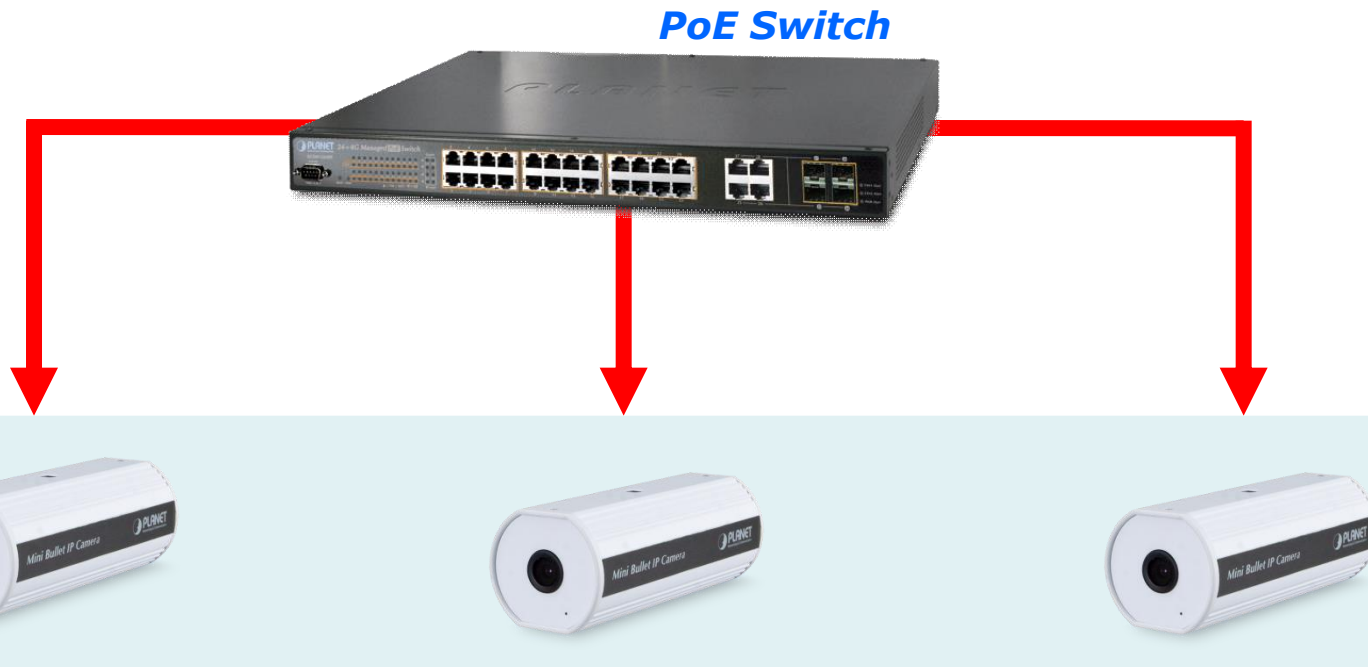

**Compliant with IEEE 802.3af standard PoE interface, these cameras can be located in any place where there are no power outlets.**



# Product Features - **PLANET DDNS**

## ◆ Access Anytime, Anywhere

Sign-in **PLANET DDNS** to register a simple domain name to access home device anytime, anywhere. **PLANET easy DDNS** lets user easily use PLANET DDNS function without manually adding new account.

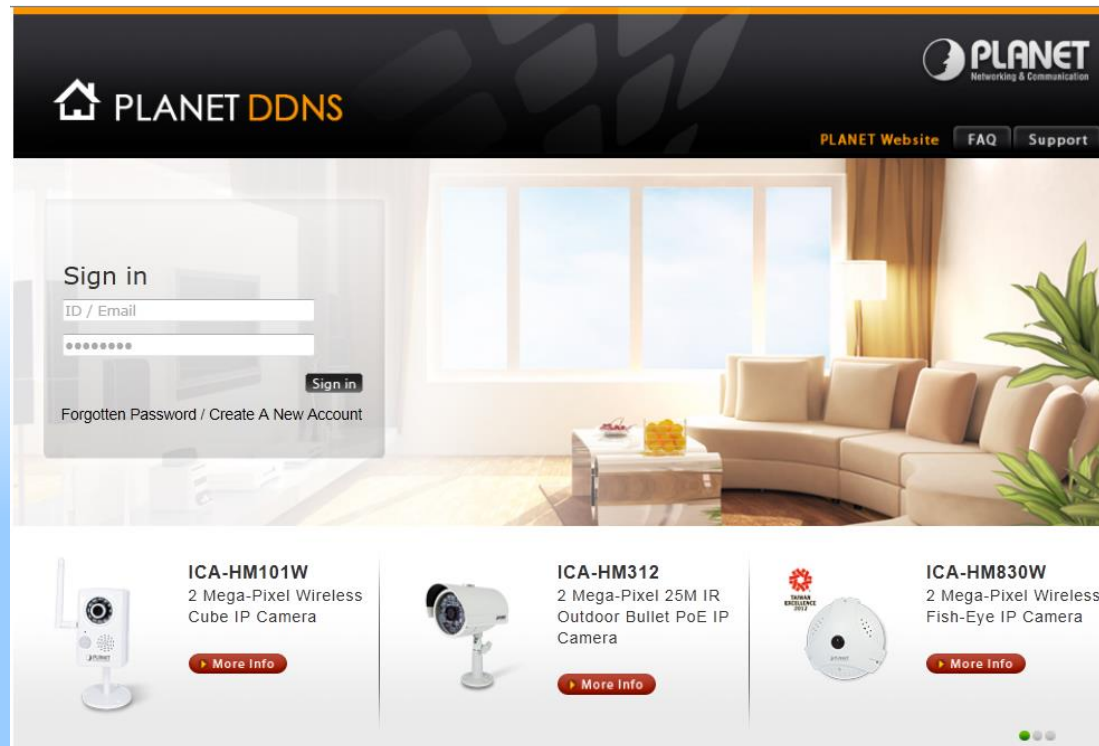

The screenshot shows the PLANET DDNS website interface. At the top, there is a dark navigation bar with the PLANET logo and 'Networking & Communication' text. Below the navigation bar, the main content area features a large background image of a modern living room with a beige sofa and a coffee table. On the left side of the main area, there is a 'Sign in' form with fields for 'ID / Email' and a password field, a 'Sign in' button, and links for 'Forgotten Password / Create A New Account'. Below the main area, there are three product cards, each with an image of a camera and a 'More Info' button. The first card is for the ICA-HM101W (2 Mega-Pixel Wireless Cube IP Camera), the second is for the ICA-HM312 (2 Mega-Pixel 25M IR Outdoor Bullet PoE IP Camera), and the third is for the ICA-HM830W (2 Mega-Pixel Wireless Fish-Eye IP Camera).

[Already a planetddns user ? Log in now](#)

# Product Features

## ➤ Easy Installation & Management

- ✓ **ONVIF** compliant for interoperability
- ✓ Tamper and motion detection for unauthorized changes
- ✓ **Micro SD card interface** for local video recording
- ✓ **Digital Input/Output** for integration with sensors and alarms
- ✓ **Cam Viewer 3** central management software supported
- ✓ Easy configuration and management via Windows-based utility or web interface



Live Demo →

Login: [guest](#) / [guest](#)

# Product Features – *DI / DO*

## ◆ Advanced Event Management

- ✓ The advanced features include Digital Input/Output for connecting to external devices such as door sensors and relays to activate light or close doors.

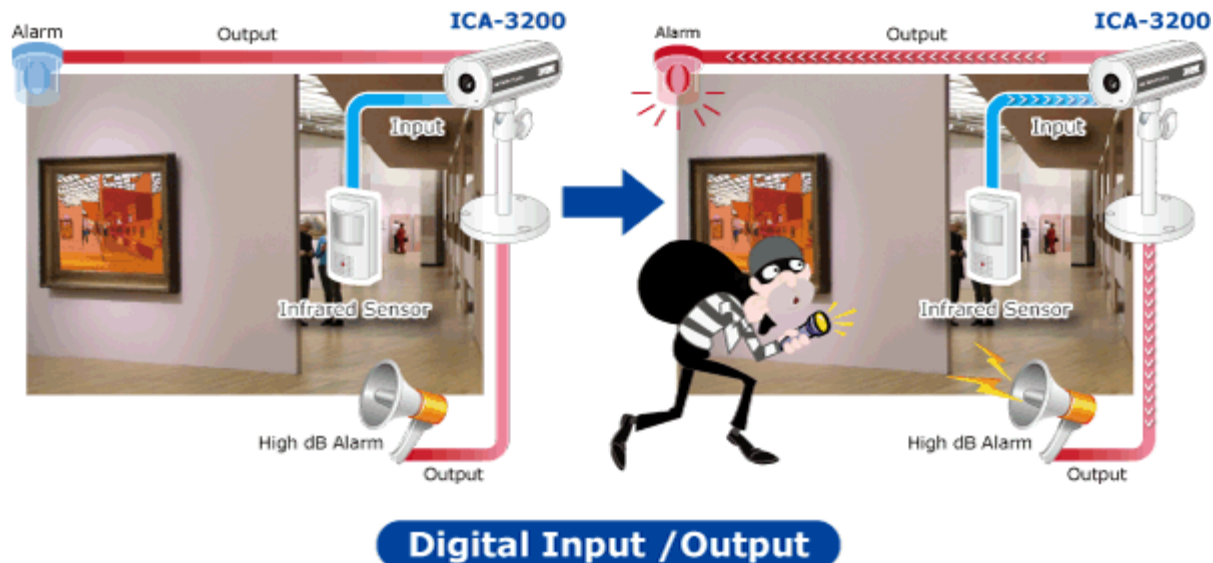

# Product Features – *Motion Detection*

## ◆ 3 Motion Detection Areas (Trigger type)

- ✓ Once there is any moving activity in a specified area, the camera can soon send a message to the manager by email or upload recording/picture onto FTP, SAMBA and email.

Event Setting

Motion Detection

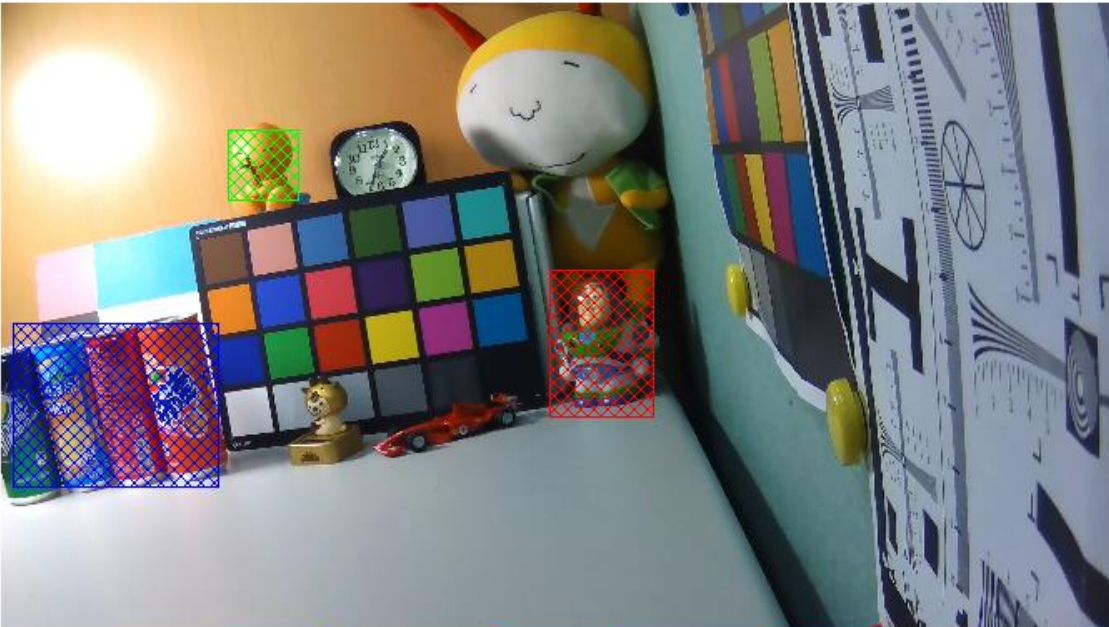

Area Setting:

Area 1	Area 2	Area 3
Sensitivity: 5	Sensitivity: 5	Sensitivity: 5



# Product Features – CV3

## ◆ CV3 Management Software

- ✓ 64-CH central management software is included for ease of maintenance and remote monitoring.





# Applications

## ◆ Providing Various Surveillance Applications

- ✓ It is perfect for remote and discreet monitoring of indoor areas such as homes, small businesses, boutiques, restaurants, hotels, residences, etc.



# Applications

## ◆ Providing Various Surveillance Applications



### Minimizes shoplifting

- Identifies shoplifters and suspicious activity
- Detects removal or loss of items



### Monitors checkout service

- Proper checkout procedures are observed
- Captures suspicious transactions

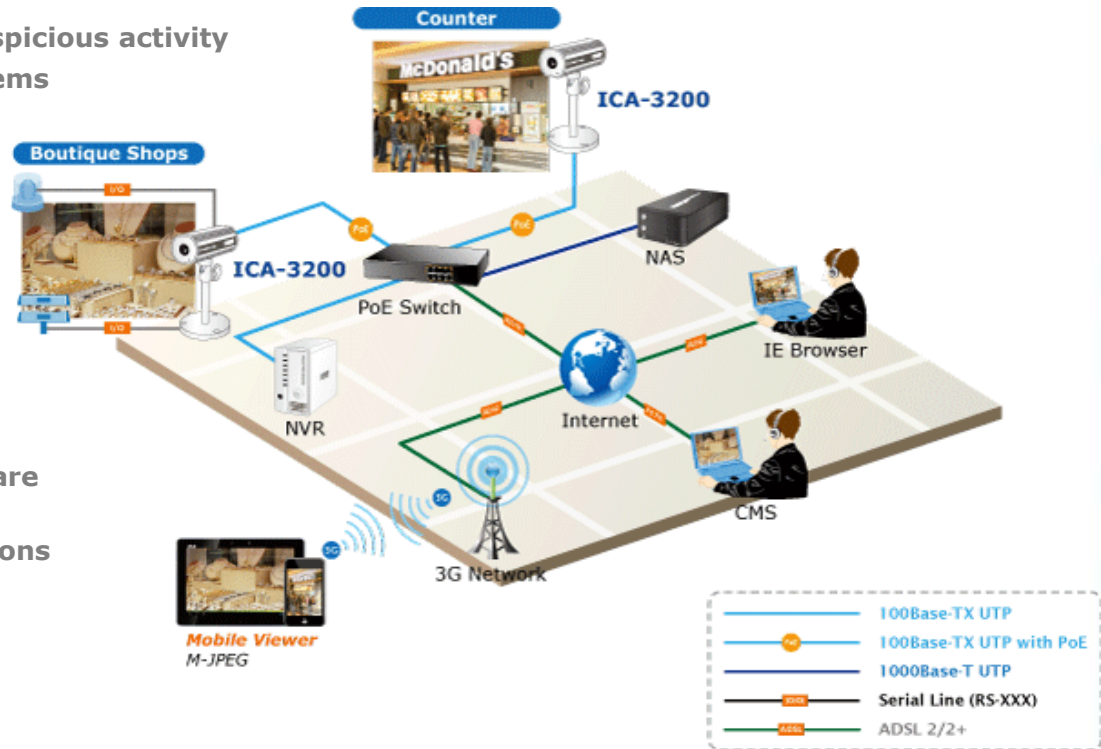

# Product Comparison

Model	PLANET ICA-3200	Sony SNCCH210/S (\$698US)	AXIS M2014-E (\$399US)
Features			
Image Sensor / Size	1/3.2" Progressive CMOS	1/2.8" Progressive CMOS	1/4" Progressive CMOS
Lens	f = 3.6mm/F1.6	f = 3.3mm/F2.8	f = 2.8mm/F2.0
Video Compression	H.264 / MPEG-4 / M-JPEG	H.264 / MPEG-4 / M-JPEG	H.264 / M-JPEG
Max. Resolution	Full HD - 1920 x 1080	Full HD - 1920 x 1080	720P - 1280 x 720
Max. Frames per Second	25	15	25
Wide Dynamic Range (WDR)	■	-	-
IPv6 / ONVIF	■	■	■
Save to NAS (Samba)	■	-	-
2-way Audio	■	-	-
DI/DO	■	-	■
Local Storage	Micro SD/SDHC card slot	-	-
PoE	IEEE 802.3af (2.88W)	IEEE 802.3af (2.4W)	IEEE 802.3af (6.49W)

# Appendix Sales Target

## ◆ Target Markets

- ✓ **SMB Office / Home Security**
- ✓ **IP Surveillance System Integrator**
- ✓ **Reseller**



## ◆ Profitable Products

- ✓ **The following are potential to all customers:**
  - ICA-HM131 / ICA-5250 – **Ultra-mini IP CAM**
  - ICA-HM312 / ICA-3250V – **Full HD Bullet IP CAM**
  - ICA-HM316 / HM316W – **2MP Bullet IP CAM**
  - ICA-3350V / ICA-3550V – **3/5MP Bullet IP CAM**
  - CV3P / NVR-420
  - NVR-810 / NVR-1610
  - NVR-3210 / NVR-3250



# Appendix

## ◆ Related Bullet IP Cameras

Model Name		Description
ICA-3200		Full HD <b>Ultra-mini</b> Bullet IP Camera
ICA-3550V		5 <b>Mega-pixel</b> Outdoor IR PoE IP Camera
ICA-3250V		Full HD Outdoor IR PoE IP Camera
ICA-3350V		3 <b>Mega-pixel</b> Vari-focal Bullet IR IP Camera
ICA-HM316		2 <b>Mega-pixel</b> Outdoor IR <b>PoE</b> IP Camera
ICA-HM316W		2 <b>Mega-pixel</b> <b>11n</b> Outdoor IR IP Camera
ICA-HM312		2 <b>Mega-pixel</b> 25M IR Outdoor Bullet PoE IP Camera



# Appendix

## ◆ Camera Naming Rule

# ICA-3200

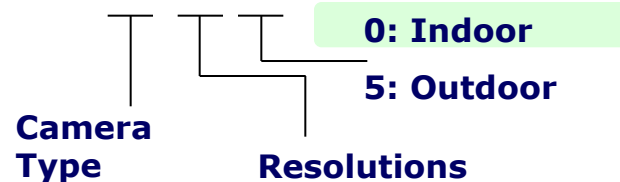

## Wireless Function

- Wi-Fi – W

## Camera Type

- Cube – 1
- Box – 2
- **Bullet – 3**
- Dome – 4
- Vandal Dome – 5
- Speed Dome – 6
- PTZ – 7
- Fisheye – 8

## Resolutions

- VGA / D1 - 0
- 1M / 720P - 1
- **2M (Full HD) - 2**
- 3MP - 3
- 4MP - 4
- 5MP - 5

## Camera Function

- Vari-focal – V
- Industrial – T

# Appendix Must Know

## ◆ Technical Zone

### ✓ Bandwidth and Video Size Estimation

- The frame rate of video transmitted from the Internet Camera depends on connection bandwidth between client and server, video resolution, codec type, and quality setting of server. Here is a guideline to help you roughly estimate the bandwidth requirements for your Internet Camera.
- The required bandwidth depends on content of video source. The slow motion video will produce smaller bit rate generally and fast motion will produce higher bit rate vice versa. Actual results generated by the Internet Camera may be varying.

Image Resolution	Average range of data sizes for JPEG mode	Average bit rate for MPEG4 mode	Average bit rate for H.264 mode
320 x 240	8 ~ 20k byte per frame	256kbps~768kbps @ 30fps	192kbps~512kbps @ 30fps
640 x 480	20 ~ 50K byte per frame	512kbps~3072kbps @ 30fps	384kbps~1536kbps @ 30fps
1920 x 1080 Full HD	200 ~ 500k byte per frame	-	1536kbps~10000kbps @ 30fps
2048 x 1536 3 MP	300 ~ 750k byte per frame	-	2048kbps~12000kbps @ 30fps



# **ACTIVATING IP POWER**